

# Xtra Long Life SPDT Switch

50Ω DC to 18 GHz 12 Volt Reflective

## MSP2T-18-12+



Generic photo used for illustration purposes only

CASE STYLE: FK811

Connectors	Model
SMA	MSP2T-18-12+

**+RoHS Compliant**

The +Suffix identifies RoHS Compliance. See our web site for RoHS Compliance methodologies and qualifications

### Maximum Ratings

Operating Temperature	-15°C to +45°C
Storage Temperature	-15°C to +85°C
RF Power (any single port)	10W
Control Voltage	13VDC
Permanent damage may occur if any of these limits are exceeded.	

### Features

- low voltage operation, 12V
- low insertion loss, 0.25 dB typ.
- high isolation, 80 dB typ.
- high power handling, 10W
- ultra reliable
- break-before-make configuration
- reflective failsafe switch
- protected by US Patents 5,272,458; 6,414,577; 6,650,210; 7,633,361; 7,843,289

### Applications

- Automatic Test Equipment (ATE)
- reliable "sleeptime" switching
- redundancy switching for microwave radio

### Outline Drawing

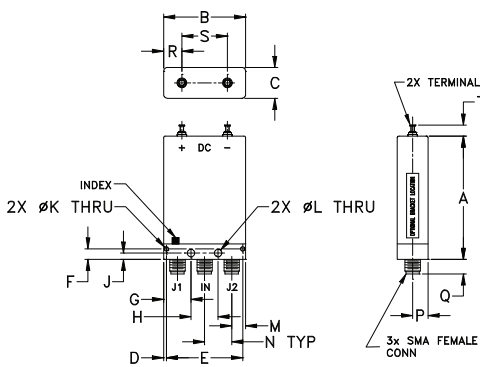

### Outline Dimensions (inch/mm)

A	B	C	D	E	F	G	H	J	K
2.00	1.34	.50	.045	1.240	.170	.445	.440	.103	.070
50.80	34.04	12.70	1.14	31.50	4.32	11.30	11.18	2.62	1.78

L	M	N	P	Q	R	S	T	wt
.120	.230	.440	.25	.24	.297	.740	.19	grams
3.05	5.84	11.18	6.35	6.10	7.54	18.80	4.83	41.0

### Marking Drawing

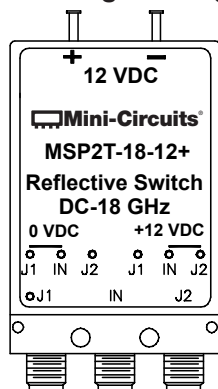

### Electrical Specifications

Parameter	Condition (GHz)	Min.	Typ. (Note 1)	Max.	Unit
<b>Frequency Range</b>		DC	—	18	GHz
<b>Insertion Loss</b>	DC - 1	—	0.10	0.15	dB
	1 - 8	—	0.20	0.30	
	8 - 12	—	0.25	0.35	
<b>Isolation</b>	DC - 1	85	100	—	dB
	1 - 8	75	90	—	
	8 - 12	70	80	—	
<b>VSWR (Note 2)</b>	DC - 1	—	1.05	1.10	:1
	1 - 8	—	1.20	1.35	
	8 - 12	—	1.20	1.35	
<b>DC Current @ +12V (Note 3)</b>	DC - 18	—	180	230	mA
<b>RF Power Cold Switching</b>	DC - 18	—	—	10	W
<b>RF Power Hot Switching</b>	0.1W	10 million	—	—	Cycles
	1.0W	—	1 million	—	

### Notes

1. The performance values represents a common value for the frequency range. For typical performance across the frequency band, see performance graphs in the next page.
2. All ports, all states.
3. +12 Volt applied to energized port, COM is negative.

### Additional Specifications

Operating Voltage Range	12V (nom) ±0.5V
Switching Time (Typ.)	20ms

### Switching States

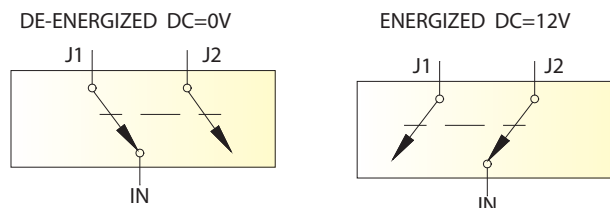

### Notes

- A. Performance and quality attributes and conditions not expressly stated in this specification document are intended to be excluded and do not form a part of this specification document.
- B. Electrical specifications and performance data contained in this specification document are based on Mini-Circuit's applicable established test performance criteria and measurement instructions.
- C. The parts covered by this specification document are subject to Mini-Circuits standard limited warranty and terms and conditions (collectively, "Standard Terms"); Purchasers of this part are entitled to the rights and benefits contained therein. For a full statement of the Standard Terms and the exclusive rights and remedies thereunder, please visit Mini-Circuits' website at [www.minicircuits.com/WCLStore/terms.jsp](http://www.minicircuits.com/WCLStore/terms.jsp)



## Typical Performance Data

FREQ. (MHz)	ON INSERTION LOSS (dB)		OFF ISOLATION (dB)		VSWR, IN (:1)		VSWR (J1, J2) (:1)	
	IN-J1	IN-J2	IN-J1	IN-J2	De- Energized	Energized	(J1) De-	(J2)
							Energized	Energized
10.0	0.00	0.01	85.77	94.22	1.00	1.01	1.01	1.00
100.0	0.01	0.01	102.87	105.34	1.00	1.00	1.00	1.00
1000.0	0.04	0.04	115.37	105.64	1.01	1.01	1.01	1.01
2000.0	0.06	0.06	115.69	98.42	1.02	1.02	1.02	1.02
3000.0	0.07	0.07	107.32	105.01	1.06	1.06	1.06	1.06
4000.0	0.09	0.10	103.20	113.10	1.12	1.12	1.12	1.12
5000.0	0.12	0.12	104.85	109.83	1.18	1.18	1.18	1.18
6000.0	0.13	0.14	102.48	103.47	1.20	1.21	1.21	1.20
7000.0	0.14	0.14	112.75	105.01	1.18	1.19	1.19	1.18
8000.0	0.14	0.14	98.41	96.58	1.14	1.15	1.15	1.14
9000.0	0.13	0.14	96.65	96.81	1.10	1.11	1.11	1.10
10000.0	0.14	0.14	96.31	96.57	1.08	1.08	1.09	1.08
11000.0	0.15	0.16	92.76	93.91	1.09	1.10	1.10	1.10
12000.0	0.17	0.18	88.40	90.44	1.14	1.14	1.14	1.14
13000.0	0.18	0.20	87.03	89.57	1.17	1.18	1.18	1.17
14000.0	0.20	0.21	84.38	85.14	1.18	1.19	1.19	1.18
15000.0	0.20	0.22	82.56	83.98	1.16	1.18	1.18	1.16
16000.0	0.21	0.23	81.52	83.15	1.13	1.16	1.17	1.14
17000.0	0.22	0.24	78.85	80.32	1.13	1.16	1.16	1.15
18000.0	0.24	0.28	75.92	77.77	1.19	1.18	1.19	1.19

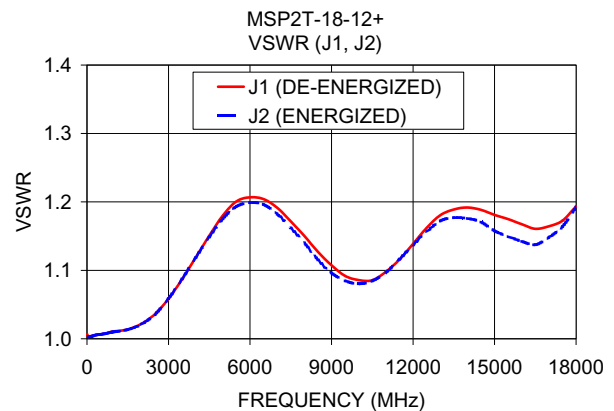
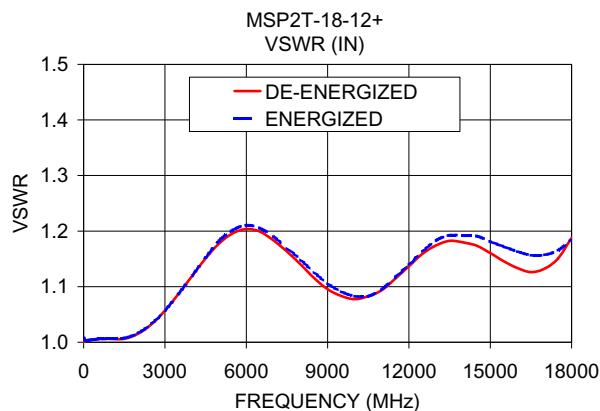
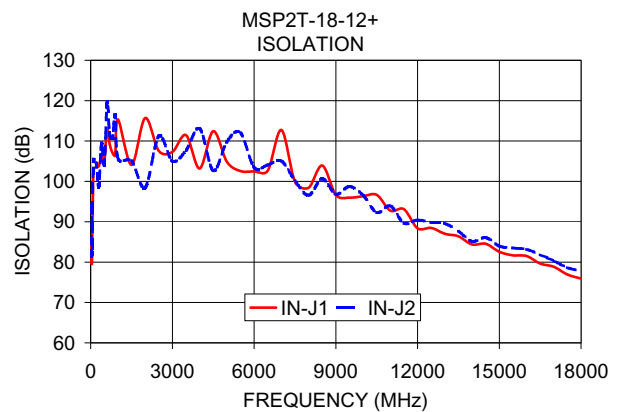
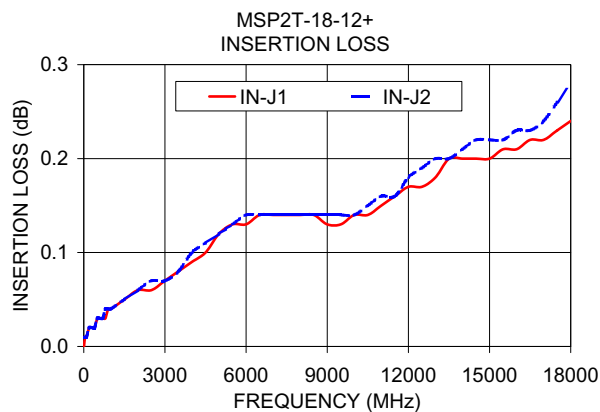

### Notes

- Performance and quality attributes and conditions not expressly stated in this specification document are intended to be excluded and do not form a part of this specification document.
- Electrical specifications and performance data contained in this specification document are based on Mini-Circuit's applicable established test performance criteria and measurement instructions.
- The parts covered by this specification document are subject to Mini-Circuits standard limited warranty and terms and conditions (collectively, "Standard Terms"); Purchasers of this part are entitled to the rights and benefits contained therein. For a full statement of the Standard Terms and the exclusive rights and remedies thereunder, please visit Mini-Circuits' website at [www.minicircuits.com/MCLStore/terms.jsp](http://www.minicircuits.com/MCLStore/terms.jsp)



# Xtra Long Life SPDT Switch

# MSP2T-18-12+

## Typical Performance Data

FREQUENCY (MHz)	INSERTION LOSS ON (dB)		ISOLATION OFF (dB)		VSWR (IN) (:1)		VSWR (J1, J2) (:1)	
	IN-J1	IN-J2	IN-J1	IN-J2	DE-ENERGIZED	ENERGIZED	J1 (DE-ENERGIZED)	J2 (ENERGIZED)
10.0	0.00	0.01	85.77	94.22	1.00	1.01	1.01	1.00
50.0	0.01	0.01	80.19	81.56	1.00	1.00	1.00	1.00
100.0	0.01	0.01	102.87	105.34	1.00	1.00	1.00	1.00
200.0	0.02	0.02	103.54	104.47	1.00	1.00	1.00	1.00
300.0	0.02	0.02	103.80	98.70	1.00	1.00	1.01	1.01
400.0	0.02	0.02	106.10	109.43	1.00	1.01	1.01	1.01
500.0	0.03	0.03	104.89	104.11	1.01	1.01	1.01	1.01
600.0	0.03	0.03	113.07	119.59	1.01	1.01	1.01	1.01
700.0	0.03	0.03	109.24	111.44	1.01	1.01	1.01	1.01
800.0	0.03	0.04	107.06	110.58	1.01	1.01	1.01	1.01
900.0	0.04	0.04	106.40	116.55	1.01	1.01	1.01	1.01
1000.0	0.04	0.04	115.37	105.64	1.01	1.01	1.01	1.01
1500.0	0.05	0.05	104.09	105.11	1.01	1.01	1.01	1.01
2000.0	0.06	0.06	115.69	98.42	1.02	1.02	1.02	1.02
2500.0	0.06	0.07	107.56	111.22	1.03	1.03	1.04	1.04
3000.0	0.07	0.07	107.32	105.01	1.06	1.06	1.06	1.06
3500.0	0.08	0.08	111.45	107.63	1.09	1.09	1.09	1.09
4000.0	0.09	0.10	103.20	113.10	1.12	1.12	1.12	1.12
4500.0	0.10	0.11	112.45	102.66	1.15	1.15	1.15	1.15
5000.0	0.12	0.12	104.85	109.83	1.18	1.18	1.18	1.18
5500.0	0.13	0.13	102.58	112.03	1.20	1.20	1.20	1.19
6000.0	0.13	0.14	102.48	103.47	1.20	1.21	1.21	1.20
6500.0	0.14	0.14	102.68	104.06	1.20	1.21	1.20	1.20
7000.0	0.14	0.14	112.75	105.01	1.18	1.19	1.19	1.18
7500.0	0.14	0.14	99.92	100.16	1.16	1.17	1.17	1.16
8000.0	0.14	0.14	98.41	96.58	1.14	1.15	1.15	1.14
8500.0	0.14	0.14	103.94	100.63	1.12	1.13	1.13	1.12
9000.0	0.13	0.14	96.65	96.81	1.10	1.11	1.11	1.10
9500.0	0.13	0.14	95.98	98.71	1.08	1.09	1.09	1.08
10000.0	0.14	0.14	96.31	96.57	1.08	1.08	1.09	1.08
10500.0	0.14	0.15	96.65	92.30	1.08	1.08	1.09	1.08
11000.0	0.15	0.16	92.76	93.91	1.09	1.10	1.10	1.10
11500.0	0.16	0.16	93.10	89.62	1.11	1.12	1.12	1.12
12000.0	0.17	0.18	88.40	90.44	1.14	1.14	1.14	1.14
12500.0	0.17	0.19	88.47	89.82	1.16	1.16	1.16	1.16
13000.0	0.18	0.20	87.03	89.57	1.17	1.18	1.18	1.17
13500.0	0.20	0.20	86.41	87.69	1.18	1.19	1.19	1.18
14000.0	0.20	0.21	84.38	85.14	1.18	1.19	1.19	1.18
14500.0	0.20	0.22	84.54	86.06	1.17	1.19	1.19	1.17
15000.0	0.20	0.22	82.56	83.98	1.16	1.18	1.18	1.16
15500.0	0.21	0.22	81.69	83.51	1.15	1.17	1.17	1.15
16000.0	0.21	0.23	81.52	83.15	1.13	1.16	1.17	1.14
16500.0	0.22	0.23	79.64	81.85	1.13	1.16	1.16	1.14
17000.0	0.22	0.24	78.85	80.32	1.13	1.16	1.16	1.15
17500.0	0.23	0.26	76.93	78.63	1.15	1.17	1.17	1.16
18000.0	0.24	0.28	75.92	77.77	1.19	1.18	1.19	1.19



P.O. Box 350166, Brooklyn, New York 11235-0003 (718) 934-4500 • Fax (718) 332-4661 For detailed performance specs & shopping online see Mini-Circuits web site **MSP2T-18-12+**



The Design Engineers Search Engine Provides ACTUAL Data Instantly From MINI-CIRCUITS At: [www.minicircuits.com](http://www.minicircuits.com)

IF/RF MICROWAVE COMPONENTS

REV. OR

MSP2T-18-12+

3/21/2013

Page 1 of 1

# Xtra Long Life SPDT Switch

# MSP2T-18-12+

## Typical Performance Curves

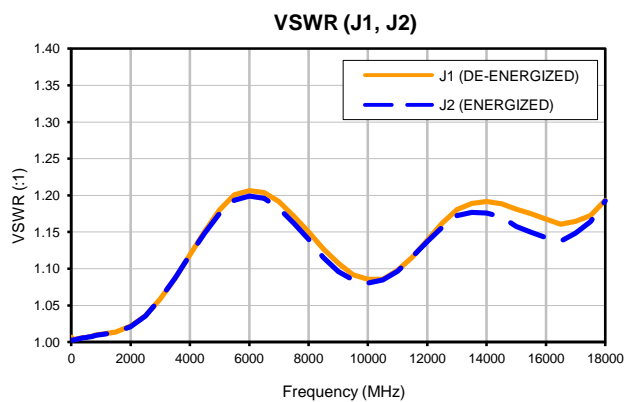
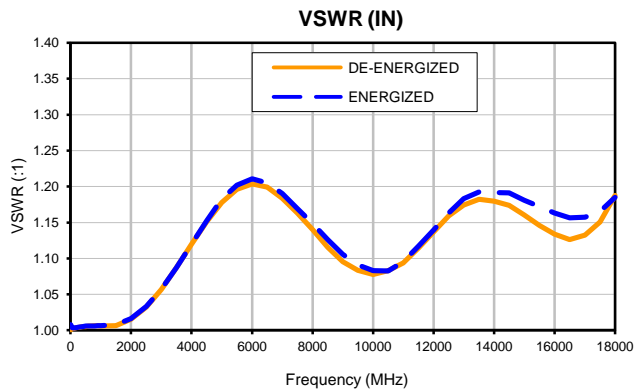
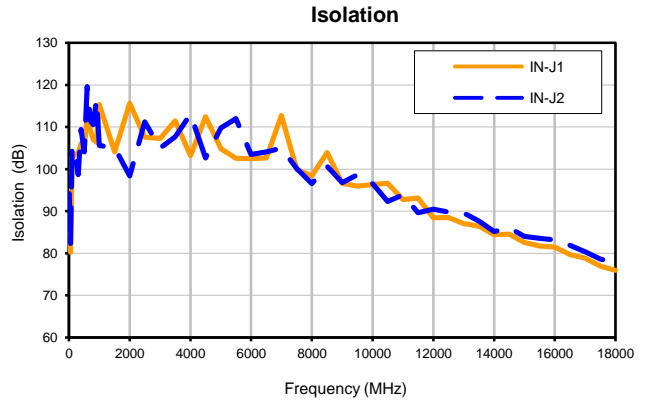
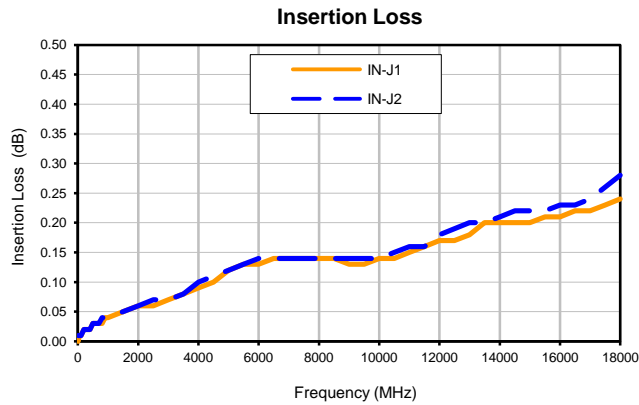

### Outline Dimensions

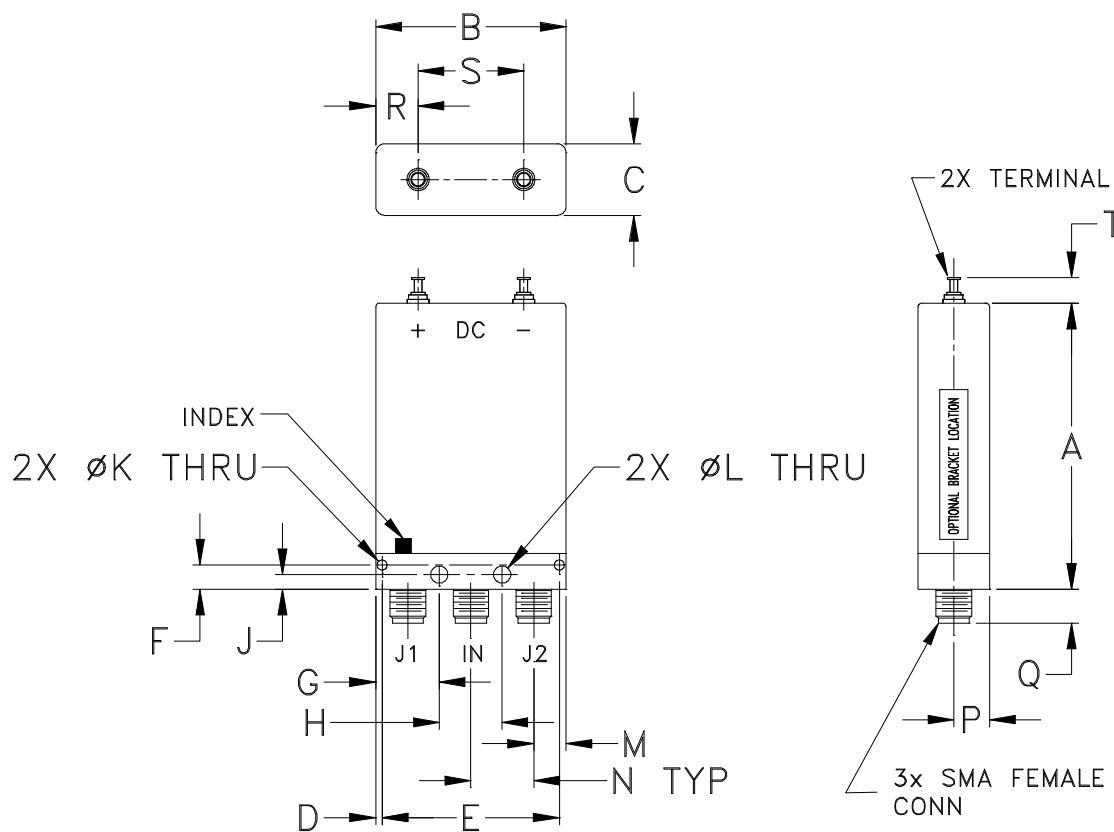

CASE #.	A	B	C	D	E	F	G	H	J	K	L	M	N	P
FK811	2.00 (50.80)	1.34 (34.04)	.50 (12.70)	.045 (1.14)	1.240 (31.50)	.170 (4.32)	.445 (11.30)	.440 (11.18)	.103 (2.62)	.070 (1.78)	.120 (3.05)	.230 (5.84)	.440 (11.18)	.25 (6.35)

CASE #.	Q	R	S	T	WT, GRAM
FK811	.24 (6.10)	.297 (7.54)	.740 (18.80)	.19 (4.83)	41

Dimensions are in inches (mm). Tolerances: 2Pl.  $\pm .03$ ; 3Pl.  $\pm .015$

#### Note:

- Case material: Copper-Nickel alloy.



INTERNET <http://www.minicircuits.com>

P.O. Box 350166, Brooklyn, New York 11235-0003 (718) 934-4500 Fax (718) 332-4661

Distribution Centers NORTH AMERICA 800-654-7949 • 417-335-5935 • Fax 417-335-5945 • EUROPE 44-1252-832600 • Fax 44-1252-837010

Mini-Circuits ISO 9001 & ISO 14001 Certified

All Mini-Circuits products are manufactured under exacting quality assurance and control standards, and are capable of meeting published specifications after being subjected to any or all of the following physical and environmental test.

Specification	Test/Inspection Condition	Reference/Spec
Operating Temperature	-15° to 45°C Ambient Environment	Individual Model Data Sheet
Storage Temperature	-15° to 85°C Ambient Environment	Individual Model Data Sheet
Humidity	90 to 95% RH, 96 hours, 40°C	MIL-STD-202, Method 103B, Condition B, Except 50°C
Thermal Shock	-55° to 100°C, 50 cycles	MIL-STD-202, Method 107, Condition B, except -55° to +100°C and 50 cycles
Vibration (High Frequency)	0.06-inch double amplitude, 10-55 Hz, 2 hours in each of three perpendicular directions (total 6 hours)	MIL-STD-202, Method 204, Condition C, Part 1
Mechanical Shock	50G, 11 ms sawtooth, 18 shocks: 3 each direction, each of 3 axes	MIL-STD-202, Method 213, Condition G
Marking Resistance to Solvents	Isopropyl alcohol + mineral spirits at 25°C; terpene defluxer at 25°C; distilled water + proylene glycol monomethyl ether + monoethanolamine at 63°C to 70°C	MIL-STD-202, Method 215