

# SPDT RF SWITCH

50Ω DC-3000 MHz

Absorptive RF Switch with internal driver.  
Single Supply Voltage

## Product Features

- Low Insertion loss over entire frequency range
- Super High Isolation over entire frequency range
- High Input IP3, +55 dBm typ.
- Single positive supply voltage, +2.7V to +5V
- Unique design-simultaneous switch off of RF1&RF2
- Rigid unibody case

## Typical Applications

- Lab
- Instrumentation
- Test equipment

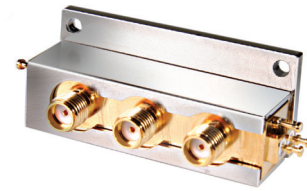

## ZX80-DR230+

CASE STYLE: HL1162

Connectors	Order P/N
SMA	ZX80-DR230-S+

**+RoHS Compliant**

The +Suffix identifies RoHS Compliance. See our web site for RoHS Compliance methodologies and qualifications

## General Description

The ZX80-DR230+ is a 50Ω high isolation SPDT RF switch designed for wireless applications, covering a broad frequency range from DC up to 3GHz with low insertion loss. The ZX80-DR230+ operates on a single supply voltage from +2.7V to +5V. This unit includes an internal CMOS control driver with two-pins control. The ZX80-DR230+ is produced using a unique case package for ruggedness and operation in tough environments.

## Functional Diagram

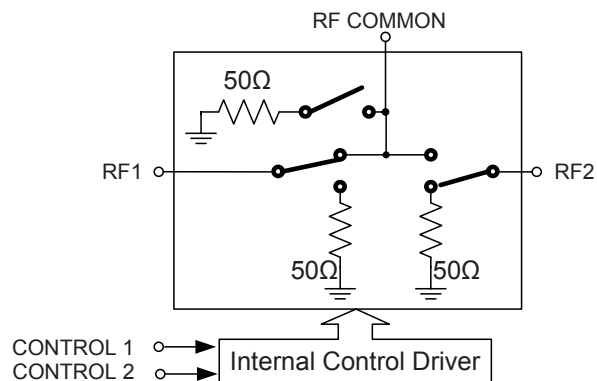

Parameter	Condition	Min.	Typ.	Max.	Units
Operating Frequency		DC <sup>(note 3)</sup>		3000	MHz
Insertion Loss	1 GHz		0.7	1.3	dB
	2 GHz		0.9	1.6	
	3 GHz		1.2	1.8	
Isolation between Common port and RF1/RF2 ports	1 GHz	55	64		dB
	2 GHz	46	50		
	3 GHz	35	44		
Isolation between RF1 and RF2 ports	1 GHz	60	63		dB
	2 GHz	54	60		
	3 GHz	37	48		
Return Loss @ Common port	1 GHz		20		dB
	2 GHz		17		
	3 GHz		15		
Return Loss @ RF1/RF2 ports	1 GHz		17		dB
	2 GHz		15		
	3 GHz		15		
Input IP2 <sup>(note 1)</sup>	5 MHz - 1000 MHz		+80		dBm
Input IP3 <sup>(note 1)</sup>	10 MHz - 3000MHz		+55		dBm
Input 1dB Compression <sup>(note 1,2)</sup>	1000 MHz	+28	+31		dBm

**Notes:**

1. Device linearity degrades below 1 MHz.
2. Note absolute maximum ratings for input power.
3. Lowest Freq. determined by value of coupling capacitors at RF ports.

## DC Electrical Specifications

Parameter	Min.	Typ.	Max.	Units
V <sub>DD</sub> , Supply Voltage	2.7	-	5.0	V
Supply Current (V <sub>DD</sub> = 5V)	—	0.5	1.0	mA
Control Voltage Low	0	—	0.4	V
Control Voltage High	2.4	—	V <sub>DD</sub>	V
Control Current (per pin)	—	0.5	1.0	mA

## Switching Specifications

Parameter	Min.	Typ.	Max.	Units
Switching Time, 50% CTRL to 90/10% RF	—	2.0	—	μSec
Video Feedthrough, 5 MHz - 1000 MHz <sup>(note 4)</sup>	—	—	15	mV <sub>p-p</sub>

Note 4: Measured with a 1 nSec risetime, 0/3V pulse and 500 MHz bandwidth.

## Absolute Maximum Ratings

Parameter	Ratings
Operating Temperature	-40°C to 85°C
Storage Temperature	-55°C to 100°C
V <sub>DD</sub> , Supply Voltage	-0.3V Min. 6V Max.
Control Voltage	-0.3V Min. 6V Max.
ESD, HBM	1000V
RF input power: <sup>(note 5)</sup>	
When the common port is connected to the RF port (RF1 or RF2)	+33dBm
When the RF port (RF1 or RF2) is not connected to the common port	+24dBm
When the common port is not connected to either RF1 or RF2	+24dBm

Note 5: See Truth Table on page 3.

**Notes**

- Performance and quality attributes and conditions not expressly stated in this specification document are intended to be excluded and do not form a part of this specification document.
- Electrical specifications and performance data contained in this specification document are based on Mini-Circuit's applicable established test performance criteria and measurement instructions.
- The parts covered by this specification document are subject to Mini-Circuits standard limited warranty and terms and conditions (collectively, "Standard Terms"); Purchasers of this part are entitled to the rights and benefits contained therein. For a full statement of the Standard Terms and the exclusive rights and remedies thereunder, please visit Mini-Circuits' website at [www.minicircuits.com/MCLStore/terms.jsp](http://www.minicircuits.com/MCLStore/terms.jsp)



The RF switch control bits select the desired switch-state, as shown in **Table 1**: Truth Table.

**Table 1: Truth Table.**

STATE	Control Input		RF Input / Output	
	Control 1	Control 2	RF1 to RF COMMON	RF2 to RF COMMON
1	Low	Low	OFF	OFF
2	Low	High	OFF	ON
3	High	Low	ON	OFF
4	High	High	N/A	N/A

**General notes:**

1. When either of the RF1 or RF2 ports is closed (**ON** state), the closed port is connected to the RF Common port.
2. When either of the RF1 or RF2 ports is open (**OFF** state), the open port is connected to an internal 50Ω termination.
3. When both RF1 and RF2 ports are open (**OFF** state), the all three RF ports are connected to an internal 50Ω termination.

**EXAMPLE OF STATE 3**

**Functional Diagram**

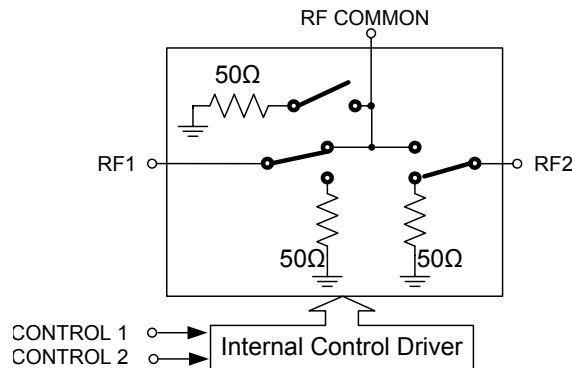

**Pin Description**

Function	Connection Number	Description
RF2	J1	RF I/O (note 1)
RF COM	J2	RF Common (note 1)
RF1	J3	RF I/O (note 1)
Control 1	P1	Control 1
GND	P2	Ground
Control 2	P3	Control 2
GND	P4	Ground
VDD	P5	Supply voltage

**Pin Configuration**

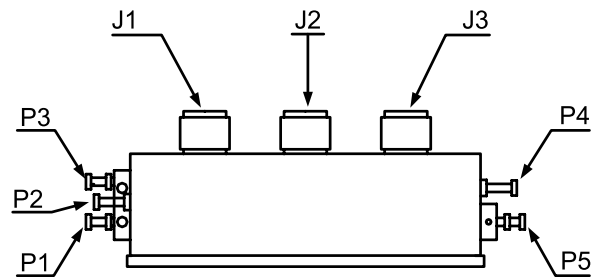

Note 1: RF ports J1, J2 and J3 must be at 0 VDC. The RF ports do not require DC blocking capacitors for proper operation if the 0 VDC requirement is met.

**!** NOTE: When soldering the DC connections, caution must be used to avoid overheating the DC terminals. See Application Note [AN-40-10](#).

**Notes**

- A. Performance and quality attributes and conditions not expressly stated in this specification document are intended to be excluded and do not form a part of this specification document.
- B. Electrical specifications and performance data contained in this specification document are based on Mini-Circuits' applicable established test performance criteria and measurement instructions.
- C. The parts covered by this specification document are subject to Mini-Circuits standard limited warranty and terms and conditions (collectively, "Standard Terms"); Purchasers of this part are entitled to the rights and benefits contained therein. For a full statement of the Standard Terms and the exclusive rights and remedies thereunder, please visit Mini-Circuits' website at [www.minicircuits.com/MCLStore/terms.jsp](http://www.minicircuits.com/MCLStore/terms.jsp)



Typical Performance Curves over various states. For switch state see Truth Table 1 on page 3.

INSERTION LOSS Vs. FREQUENCY @ +25°C

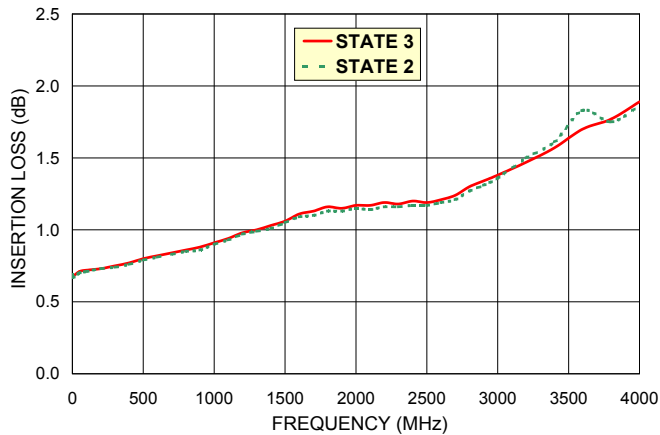

INSERTION LOSS Vs. FREQUENCY

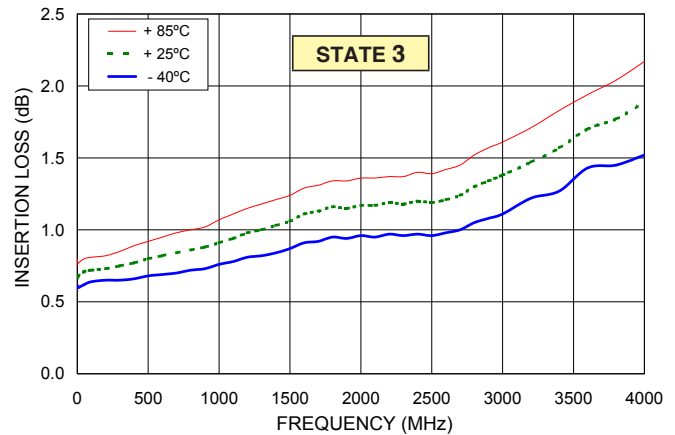

ISOLATION BETWEEN RF1 TO RF COM Vs. FREQUENCY

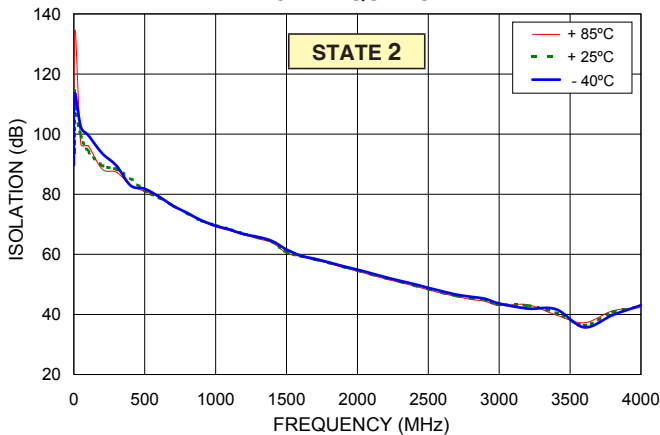

ISOLATION BETWEEN RF2 TO RF COM Vs. FREQUENCY

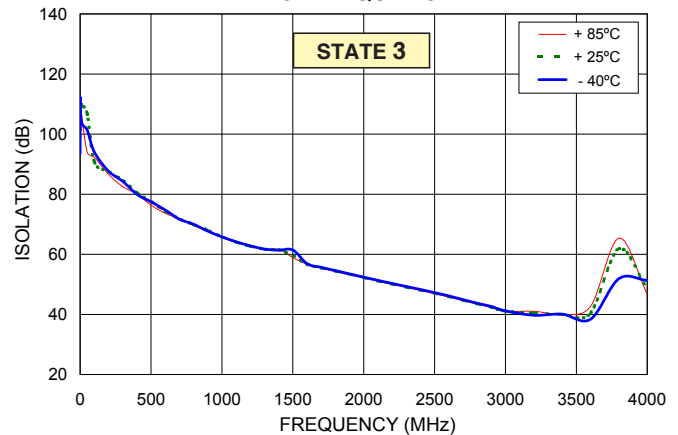

ISOLATION BETWEEN RF1 TO RF2 Vs. FREQUENCY

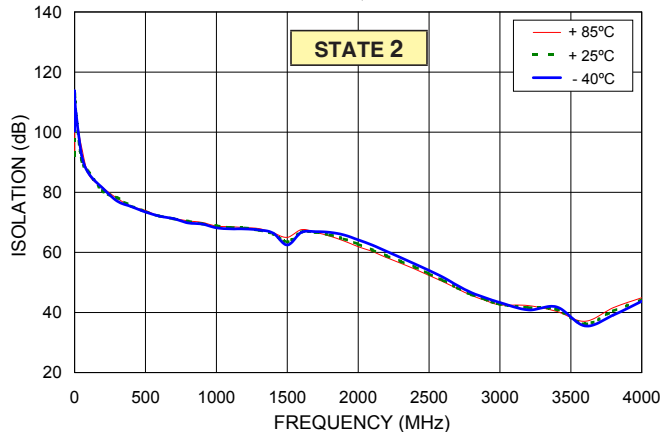

ISOLATION BETWEEN RF1 TO RF2 Vs. FREQUENCY

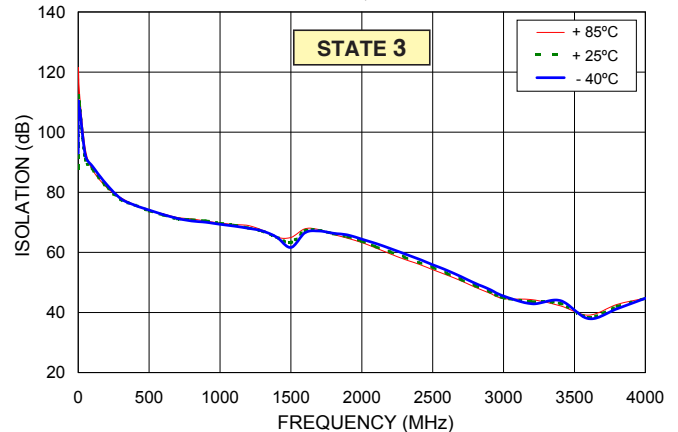

**Notes**

- A. Performance and quality attributes and conditions not expressly stated in this specification document are intended to be excluded and do not form a part of this specification document.
- B. Electrical specifications and performance data contained in this specification document are based on Mini-Circuit's applicable established test performance criteria and measurement instructions.
- C. The parts covered by this specification document are subject to Mini-Circuits standard limited warranty and terms and conditions (collectively, "Standard Terms"); Purchasers of this part are entitled to the rights and benefits contained therein. For a full statement of the Standard Terms and the exclusive rights and remedies thereunder, please visit Mini-Circuits' website at [www.minicircuits.com/MCLStore/terms.jsp](http://www.minicircuits.com/MCLStore/terms.jsp)



Typical Performance Curves over various states. For switch state see Truth Table 1 on page 3.

ISOLATION BETWEEN RF1/RF2 TO RF COM  
Vs. FREQUENCY

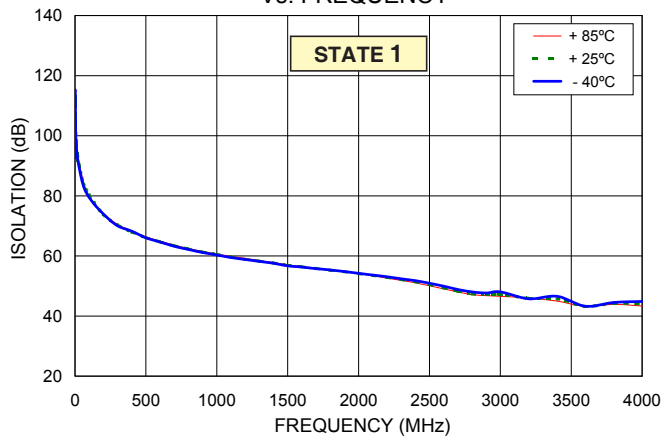

ISOLATION BETWEEN RF1 TO RF2  
Vs. FREQUENCY

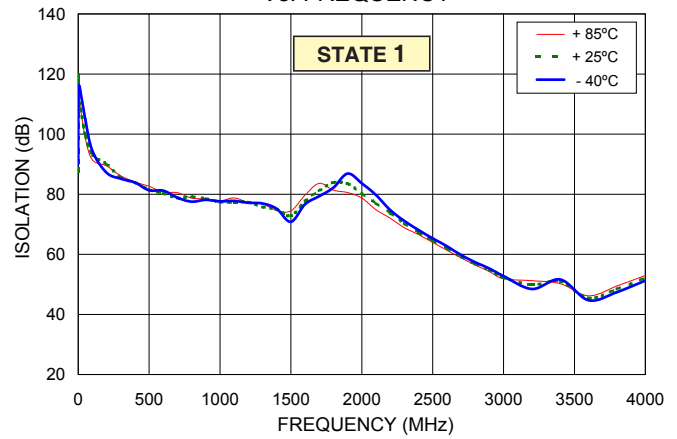

RF RETURN LOSS Vs. FREQUENCY @ +25°C

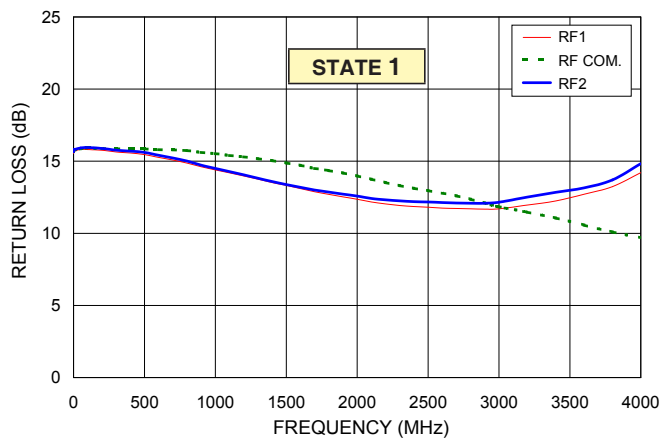

RF COM RETURN LOSS Vs. FREQUENCY @ +25°C

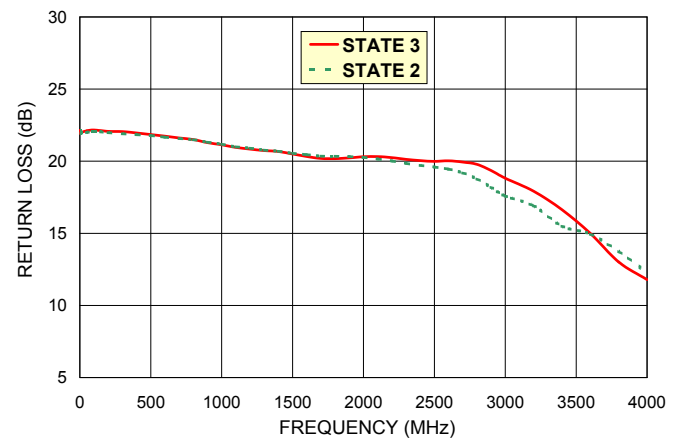

RF1 RETURN LOSS Vs. FREQUENCY

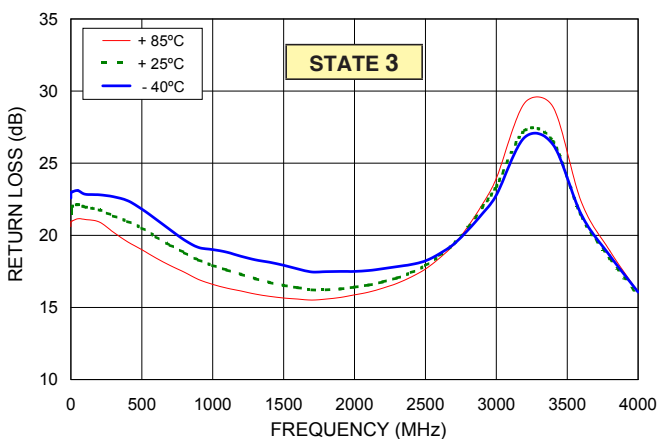

RF COM RETURN LOSS Vs. FREQUENCY

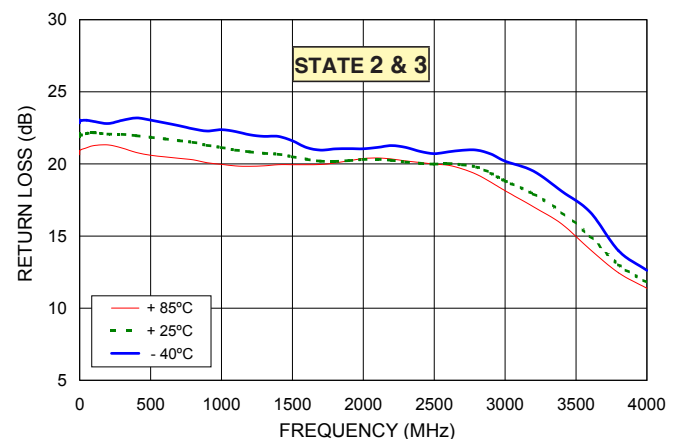

### Notes

- A. Performance and quality attributes and conditions not expressly stated in this specification document are intended to be excluded and do not form a part of this specification document.
- B. Electrical specifications and performance data contained in this specification document are based on Mini-Circuit's applicable established test performance criteria and measurement instructions.
- C. The parts covered by this specification document are subject to Mini-Circuits standard limited warranty and terms and conditions (collectively, "Standard Terms"); Purchasers of this part are entitled to the rights and benefits contained therein. For a full statement of the Standard Terms and the exclusive rights and remedies thereunder, please visit Mini-Circuits' website at [www.minicircuits.com/MCLStore/terms.jsp](http://www.minicircuits.com/MCLStore/terms.jsp)

Typical Performance Curves over various states. For switch state see Truth Table 1 on page 3.

RF1 RETURN LOSS Vs. FREQUENCY

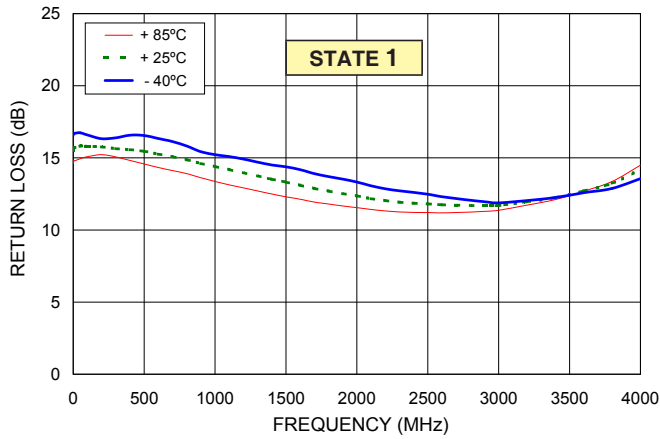

RF COM RETURN LOSS Vs. FREQUENCY

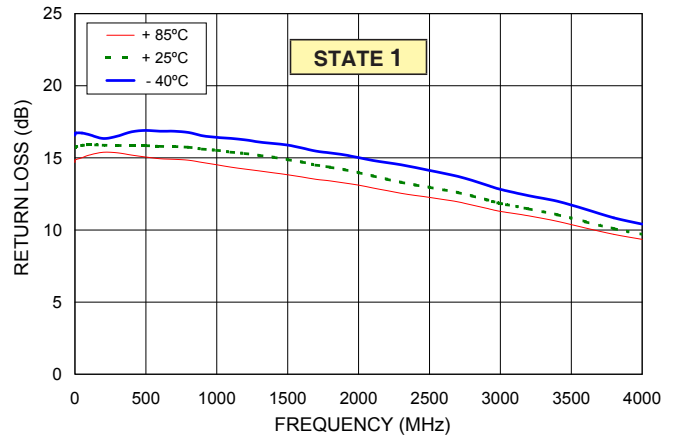

RF2 RETURN LOSS Vs. FREQUENCY

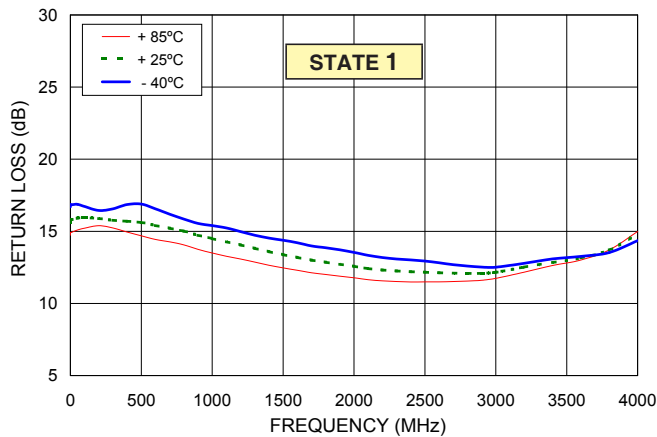

RF2 RETURN LOSS Vs. FREQUENCY

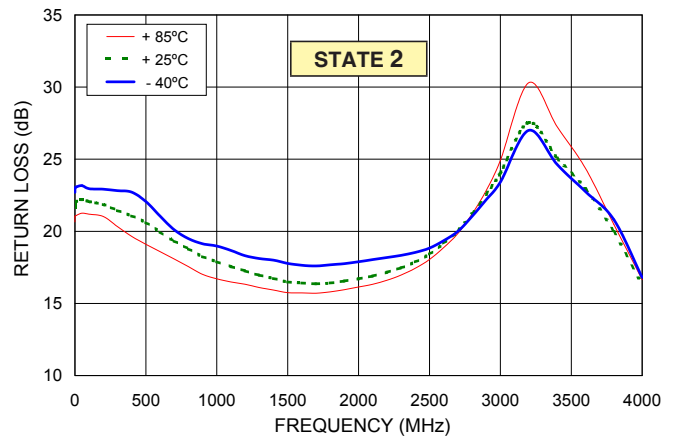

INPUT IP3 Vs. FREQUENCY

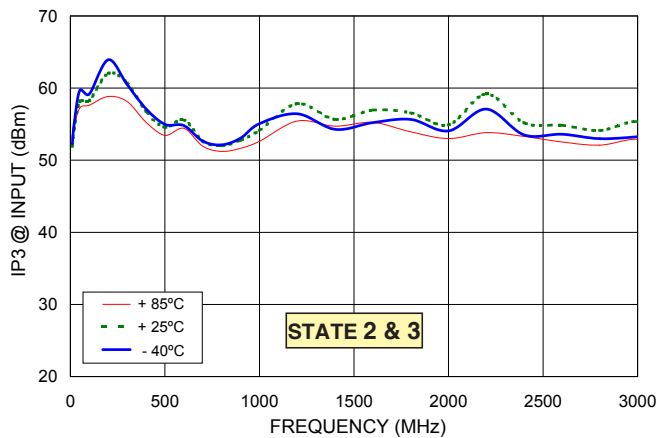

POWER IN @ 1dB COMPRESSION Vs. FREQUENCY

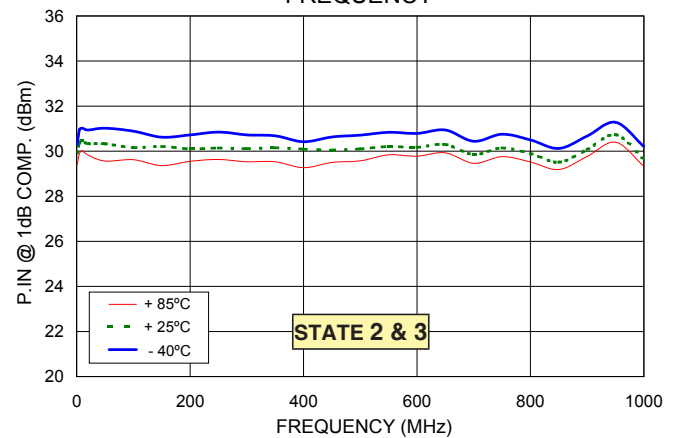

**Notes**

- A. Performance and quality attributes and conditions not expressly stated in this specification document are intended to be excluded and do not form a part of this specification document.
- B. Electrical specifications and performance data contained in this specification document are based on Mini-Circuit's applicable established test performance criteria and measurement instructions.
- C. The parts covered by this specification document are subject to Mini-Circuits standard limited warranty and terms and conditions (collectively, "Standard Terms"); Purchasers of this part are entitled to the rights and benefits contained therein. For a full statement of the Standard Terms and the exclusive rights and remedies thereunder, please visit Mini-Circuits' website at [www.minicircuits.com/MCLStore/terms.jsp](http://www.minicircuits.com/MCLStore/terms.jsp)



## Outline Drawing (HL1162)

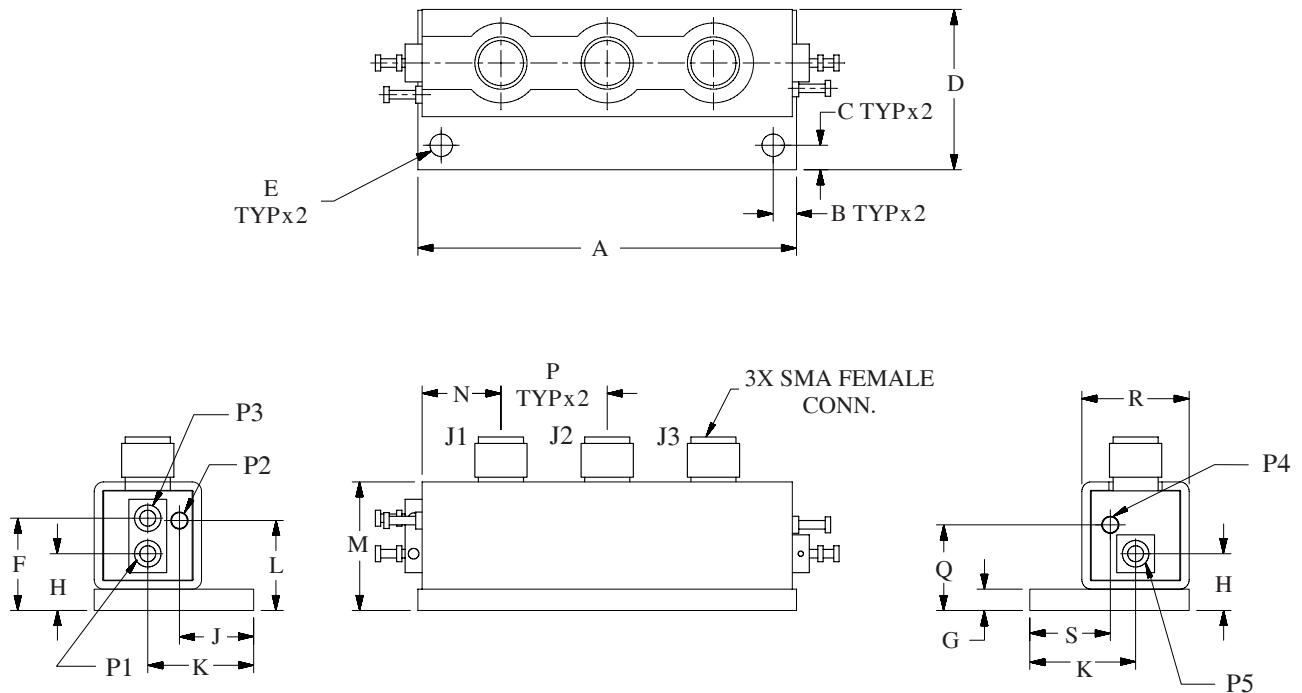

## Outline Dimensions (inch / mm)

A	B	C	D	E	F	G	H	J	K	L	M	N	P	Q	R	S	WT. GRAMS
1.780	.110	.115	.750	.106	.430	.100	.270	.350	.500	.420	.610	.370	.500	.400	.500	.380	56.0
45.21	2.79	2.92	19.05	2.69	10.92	2.54	6.86	8.89	12.70	10.67	15.49	9.39	12.70	10.16	12.70	9.65	

### Notes

- A. Performance and quality attributes and conditions not expressly stated in this specification document are intended to be excluded and do not form a part of this specification document.
- B. Electrical specifications and performance data contained in this specification document are based on Mini-Circuit's applicable established test performance criteria and measurement instructions.
- C. The parts covered by this specification document are subject to Mini-Circuits standard limited warranty and terms and conditions (collectively, "Standard Terms"); Purchasers of this part are entitled to the rights and benefits contained therein. For a full statement of the Standard Terms and the exclusive rights and remedies thereunder, please visit Mini-Circuits' website at [www.minicircuits.com/MCLStore/terms.jsp](http://www.minicircuits.com/MCLStore/terms.jsp)

## Typical Performance Data

FREQ (MHz)	INSERTION LOSS @ Vdd=+3V OVER TEMPERATURE						FREQ (MHz)	ISOLATION @ Vdd=+3V OVER TEMPERATURE														
	RF COM-RF1 (dB) STATE 3*			RF COM-RF2 (dB) STATE 2*				RF COM-RF1 (dB) STATE 2*			RF COM-RF2 (dB) STATE 3*			RF1-RF2 (dB) STATE 3*			RF1-RF2 (dB) STATE 2*			RF1-RF2 (dB) STATE 1*		
	-40°C	+25°C	+85°C	-40°C	+25°C	+85°C		-40°C	+25°C	+85°C	-40°C	+25°C	+85°C	-40°C	+25°C	+85°C	-40°C	+25°C	+85°C	-40°C	+25°C	+85°C
0.03	0.61	0.68	0.80	0.61	0.69	0.78	0.03	89.73	94.01	100.85	93.46	101.47	99.91	93.00	88.02	100.88	100.32	92.21	92.62	90.14	87.58	91.27
0.10	0.61	0.68	0.78	0.60	0.68	0.76	0.10	106.25	101.43	105.63	99.29	107.24	103.32	110.07	104.50	107.04	113.47	102.37	108.68	104.08	119.07	100.94
1.00	0.60	0.67	0.76	0.59	0.67	0.75	1.00	109.64	114.25	109.23	112.10	105.73	104.43	104.60	112.14	121.37	111.33	112.84	109.36	116.24	110.61	107.42
10.00	0.60	0.68	0.77	0.59	0.67	0.76	10.00	113.35	108.84	134.49	103.90	109.75	106.29	107.86	109.10	112.58	106.46	105.94	104.85	115.81	110.37	110.14
50.00	0.62	0.71	0.80	0.62	0.70	0.79	50.00	102.32	99.37	96.65	101.37	106.77	94.03	92.39	90.95	94.49	92.31	90.63	94.88	104.92	99.71	98.63
100.00	0.64	0.72	0.81	0.63	0.71	0.79	100.00	99.69	94.35	96.18	94.02	90.73	92.32	88.66	87.66	87.46	86.19	86.60	85.85	94.36	93.16	91.40
200.00	0.65	0.73	0.82	0.64	0.73	0.81	200.00	93.61	89.60	88.36	87.69	87.52	86.64	82.62	81.77	81.66	81.30	80.38	81.51	87.19	90.04	89.44
300.00	0.65	0.75	0.85	0.64	0.74	0.83	300.00	89.53	88.29	87.34	84.28	84.66	82.54	77.91	77.55	78.19	77.05	78.19	77.96	85.15	85.50	86.12
400.00	0.66	0.77	0.89	0.65	0.76	0.87	400.00	82.90	85.26	82.96	79.98	80.46	80.05	75.67	75.73	75.79	75.23	75.41	75.28	83.89	83.86	84.05
500.00	0.68	0.80	0.92	0.67	0.79	0.90	500.00	81.78	81.21	80.94	77.50	77.67	76.37	74.07	73.81	73.98	73.45	73.58	73.95	81.29	81.51	82.63
600.00	0.69	0.82	0.95	0.68	0.81	0.93	600.00	79.22	78.85	79.08	74.77	74.31	73.68	72.55	72.43	72.83	72.05	72.07	71.98	81.19	80.26	80.70
700.00	0.70	0.84	0.98	0.70	0.83	0.95	700.00	76.12	76.18	76.35	71.70	71.79	71.78	71.28	71.15	71.59	71.21	71.18	71.26	78.83	78.72	80.51
800.00	0.72	0.86	1.00	0.72	0.85	0.98	800.00	73.76	73.58	73.70	70.03	69.92	69.57	70.45	70.85	71.12	69.81	70.37	70.47	77.54	79.16	78.74
900.00	0.73	0.88	1.02	0.72	0.86	1.00	900.00	71.26	71.17	71.07	67.73	68.01	67.65	70.03	70.49	70.41	69.43	69.49	69.94	78.13	78.49	78.43
1000.00	0.76	0.91	1.07	0.75	0.90	1.04	1000.00	69.48	69.66	69.12	65.78	65.81	65.73	69.33	69.68	69.78	68.19	68.84	68.76	77.64	77.39	77.80
1100.00	0.78	0.94	1.11	0.77	0.93	1.09	1100.00	68.21	68.35	67.87	64.16	64.10	64.04	68.75	69.07	69.28	67.83	68.24	68.57	77.80	77.32	78.78
1200.00	0.81	0.98	1.15	0.80	0.97	1.12	1200.00	66.69	66.83	66.51	62.83	62.69	62.62	68.01	68.08	68.92	67.80	68.14	68.25	77.14	77.36	77.25
1300.00	0.82	1.00	1.18	0.82	0.99	1.15	1300.00	65.76	65.65	65.16	61.74	61.69	61.66	67.11	67.00	67.35	67.46	67.33	67.91	76.91	75.76	76.76
1400.00	0.84	1.03	1.21	0.84	1.01	1.18	1400.00	64.40	64.14	63.86	61.36	61.56	61.62	65.07	65.05	65.05	66.42	66.17	66.52	75.18	74.95	74.56
1500.00	0.87	1.06	1.24	0.87	1.05	1.22	1500.00	61.59	60.71	60.46	61.42	59.62	58.91	61.63	63.31	64.96	62.47	63.48	64.99	70.83	72.79	74.47
1600.00	0.91	1.11	1.29	0.90	1.09	1.26	1600.00	59.58	59.41	59.28	56.88	56.67	56.69	66.55	67.22	67.89	66.67	66.78	67.55	76.70	77.74	79.72
1700.00	0.92	1.13	1.31	0.91	1.10	1.28	1700.00	58.48	58.28	58.08	55.68	55.47	55.49	67.12	67.35	67.58	66.88	66.67	66.66	79.33	81.15	83.63
1800.00	0.95	1.16	1.34	0.93	1.13	1.31	1800.00	57.32	57.15	56.97	54.60	54.42	54.26	66.34	66.15	65.97	66.65	65.81	65.40	82.17	83.90	81.35
1900.00	0.94	1.15	1.34	0.93	1.13	1.31	1900.00	56.04	55.88	55.57	53.48	53.36	53.16	65.79	65.23	64.69	65.79	64.47	63.78	86.88	83.49	80.56
2000.00	0.96	1.17	1.36	0.94	1.15	1.32	2000.00	54.88	54.64	54.35	52.41	52.26	52.13	64.38	63.66	63.25	64.16	62.71	61.91	83.60	80.23	78.75
2100.00	0.95	1.17	1.36	0.94	1.14	1.32	2100.00	53.64	53.31	53.07	51.34	51.15	51.07	62.96	61.91	61.44	62.44	60.79	60.29	79.76	77.12	74.85
2200.00	0.97	1.19	1.37	0.95	1.16	1.34	2200.00	52.37	52.10	51.80	50.31	50.10	49.98	61.27	60.19	59.52	60.35	58.86	58.25	74.76	73.74	72.04
2300.00	0.96	1.18	1.37	0.95	1.16	1.34	2300.00	51.17	50.90	50.63	49.28	49.11	48.97	59.53	58.44	57.69	58.27	57.01	56.35	71.07	70.28	68.84
2400.00	0.97	1.20	1.40	0.96	1.17	1.36	2400.00	50.07	49.63	49.43	48.31	48.08	47.96	57.80	56.76	56.11	56.13	55.08	54.43	68.09	67.22	66.60
2500.00	0.96	1.19	1.39	0.95	1.17	1.36	2500.00	48.82	48.46	48.21	47.26	47.07	46.86	55.89	55.01	54.26	53.98	52.89	52.33	65.29	64.56	63.97
2600.00	0.98	1.21	1.42	0.97	1.19	1.38	2600.00	47.66	47.25	46.93	46.16	45.95	45.77	54.01	53.03	52.45	51.67	50.68	50.19	62.69	61.95	61.37
2700.00	1.00	1.24	1.45	0.98	1.21	1.42	2700.00	46.58	46.14	45.97	44.95	44.73	44.56	51.94	50.98	50.54	49.00	48.24	47.90	59.78	59.23	58.82
2800.00	1.05	1.30	1.52	1.04	1.27	1.48	2800.00	45.88	45.41	45.02	43.72	43.52	43.38	49.69	48.93	48.40	46.55	45.91	45.66	57.35	56.84	56.44
2900.00	1.08	1.34	1.57	1.07	1.31	1.52	2900.00	45.19	44.89	44.35	42.63	42.35	42.23	47.69	46.98	46.45	44.84	44.31	43.96	55.28	54.83	54.24
3000.00	1.11	1.38	1.61	1.11	1.36	1.59	3000.00	43.67	43.27	43.02	41.18	41.07	40.98	45.48	44.91	44.62	43.31	42.77	42.54	52.78	52.28	51.85

\*Note:

STATE	CONTROL INPUT		RF Com to RF1	RF Com to RF2
	Control 1	Control 2		
1	Low	Low	OFF	OFF
2	Low	High	OFF	ON
3	High	Low	ON	OFF



Typical Performance Data

FREQ (MHZ)	VSWR @ Vdd=+3V OVER TEMPERATURE																												
	RF COM (-1)			RF COM (-1)			RF1 (-1)			RF1 (-1)			RF2 (-1)			RF2 (-1)			RF COM (-1)			RF1 (-1)			RF2 (-1)				
	STATE 3*			STATE 2*			STATE 3*			STATE 2*			STATE 3*			STATE 2*			STATE 1*			STATE 1*			STATE 1*				
	-40°C	+25°C	+85°C	-40°C	+25°C	+85°C	-40°C	+25°C	+85°C	-40°C	+25°C	+85°C	-40°C	+25°C	+85°C	-40°C	+25°C	+85°C	-40°C	+25°C	+85°C	-40°C	+25°C	+85°C	-40°C	+25°C	+85°C	-40°C	+25°C
0.03	1.16	1.17	1.21	1.16	1.17	1.21	1.16	1.18	1.21	1.35	1.40	1.46	1.34	1.40	1.45	1.16	1.18	1.20	1.35	1.39	1.45	1.35	1.40	1.46	1.34	1.40	1.45		
0.10	1.15	1.17	1.20	1.15	1.17	1.20	1.15	1.17	1.20	1.34	1.39	1.45	1.34	1.39	1.44	1.15	1.17	1.20	1.34	1.39	1.45	1.34	1.39	1.45	1.34	1.39	1.44		
1.00	1.15	1.17	1.20	1.15	1.17	1.20	1.15	1.17	1.20	1.34	1.39	1.45	1.34	1.39	1.44	1.15	1.17	1.19	1.34	1.39	1.44	1.34	1.39	1.45	1.34	1.39	1.44		
10.00	1.15	1.17	1.20	1.15	1.17	1.20	1.15	1.17	1.20	1.34	1.39	1.44	1.34	1.39	1.44	1.15	1.17	1.19	1.34	1.39	1.44	1.34	1.39	1.44	1.34	1.39	1.44		
50.00	1.15	1.17	1.19	1.16	1.17	1.20	1.15	1.17	1.19	1.34	1.39	1.44	1.34	1.38	1.43	1.15	1.17	1.19	1.34	1.38	1.43	1.34	1.39	1.44	1.33	1.38	1.43		
100.00	1.15	1.17	1.19	1.16	1.17	1.19	1.16	1.17	1.19	1.35	1.39	1.43	1.34	1.38	1.42	1.15	1.17	1.19	1.35	1.38	1.42	1.35	1.39	1.43	1.34	1.38	1.42		
200.00	1.16	1.17	1.19	1.17	1.17	1.18	1.16	1.18	1.20	1.36	1.39	1.42	1.35	1.38	1.41	1.15	1.18	1.19	1.36	1.38	1.41	1.36	1.39	1.42	1.35	1.38	1.41		
300.00	1.15	1.17	1.19	1.16	1.17	1.18	1.16	1.19	1.22	1.36	1.40	1.43	1.35	1.39	1.42	1.16	1.19	1.21	1.35	1.38	1.41	1.36	1.40	1.43	1.35	1.39	1.42		
400.00	1.15	1.17	1.20	1.15	1.18	1.20	1.16	1.20	1.24	1.35	1.40	1.44	1.34	1.39	1.43	1.16	1.19	1.23	1.34	1.38	1.42	1.35	1.40	1.44	1.34	1.39	1.44		
500.00	1.15	1.18	1.21	1.15	1.18	1.20	1.18	1.21	1.25	1.35	1.41	1.46	1.34	1.40	1.45	1.17	1.21	1.25	1.33	1.38	1.43	1.35	1.41	1.46	1.33	1.40	1.45		
600.00	1.16	1.18	1.21	1.15	1.18	1.21	1.19	1.23	1.27	1.36	1.42	1.48	1.35	1.41	1.47	1.19	1.22	1.27	1.34	1.39	1.44	1.36	1.42	1.48	1.35	1.41	1.47		
700.00	1.16	1.18	1.21	1.16	1.18	1.21	1.21	1.24	1.29	1.37	1.43	1.49	1.37	1.42	1.48	1.22	1.24	1.29	1.34	1.39	1.44	1.37	1.43	1.49	1.37	1.42	1.48		
800.00	1.16	1.18	1.21	1.16	1.18	1.21	1.23	1.26	1.31	1.39	1.44	1.51	1.39	1.43	1.49	1.24	1.26	1.31	1.34	1.39	1.44	1.39	1.44	1.51	1.38	1.43	1.49		
900.00	1.17	1.19	1.22	1.17	1.19	1.22	1.25	1.28	1.33	1.41	1.46	1.53	1.40	1.45	1.51	1.25	1.28	1.33	1.35	1.40	1.45	1.41	1.46	1.53	1.40	1.45	1.52		
1000.00	1.16	1.19	1.22	1.17	1.19	1.22	1.25	1.29	1.35	1.42	1.47	1.55	1.41	1.46	1.53	1.25	1.29	1.34	1.36	1.40	1.46	1.42	1.47	1.55	1.41	1.46	1.54		
1100.00	1.17	1.20	1.23	1.17	1.20	1.23	1.26	1.30	1.36	1.43	1.49	1.57	1.42	1.48	1.55	1.26	1.31	1.35	1.36	1.41	1.47	1.43	1.49	1.57	1.42	1.48	1.55		
1200.00	1.17	1.20	1.23	1.18	1.20	1.23	1.27	1.32	1.37	1.44	1.50	1.58	1.44	1.49	1.57	1.28	1.32	1.36	1.36	1.41	1.48	1.44	1.50	1.58	1.43	1.49	1.57		
1300.00	1.17	1.20	1.23	1.18	1.20	1.23	1.28	1.33	1.38	1.45	1.52	1.60	1.45	1.51	1.59	1.28	1.33	1.37	1.37	1.42	1.49	1.45	1.52	1.60	1.45	1.51	1.59		
1400.00	1.17	1.20	1.22	1.18	1.20	1.23	1.28	1.34	1.39	1.46	1.53	1.62	1.46	1.53	1.61	1.29	1.34	1.38	1.38	1.43	1.50	1.46	1.53	1.62	1.46	1.53	1.61		
1500.00	1.18	1.21	1.22	1.18	1.21	1.23	1.29	1.35	1.40	1.47	1.55	1.64	1.47	1.55	1.62	1.30	1.35	1.39	1.38	1.44	1.51	1.47	1.55	1.64	1.47	1.55	1.62		
1600.00	1.19	1.21	1.22	1.19	1.21	1.23	1.30	1.36	1.40	1.48	1.57	1.66	1.49	1.56	1.64	1.30	1.36	1.39	1.39	1.45	1.52	1.49	1.57	1.66	1.48	1.56	1.64		
1700.00	1.20	1.22	1.22	1.19	1.21	1.23	1.31	1.37	1.40	1.50	1.59	1.68	1.50	1.58	1.66	1.30	1.36	1.39	1.41	1.46	1.54	1.51	1.59	1.68	1.50	1.58	1.66		
1800.00	1.19	1.22	1.22	1.19	1.21	1.22	1.31	1.37	1.40	1.52	1.60	1.69	1.51	1.59	1.67	1.30	1.36	1.39	1.41	1.47	1.54	1.52	1.60	1.69	1.51	1.59	1.67		
1900.00	1.19	1.22	1.22	1.19	1.21	1.22	1.31	1.36	1.39	1.53	1.62	1.71	1.52	1.60	1.68	1.30	1.35	1.38	1.42	1.49	1.56	1.53	1.62	1.71	1.52	1.60	1.68		
2000.00	1.19	1.21	1.21	1.19	1.21	1.22	1.31	1.36	1.38	1.55	1.64	1.72	1.53	1.62	1.69	1.29	1.34	1.37	1.43	1.50	1.57	1.55	1.64	1.72	1.53	1.61	1.69		
2100.00	1.19	1.21	1.21	1.19	1.22	1.22	1.31	1.35	1.37	1.57	1.65	1.74	1.55	1.63	1.71	1.29	1.33	1.36	1.44	1.52	1.58	1.57	1.65	1.73	1.55	1.63	1.71		
2200.00	1.19	1.22	1.21	1.19	1.22	1.23	1.30	1.34	1.36	1.59	1.67	1.75	1.56	1.64	1.71	1.28	1.32	1.35	1.45	1.53	1.60	1.59	1.67	1.75	1.56	1.64	1.72		
2300.00	1.19	1.22	1.22	1.19	1.23	1.23	1.29	1.33	1.34	1.60	1.68	1.75	1.57	1.65	1.72	1.28	1.31	1.33	1.46	1.55	1.62	1.60	1.68	1.75	1.57	1.65	1.72		
2400.00	1.20	1.22	1.22	1.20	1.23	1.24	1.29	1.31	1.32	1.61	1.69	1.76	1.58	1.65	1.72	1.27	1.29	1.31	1.48	1.57	1.63	1.61	1.69	1.76	1.58	1.65	1.73		
2500.00	1.20	1.22	1.22	1.21	1.23	1.24	1.28	1.29	1.30	1.62	1.69	1.76	1.58	1.65	1.72	1.26	1.27	1.29	1.49	1.58	1.64	1.62	1.69	1.76	1.58	1.65	1.73		
2600.00	1.20	1.22	1.22	1.21	1.24	1.25	1.26	1.27	1.27	1.64	1.70	1.76	1.59	1.66	1.72	1.24	1.25	1.26	1.50	1.60	1.66	1.64	1.70	1.76	1.59	1.66	1.73		
2700.00	1.20	1.22	1.23	1.22	1.25	1.26	1.24	1.24	1.24	1.65	1.70	1.76	1.60	1.66	1.72	1.22	1.22	1.23	1.52	1.61	1.68	1.65	1.70	1.76	1.60	1.66	1.72		
2800.00	1.20	1.23	1.24	1.23	1.26	1.28	1.21	1.21	1.21	1.66	1.70	1.76	1.61	1.66	1.72	1.19	1.19	1.19	1.54	1.64	1.70	1.66	1.70	1.76	1.61	1.66	1.72		
2900.00	1.20	1.24	1.26	1.25	1.28	1.30	1.18	1.17	1.17	1.67	1.70	1.75	1.62	1.66	1.71	1.17	1.16	1.16	1.57	1.66	1.72	1.68	1.70	1.75	1.62	1.66	1.71		
3000.00	1.22	1.26	1.28	1.28	1.30	1.32	1.16	1.15	1.14	1.68	1.70	1.74	1.62	1.65	1.70	1.14	1.13	1.12	1.59	1.69	1.75	1.68	1.70	1.74	1.62	1.65	1.70		

\*Note:

STATE	CONTROL INPUT		RF Com to RF1	RF Com to RF2
	Control 1	Control 2		
1	Low	Low	OFF	OFF
2	Low	High	OFF	ON
3	High	Low	ON	OFF

## Typical Performance Data

FREQ (MHz)	INPUT IP3 @ Vdd=+3V OVER TEMPERATURE						FREQ (MHz)	INPUT 1dB COMPRESSION @ Vdd=+3V OVER TEMPERATURE					
	RF COM-RF1 (dBm)			RF COM-RF2 (dBm)				RF COM-RF1 (dBm)			RF COM-RF2 (dBm)		
	STATE 3*			STATE 2*				STATE 3*			STATE 2*		
	-40°C	+25°C	+85°C	-40°C	+25°C	+85°C		-40°C	+25°C	+85°C	-40°C	+25°C	+85°C
10.00	52.29	51.92	51.86	51.85	52.10	51.27	1.00	30.30	29.92	29.41	30.29	29.89	29.40
20.00	55.02	54.32	54.44	54.43	54.68	53.27	5.00	30.96	30.36	29.90	30.96	30.32	29.87
50.00	59.68	58.12	57.24	59.05	57.55	57.90	10.00	31.02	30.48	30.02	31.02	30.46	29.96
100.00	59.17	58.26	57.62	59.60	58.53	57.76	20.00	30.94	30.33	29.83	30.91	30.27	29.79
200.00	63.93	62.03	58.83	63.47	61.55	58.94	50.00	31.02	30.33	29.56	31.00	30.17	29.80
300.00	60.49	60.70	58.12	60.94	60.23	58.08	100.00	30.89	30.16	29.62	30.85	30.12	29.61
400.00	57.13	56.77	55.27	57.49	56.87	55.26	150.00	30.62	30.21	29.36	30.66	29.80	29.40
500.00	54.98	54.58	53.45	55.09	54.51	53.32	200.00	30.72	30.10	29.55	30.70	30.02	29.62
600.00	54.80	55.61	54.42	54.94	55.81	54.25	250.00	30.85	30.14	29.63	30.85	29.98	29.62
700.00	52.66	52.64	51.94	52.69	52.68	51.87	300.00	30.72	30.11	29.53	30.69	29.88	29.53
800.00	52.13	52.01	51.22	52.15	51.98	51.20	350.00	30.68	30.15	29.53	30.66	30.02	29.61
900.00	53.05	52.76	51.65	53.06	52.58	51.58	400.00	30.42	30.09	29.27	30.44	29.70	29.62
1000.00	55.07	54.15	52.62	54.91	54.18	52.53	450.00	30.63	30.05	29.50	30.58	29.83	29.53
1200.00	56.44	57.85	55.43	56.67	58.23	55.28	500.00	30.71	30.10	29.57	30.69	29.88	29.61
1400.00	54.28	55.67	54.72	54.25	55.93	54.79	550.00	30.84	30.21	29.84	30.87	30.27	29.81
1600.00	55.21	56.94	55.24	55.39	57.32	55.03	600.00	30.79	30.17	29.78	30.81	30.20	29.75
1800.00	55.65	56.57	53.93	55.83	56.49	53.71	650.00	30.94	30.30	29.93	30.96	30.36	29.91
2000.00	54.06	54.90	53.00	53.98	54.79	52.91	700.00	30.44	29.85	29.46	30.48	29.87	29.43
2200.00	57.08	59.19	53.82	55.97	56.90	53.97	750.00	30.75	30.14	29.76	30.77	30.21	29.75
2400.00	53.50	55.18	53.30	53.68	55.65	53.29	800.00	30.50	29.89	29.52	30.51	29.92	29.51
2600.00	53.60	54.85	52.53	53.99	54.96	52.42	850.00	30.12	29.51	29.19	30.15	29.57	29.16
2800.00	52.99	54.12	52.09	53.18	54.08	52.02	900.00	30.67	30.07	29.77	30.71	30.15	29.78
3000.00	53.25	55.36	52.90	53.44	55.92	52.82	950.00	31.28	30.73	30.40	31.34	30.78	30.39
							1000.00	30.21	29.65	29.33	30.28	29.71	29.33

\*Note:

STATE	CONTROL INPUT		RF Com to RF1	RF Com to RF2
	Control 1	Control 2		
1	Low	Low	OFF	OFF
2	Low	High	OFF	ON
3	High	Low	ON	OFF

## Typical Performance Curves

**Insertion Loss @ Vdd=+3V over Temperature**  
RF COM-RF1 (State 3\*) & RF COM RF2 (State 2\*)

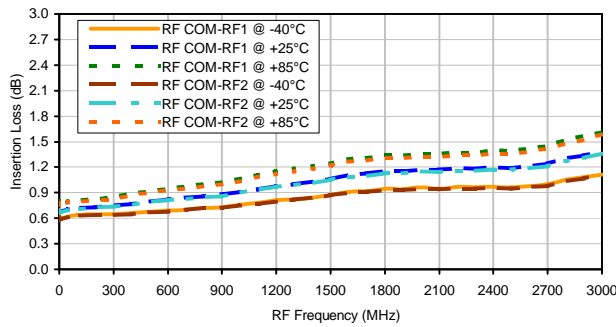

**Isolation @ Vdd=+3V over Temperature**  
RF COM-RF1 (State 2\*) & RF COM RF2 (State 3\*)

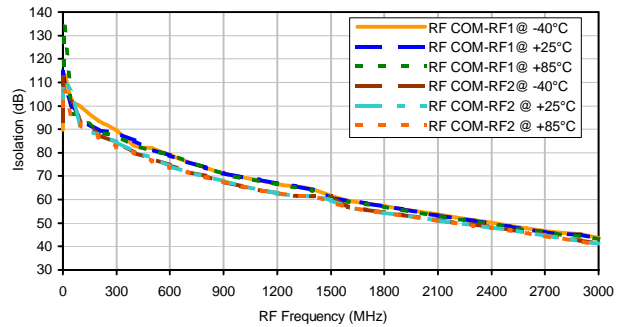

**Isolation @ Vdd=+3V over Temperature**  
RF1-RF2 (State 1\*)

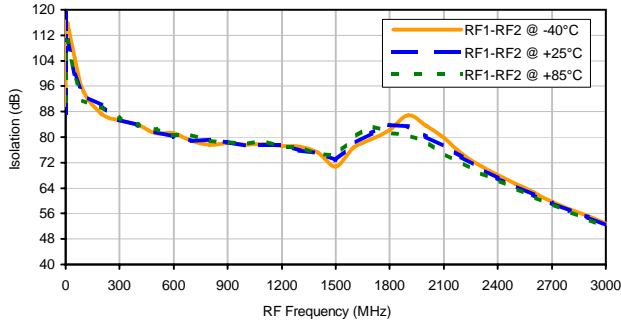

**Isolation @ Vdd=+3V over Temperature**  
RF1-RF2 (State 2\*)

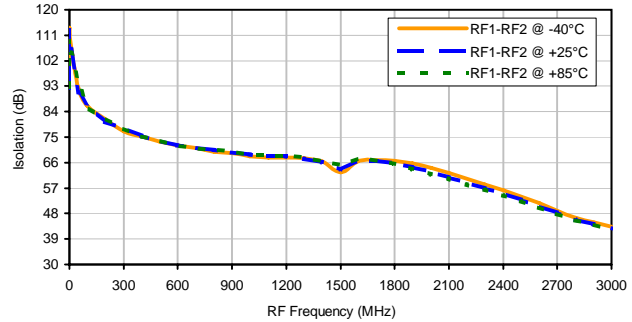

**Isolation @ Vdd=+3V over Temperature**  
RF1-RF2 (State 3\*)

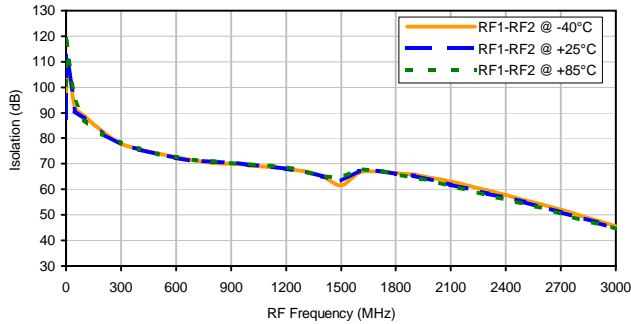

**VSWR @ Vdd=+3V over Temperature**  
RF COM (State 1\*)

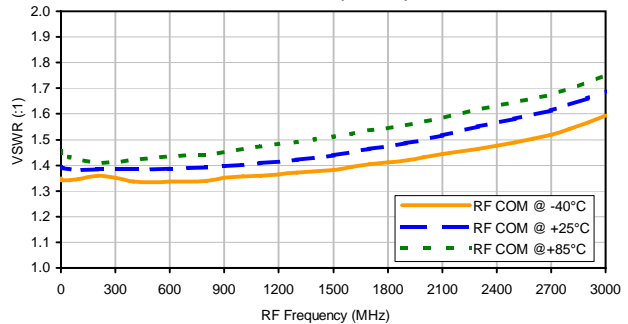

**VSWR @ Vdd=+3V over Temperature**  
RF COM (State 2\*)

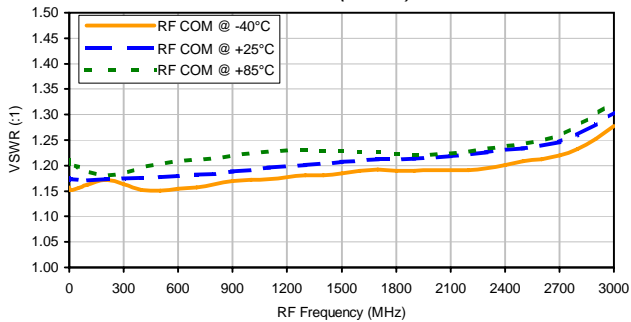

**VSWR @ Vdd=+3V over Temperature**  
RF COM (State 3\*)

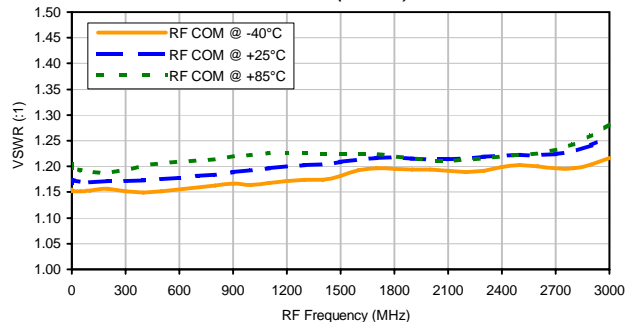

**\*Note:**

STATE	CONTROL INPUT		RF Com to RF1	RF Com to RF2
	Control 1	Control 2		
1	Low	Low	OFF	OFF
2	Low	High	OFF	ON
3	High	Low	ON	OFF

## Typical Performance Curves

**VSWR @ Vdd=+3V over Temperature**  
RF1 (State 1\*)

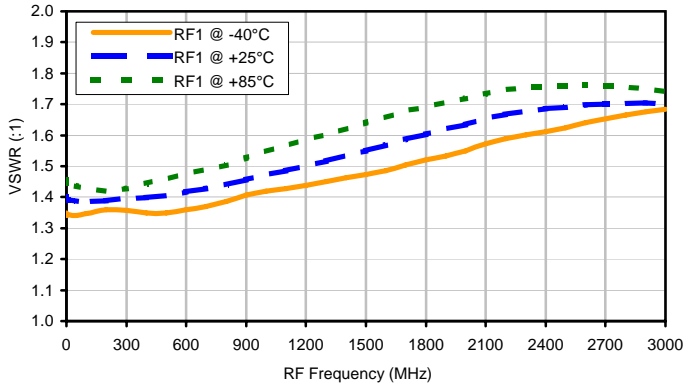

**VSWR @ Vdd=+3V over Temperature**  
RF1 (State 2\*)

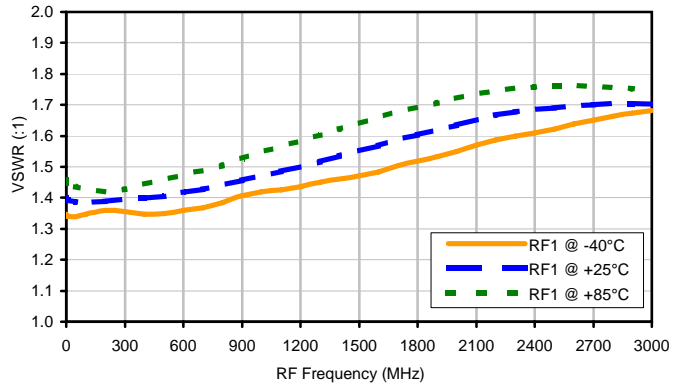

**VSWR @ Vdd=+3V over Temperature**  
RF1 (State 3\*)

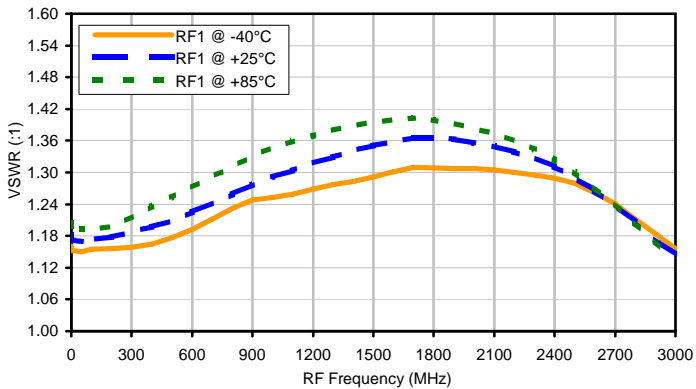

**VSWR @ Vdd=+3V over Temperature**  
RF2 (State 1\*)

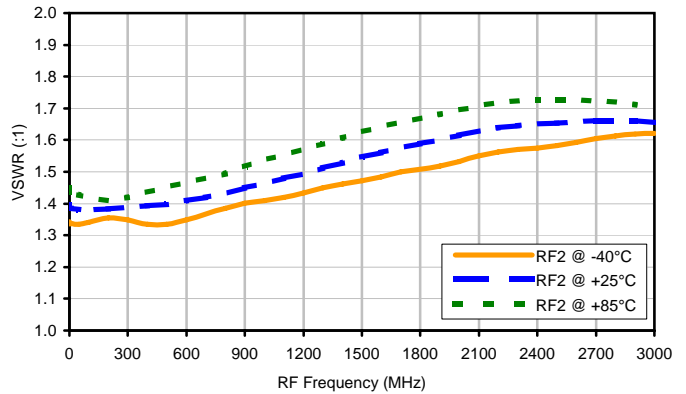

**VSWR @ Vdd=+3V over Temperature**  
RF2 (State 2\*)

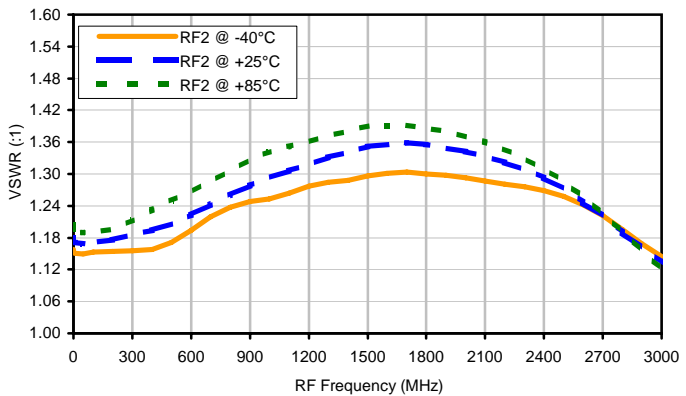

**VSWR @ Vdd=+3V over Temperature**  
RF2 (State 3\*)

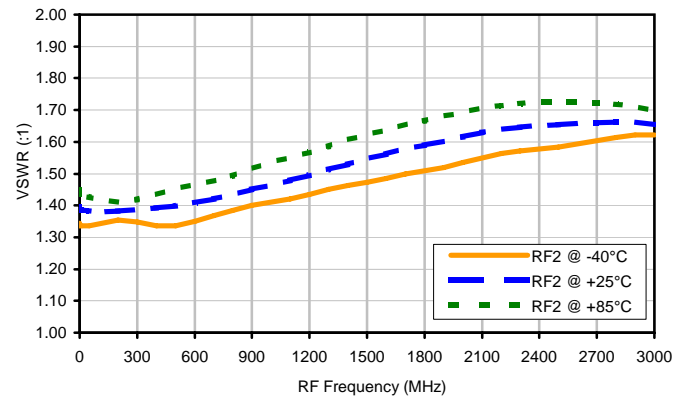

\*Note:

STATE	CONTROL INPUT		RF Com to RF1	RF Com to RF2
	Control 1	Control 2		
1	Low	Low	OFF	OFF
2	Low	High	OFF	ON
3	High	Low	ON	OFF

## Typical Performance Curves

Input IP3 @ Vdd=+3V over Temperature  
RF COM-RF1 (State 3\*)

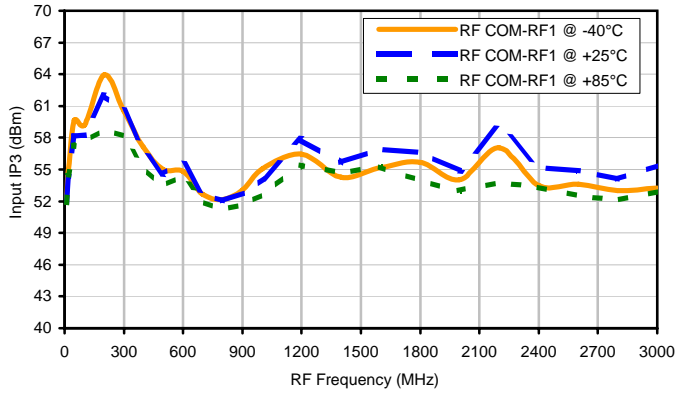

Input IP3 @ Vdd=+3V over Temperature  
RF COM -RF2 (State 2\*)

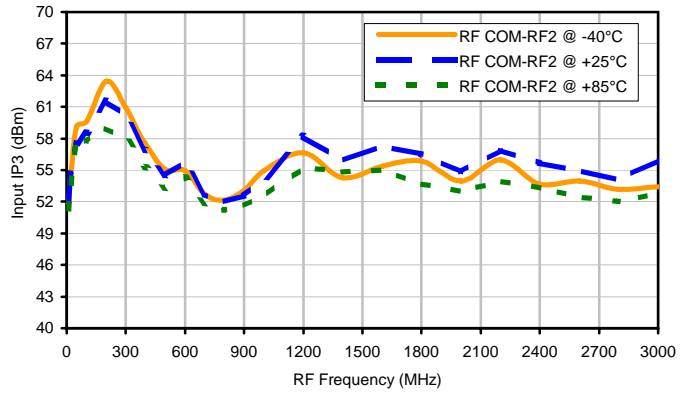

Input 1dB Compression @ Vdd=+3V over Temperature  
RF COM-RF1 (State 3\*)

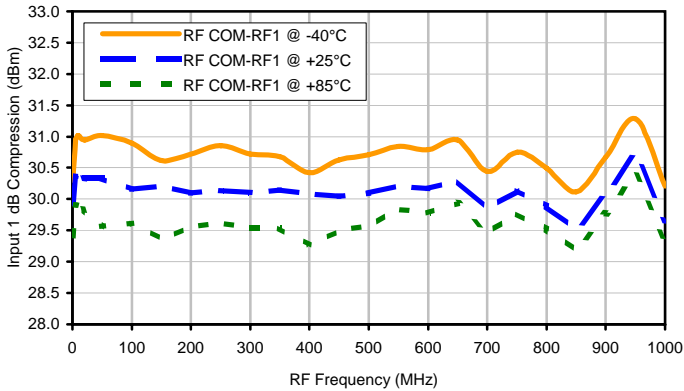

Input 1dB Compression @ Vdd=+3V over Temperature  
RF COM-RF2 (State 2\*)

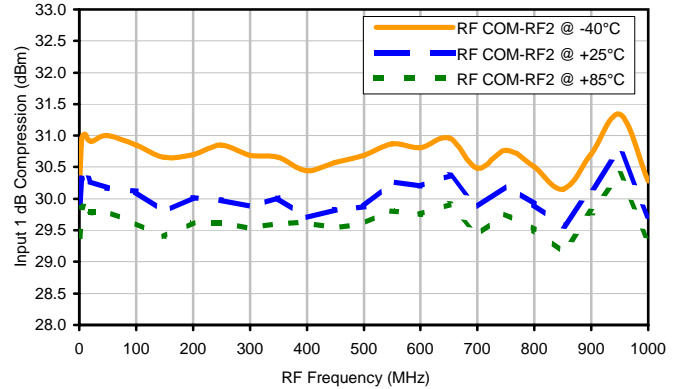

\*Note:

STATE	CONTROL INPUT		RF Com to RF1	RF Com to RF2
	Control 1	Control 2		
1	Low	Low	OFF	OFF
2	Low	High	OFF	ON
3	High	Low	ON	OFF

# Case Style

# HL

## Outline Dimensions

## HL1162

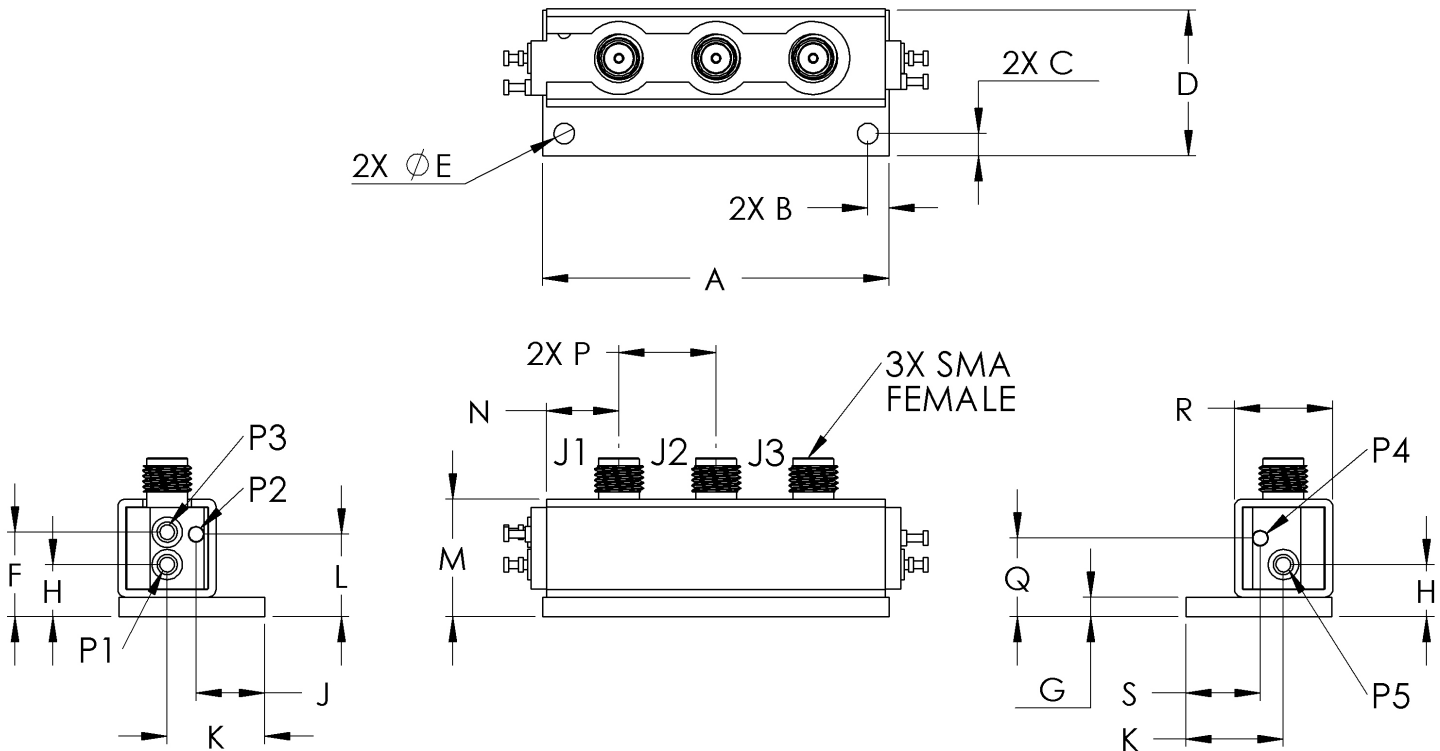

CASE #.	A	B	C	D	E	F	G	H	J	K	L	M	N
HL1162	1.782 (45.26)	.110 (2.79)	.115 (2.92)	.750 (19.05)	.106 (2.69)	.435 (11.04)	.100 (2.54)	.268 (6.79)	.353 (8.97)	.502 (12.75)	.424 (10.76)	.605 (15.37)	.371 (9.42)

CASE #.	P	Q	R	S	WT GRAMS
HL1162	.500 (12.70)	.404 (10.25)	.505 (12.83)	.383 (9.73)	56

**Dimensions are in inches (mm). Tolerances: 2Pl. ± .03; 3Pl. ± .015**  
**Tolerance on hole size and interaxes dimensions to be ± .005.**

### Note:

1. Case material: Brass
2. Case finish: Nickel plate

**Mini-Circuits®**

Distribution Centers NORTH AMERICA 800-654-7949 • 417-335-5935 • Fax 417-335-5945 • EUROPE 44-1252-832600 • Fax 44-1252-837010

Mini-Circuits ISO 9001 & ISO 14001 Certified

INTERNET <http://www.minicircuits.com>

P.O. Box 350166, Brooklyn, New York 11235-0003 (718) 934-4500 Fax (718) 332-4661



All Mini-Circuits products are manufactured under exacting quality assurance and control standards, and are capable of meeting published specifications after being subjected to any or all of the following physical and environmental test.

Specification	Test/Inspection Condition	Reference/Spec
Operating Temperature	-40° to 85°C	Individual Model Data Sheet
Storage Temperature	-55° to 100° C Ambient Environment	Individual Model Data Sheet
Barometric Pressure	100,000 Feet	MIL-STD-202, Method 105, Condition D
Humidity	90% RH, 65°C Units may require bake-out after humidity to restore full performance.	MIL-STD-202, Method 103
Thermal Shock	-65° to 125°C, 5 cycles	MIL-STD-202, Method 107, Condition B
Vibration (High Frequency)	20g peak, 10-2000 Hz, 12 times in each of three perpendicular directions (total 36)	MIL-STD-202, Method 204, Condition D
Mechanical Shock	100g, 6ms sawtooth, 3 shocks each direction 3 axes (total 18)	MIL-STD-202, Method 213, Condition I