

2 Way 0° Power Divider 40-1000MHz

MACPES0045
V2

Features

- Surface Mount
- 2 Way 0 degree
- Available on tape & reel
- Excellent isolation

Description

M/A-COM's MACPES0045 is 2 way 0 degree power divider in a low cost, surface mount package. Ideally suited for high volume CATV & VSAT applications. Two 0603 1pf capacitors and one 160 Ohm resistor are required with this part.



Pin Configuration

Pin No.	Function
1	Output 1
3	Ground
4	Input
2&5	2 x External shunt 1pf Cap, short pin 2 & 5 together.
6	Output 2

Schematic

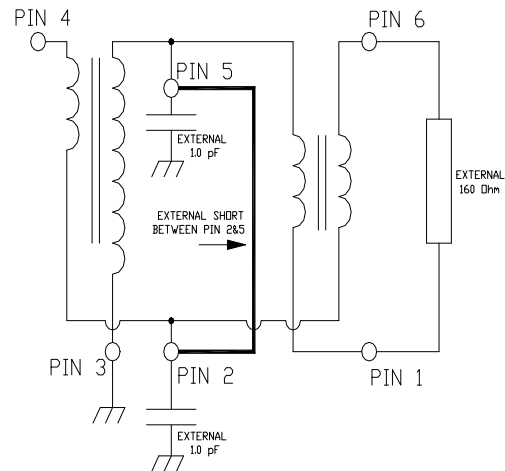

Case Style: SM-150

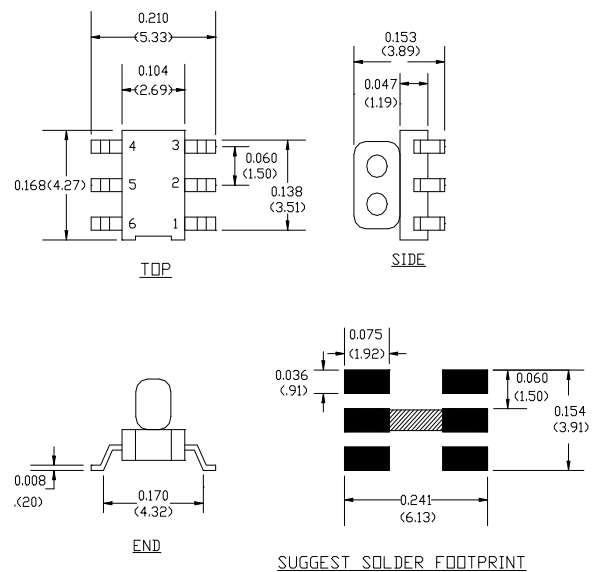

Ordering Information

Part Number	Package
MACPES0045	2000 piece reel

Dimensions in inches [mm] Tolerance: .xx ± .02, .xxx ± .010

Note: Reference Application Note **M513** for reel size information.

2 Way 0° Power Divider 40-1000MHz

MACPES0045
V2

Electrical Specifications: $T_A = 25^\circ\text{C}$, $Z_0 = 75\Omega$

Parameter	Test Conditions	Units	Min	Typ	Max
Insertion Loss (Above 3dB)	40 - 700 MHz	dB	-	0.3	0.8
	700 - 850 MHz	dB	-	0.5	1.0
	850 - 870 MHz	dB	-	0.9	1.2
	870 - 1000 MHz	dB	-	1.0	1.4
Isolation	40 - 1000 MHz	dB	18	25	-
Amplitude Unbalance	40 - 1000 MHz	dB	-	0.2	0.5
Phase Unbalance	40 - 1000 MHz	°	-	0.5°	5°
Input Return Loss	40 - 700 MHz	dB	-	25	15
	700 - 1000 MHz	dB	-	18	12
Output Return Loss 1	40 - 440 MHz	dB	-	20	15
	440 - 700 MHz	dB	-	16	12
	700 - 1000 MHz	dB	-	13	10
Output Return Loss 2	40 - 440 MHz	dB	-	16	13
	440 - 700 MHz	dB	-	18	15
	700 - 1000 MHz	dB	-	14	11

Note: Specification subject to change without notice

Absolute Maximum Ratings ^{1,2}

Parameter	Absolute Maximum
RF Power	1 Watt
Internal Load Dissipation	0.125 Watt
Storage Temperature	-40°C to +85°C
Operating Temperature	-40°C to +80°C

- Exceeding any one or combination of these limits may cause permanent damage to this device.
- M/A-COM does not recommend sustained operation near these survivability limits.

Recommended PCB Configuration

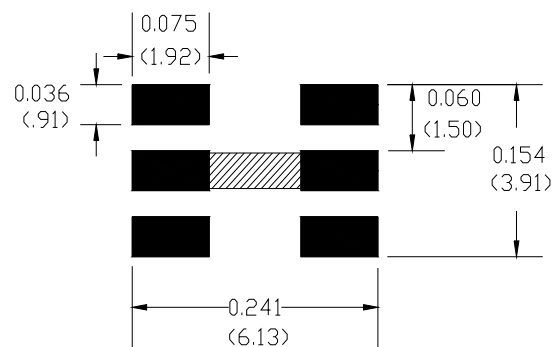

2 Way 0° Power Divider
40-1000MHz

MACPES0045
V2

Typical Performance Curves @ $T_A = 25^\circ\text{C}$, $Z_0 = 75\Omega$

Insertion Loss Port 1

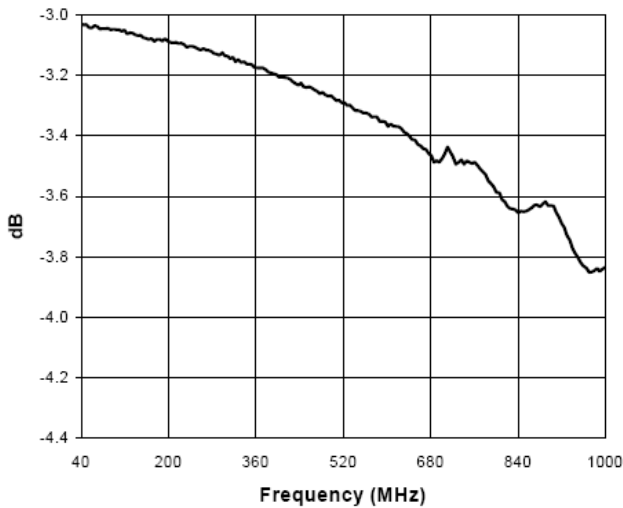

Insertion Loss Port 2

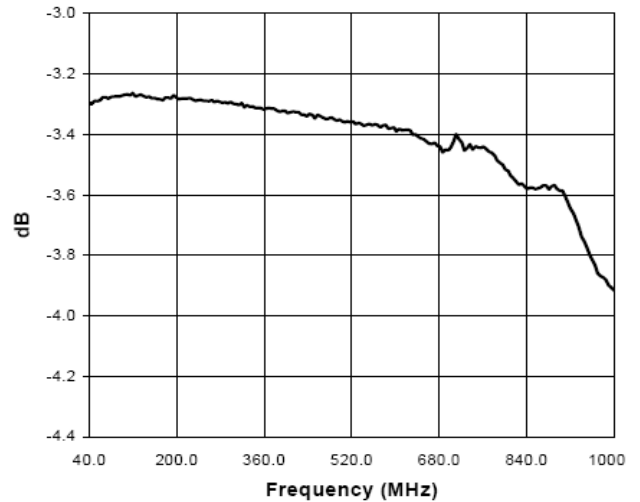

Amplitude Unbalance

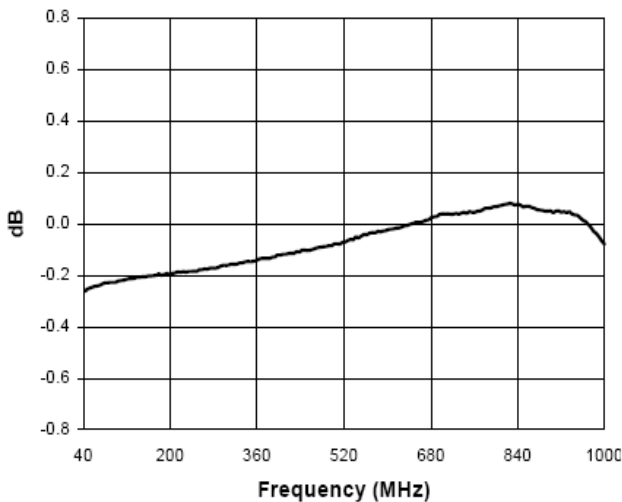

Phase Unbalance

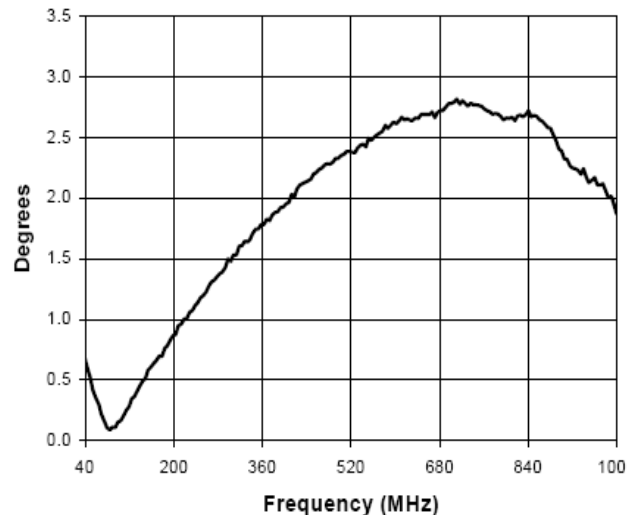

2 Way 0° Power Divider
40-1000MHz

MACPES0045
V2

Typical Performance Curves @ $T_A = 25^\circ\text{C}$, $Z_0 = 75\Omega$

Isolation

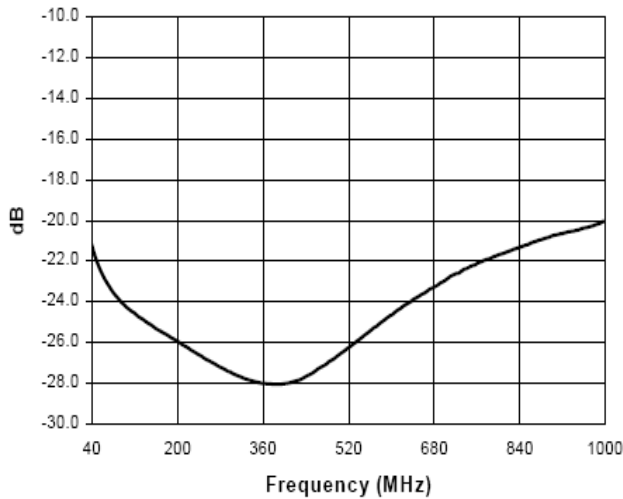

Input Return Loss

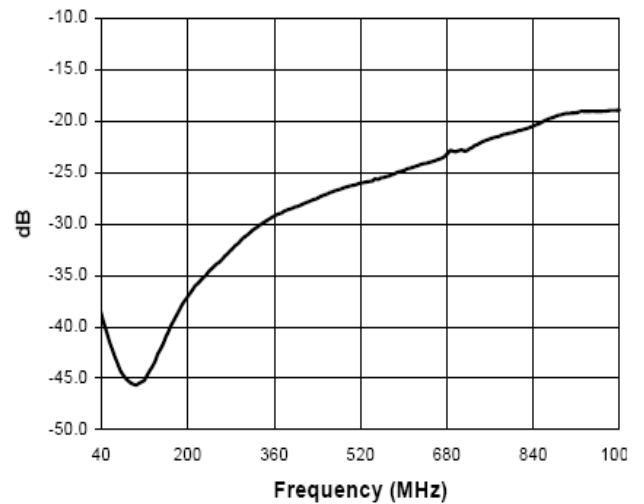

Output Return Loss 1

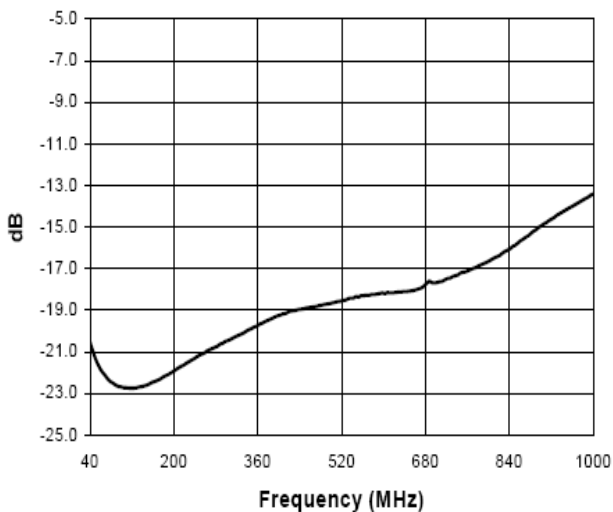

Output Return Loss 2

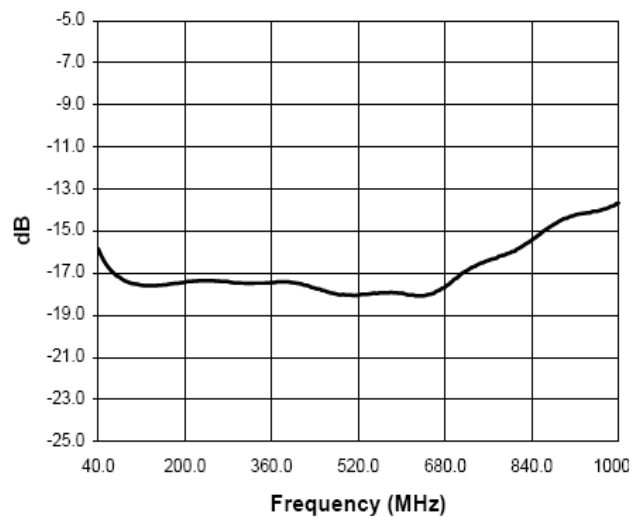

Mouser Electronics

Authorized Distributor

Click to View Pricing, Inventory, Delivery & Lifecycle Information:

[MACOM:](#)

[SW90-0001](#)