

SP05 Series - 30pF 30kV Unidirectional TVS Array

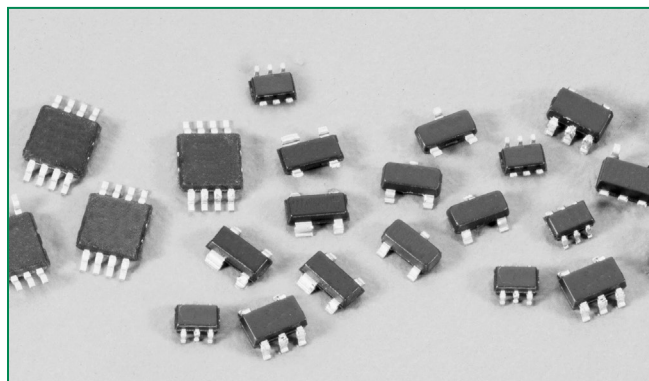

Pinout

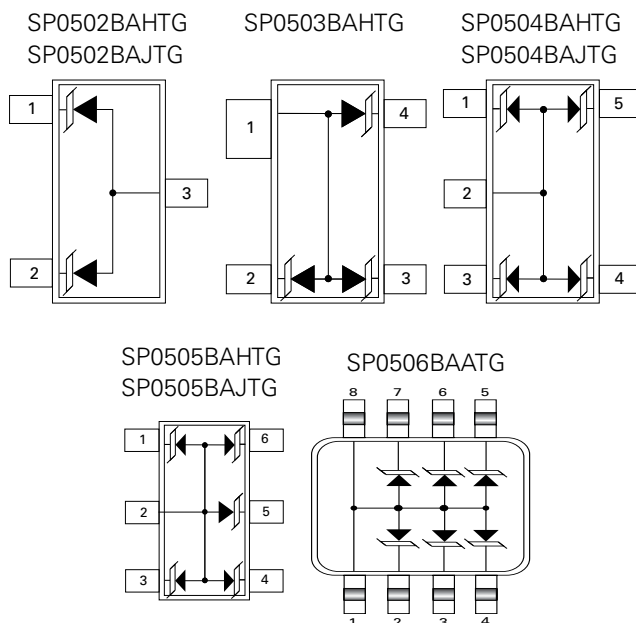

Description

This surface mount family of arrays suppress ESD and other transient overvoltage events. Used to meet the International Electrotechnical Compatibility (IEC transient immunity standards IEC 61000-4-2 for Electrostatic Discharge Requirements), these components can help protect sensitive digital or analog input circuits on data, signal, or control lines with voltage levels up to 5VDC.

The monolithic silicon arrays are comprised of specially designed structures for transient voltage suppression (TVS). The size and shape of these structures have been tailored for transient protection. Compared to MOVs, this diode array provides a lower clamping voltage and lower off-state capacitance.

Features

- An Array of 2, 3, 4, 5 or 6 TVS Avalanche Diodes in a ultra small SC70, SOT-23, SOT-143 or MSOP packages
- ESD Capability Standards
 - IEC 61000-4-2, Direct Discharge 30kV (Level 4)
 - IEC 61000-4-2, Air Discharge..... 30kV (Level 4)
 - MIL STD 883 3015.7..... 30kV
- Input Protection for Applications Up to 5VDC
- Fast Response Time <1ns
- Low Input Capacitance..... 30pF Typical
- Operating Temperature Range..... -40°C to 125°C

Applications

- Mobile phone handsets
- Personal Digital Assistants (PDA)
- Portable handheld equipment (Laptop, Palmtop computers)
- Computer port, keyboard (USB1.1)
- Digital still cameras
- Digital video cameras
- MP3 players
- Moisture Sensitivity Level (MSL-1)

Additional Information



Datasheet



Resources



Samples

Life Support Note:

Not Intended for Use in Life Support or Life Saving Applications

The products shown herein are not designed for use in life sustaining or life saving applications unless otherwise expressly indicated.

Absolute Maximum Ratings

| Symbol | Parameter | Rating | Units |
|-------------------|-----------------------|------------|-------|
| T _{OP} | Operating Temperature | -40 to 125 | °C |
| T _{STOR} | Storage Temperature | -55 to 150 | °C |

Notes:

CAUTION: Stresses above those listed in "Absolute Maximum Ratings" may cause permanent damage to the component. This is a stress only rating and operation of the component at these or any other conditions above those indicated in the operational sections of this specification is not implied.

Electrical Characteristics T_A = +25°C, Unless Otherwise Specified

| Parameter | Test Conditions | Min | Typ | Max | Units |
|------------------------------------|----------------------|------|------|------|-------|
| Reverse Standoff Voltage | I _R ≤ 1μA | - | - | 5.5 | V |
| Reverse Standoff Leakage Current | V = 5.0V | | 1 | 100 | nA |
| Signal Clamp Voltage | | | | | |
| Positive | I = 1mA | 6.0 | | 8.5 | V |
| Negative | I = 10mA | -1.2 | -0.8 | -0.4 | V |
| Clamp Voltage during ESD | | | | | |
| MIL-STD-883 Method 3015 (HBM) test | | | | | |
| + 8kV | | | 12 | | V |
| - 8kV | | | -8 | | V |
| ESD Test Level (1) | | | | | |
| IEC-61000-4-2, Contact discharge | | 30 | | | kV |
| MIL-STD-883 Method 3015 (HBM) | | 30 | | | kV |
| Capacitance | 2.5V @ 1MHz | | 30 | | pF |
| Turn on/off Time | | | <1 | | ns |
| Diode Dynamic Resistance | | | | | |
| Forward Conduction | | | 1.0 | | Ω |
| Reverse Conduction | | | 1.4 | | Ω |

Note:

(1) ESD voltage applied between channel pins and ground, one pin at a time; all other channel pins are open; all ground pins are grounded.

Typical Diode Capacitance vs. Reverse Voltage

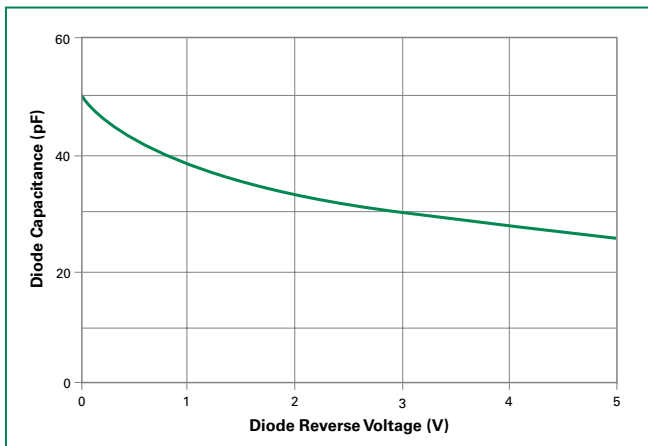

Soldering Parameters

| | | |
|--|------------------------------------|-------------------------|
| Reflow Condition | | Pb – Free assembly |
| Pre Heat | - Temperature Min ($T_{s(min)}$) | 150°C |
| | - Temperature Max ($T_{s(max)}$) | 200°C |
| | - Time (min to max) (t_s) | 60 – 180 secs |
| Average ramp up rate (Liquidus) Temp (T_L) to peak | | 5°C/second max |
| $T_{s(max)}$ to T_L - Ramp-up Rate | | 5°C/second max |
| Reflow | - Temperature (T_L) (Liquidus) | 217°C |
| | - Temperature (t_L) | 60 – 150 seconds |
| Peak Temperature (T_P) | | 260 ^{+0/-5} °C |
| Time within 5°C of actual peak Temperature (t_p) | | 20 – 40 seconds |
| Ramp-down Rate | | 5°C/second max |
| Time 25°C to peak Temperature (T_P) | | 8 minutes Max. |
| Do not exceed | | 260°C |

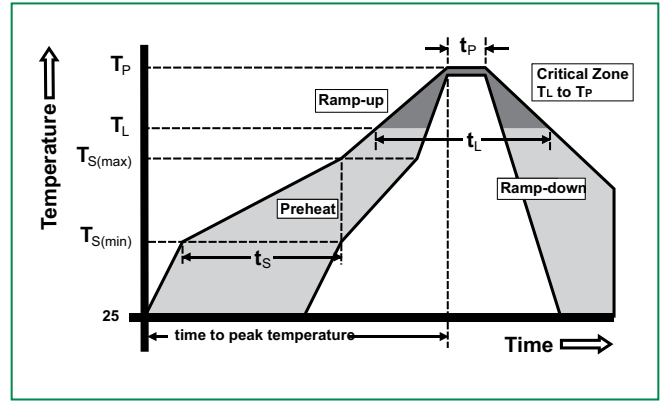

Package Dimensions – SOT143

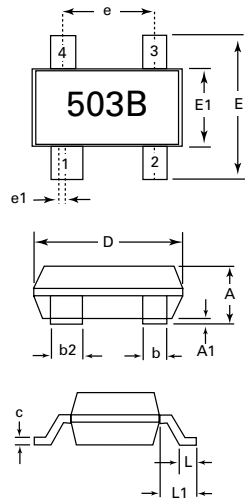

SP0503BAHTG - SOT143-4

Recommended Pad Layout

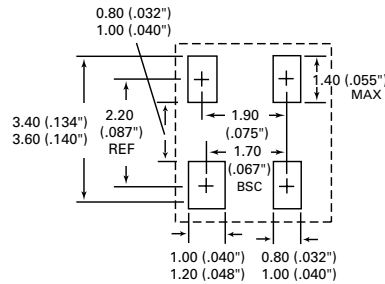

| Package | SOT143-4 | | | |
|-----------|-------------|------|-----------|-------|
| Pins | 4 | | | |
| JEDEC | TO-253 | | | |
| | Millimeters | | Inches | |
| | Min | Max | Min | Max |
| A | 0.8 | 1.22 | 0.03 | 0.048 |
| A1 | 0.05 | 0.15 | 0.002 | 0.006 |
| b | 0.30 | 0.50 | 0.012 | 0.020 |
| b2 | 0.76 | 0.89 | 0.030 | 0.035 |
| c | 0.08 | 0.20 | 0.003 | 0.008 |
| D | 2.80 | 3.04 | 0.110 | 0.120 |
| E | 2.10 | 2.64 | 0.082 | 0.104 |
| E1 | 1.20 | 1.40 | 0.047 | 0.055 |
| e | 1.92 BSC | | 0.076 BSC | |
| e1 | 0.20 BSC | | 0.008 BSC | |
| L | 0.4 | 0.6 | 0.016 | 0.024 |
| L1 | 0.550 REF | | 0.022 REF | |

Package Dimensions — SC70

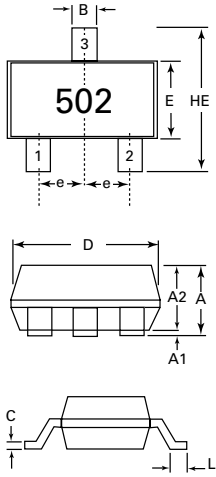

SP0502BAJTG - SC70-3

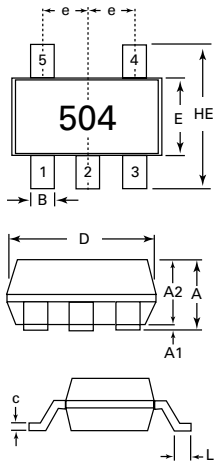

SP0504BAJTG - SC70-5

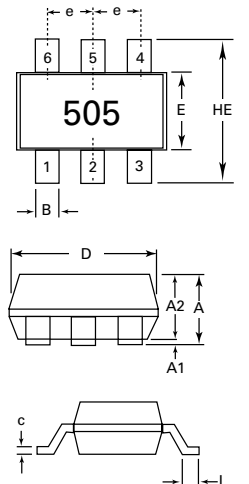

SP0505BAJTG - SC70-6

Recommended Pad Layout

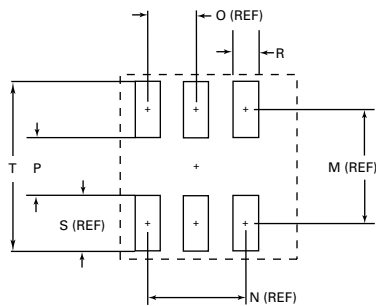

| Package | SC70-3 | | | |
|-----------|-------------|------|-----------|-------|
| Pins | 3 | | | |
| JEDEC | MO-203 | | | |
| | Millimeters | | Inches | |
| | Min | Max | Min | Max |
| A | 0.80 | 1.10 | 0.031 | 0.043 |
| A1 | 0.00 | 0.10 | 0.00 | 0.004 |
| A2 | 0.70 | 1.00 | 0.028 | 0.039 |
| B | 0.15 | 0.30 | 0.006 | 0.012 |
| c | 0.08 | 0.25 | 0.003 | 0.010 |
| D | 1.85 | 2.25 | 0.073 | 0.089 |
| E | 1.15 | 1.35 | 0.045 | 0.053 |
| e | 0.66 BSC | | 0.026 BSC | |
| HE | 2.00 | 2.40 | 0.079 | 0.094 |
| L | 0.26 | 0.46 | 0.010 | 0.018 |

| Package | SC70-5 | | | |
|-----------|-------------|------|-----------|-------|
| Pins | 5 | | | |
| JEDEC | MO-203 | | | |
| | Millimeters | | Inches | |
| | Min | Max | Min | Max |
| A | 0.80 | 1.10 | 0.031 | 0.043 |
| A1 | 0.00 | 0.10 | 0.00 | 0.004 |
| A2 | 0.70 | 1.00 | 0.028 | 0.039 |
| B | 0.15 | 0.30 | 0.006 | 0.012 |
| c | 0.08 | 0.25 | 0.003 | 0.010 |
| D | 1.85 | 2.25 | 0.073 | 0.089 |
| E | 1.15 | 1.35 | 0.045 | 0.053 |
| e | 0.65 BSC | | 0.026 BSC | |
| HE | 2.00 | 2.40 | 0.079 | 0.094 |
| L | 0.26 | 0.46 | 0.010 | 0.018 |

| Package | SC70-6 | | | |
|-----------|-------------|------|-----------|-------|
| Pins | 6 | | | |
| JEDEC | MO-203 | | | |
| | Millimeters | | Inches | |
| | Min | Max | Min | Max |
| A | 0.80 | 1.10 | 0.031 | 0.043 |
| A1 | 0.00 | 0.10 | 0.00 | 0.004 |
| A2 | 0.70 | 1.00 | 0.028 | 0.039 |
| B | 0.15 | 0.30 | 0.006 | 0.012 |
| c | 0.08 | 0.25 | 0.003 | 0.010 |
| D | 1.85 | 2.25 | 0.073 | 0.089 |
| E | 1.15 | 1.35 | 0.045 | 0.053 |
| e | 0.65 BSC | | 0.026 BSC | |
| HE | 2.00 | 2.40 | 0.079 | 0.094 |
| L | 0.26 | 0.46 | 0.010 | 0.018 |
| M | - | 1.60 | - | 0.063 |
| N | - | 1.30 | - | 0.051 |
| O | - | 0.65 | - | 0.026 |
| P | - | 0.70 | - | 0.028 |
| R | - | 0.35 | - | 0.014 |
| S | - | 0.90 | - | 0.035 |
| T | - | 2.50 | - | 0.098 |

Package Dimensions – SOT23

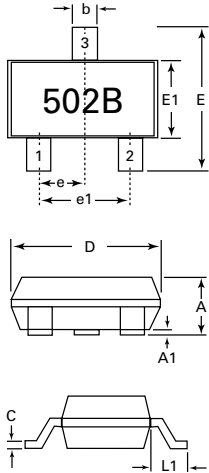

SP0502BAHTG - SOT23-3

Recommended Pad Layout

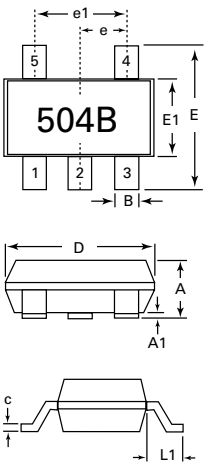
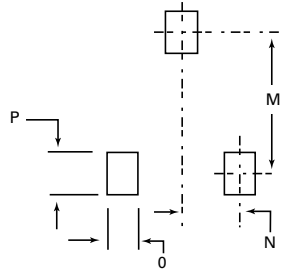

SP0504BAHTG - SOT23-5

Recommended Pad Layout

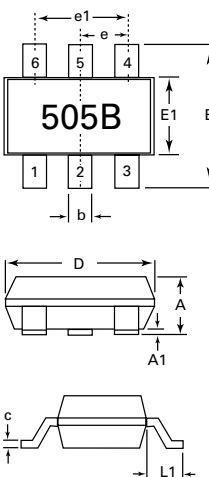
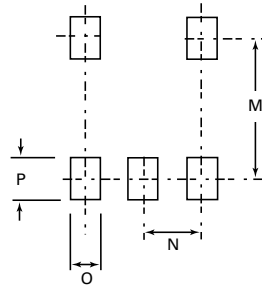

SP0505BAHTG - SOT23-6

Recommended Pad Layout

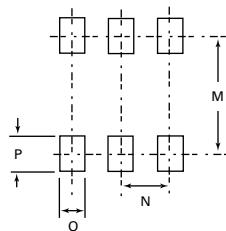

| Package | SOT23-3 | | | |
|-----------|-------------|------|-----------|---------|
| Pins | 3 | | | |
| JEDEC | TO-236 | | | |
| | Millimeters | | Inches | |
| | Min | Max | Min | Max |
| A | 0.89 | 1.12 | 0.035 | 0.044 |
| A1 | 0.01 | 0.1 | 0.0004 | 0.004 |
| b | 0.3 | 0.5 | 0.012 | 0.020 |
| c | 0.08 | 0.2 | 0.003 | 0.008 |
| D | 2.8 | 3.04 | 0.110 | 0.120 |
| E | 2.1 | 2.64 | 0.083 | 0.104 |
| E1 | 1.2 | 1.4 | 0.047 | 0.055 |
| e | 0.95 BSC | | 0.038 BSC | |
| e1 | 1.90 BSC | | 0.075 BSC | |
| L1 | 0.54 REF | | 0.021 REF | |
| M | | 2.29 | | .090 |
| N | | 0.95 | | 0.038 |
| O | | 0.78 | | .030TYP |
| P | | 0.78 | | .030TYP |

| Package | SOT23-5 | | | |
|-----------|-------------|------|-----------|---------|
| Pins | 5 | | | |
| JEDEC | MO-178 | | | |
| | Millimeters | | Inches | |
| | Min | Max | Min | Max |
| A | - | 1.45 | - | 0.057 |
| A1 | 0 | 0.15 | 0 | 0.006 |
| b | 0.3 | 0.5 | 0.012 | 0.020 |
| c | 0.08 | 0.22 | 0.003 | 0.009 |
| D | 2.75 | 3.05 | 0.108 | 0.120 |
| E | 2.6 | 3.0 | 0.102 | 0.118 |
| E1 | 1.45 | 1.75 | 0.057 | 0.069 |
| e | 0.95 BSC | | 0.038 BSC | |
| e1 | 1.90 BSC | | 0.075 BSC | |
| L1 | 0.60 REF | | 0.024 REF | |
| M | | 2.59 | | .102 |
| N | | 0.95 | | .038 |
| O | | 0.69 | | .027TYP |
| P | | 0.99 | | .039TYP |

| Package | SOT23-6 | | | |
|-----------|-------------|------|-----------|---------|
| Pins | 6 | | | |
| JEDEC | MO-178 | | | |
| | Millimeters | | Inches | |
| | Min | Max | Min | Max |
| A | - | 1.45 | - | 0.057 |
| A1 | 0 | 0.15 | 0 | 0.006 |
| b | 0.3 | 0.5 | 0.012 | 0.020 |
| c | 0.08 | 0.22 | 0.003 | 0.009 |
| D | 2.75 | 3.05 | 0.108 | 0.120 |
| E | 2.6 | 3.0 | 0.102 | 0.118 |
| E1 | 1.45 | 1.75 | 0.057 | 0.069 |
| e | 0.95 BSC | | 0.038 BSC | |
| e1 | 1.90 BSC | | 0.075 BSC | |
| L1 | 0.60 REF | | 0.024 REF | |
| M | | 2.59 | | .102 |
| N | | 0.95 | | 0.038 |
| O | | 0.69 | | .027TYP |
| P | | 0.99 | | .039TYP |

Package Dimensions – MSOP

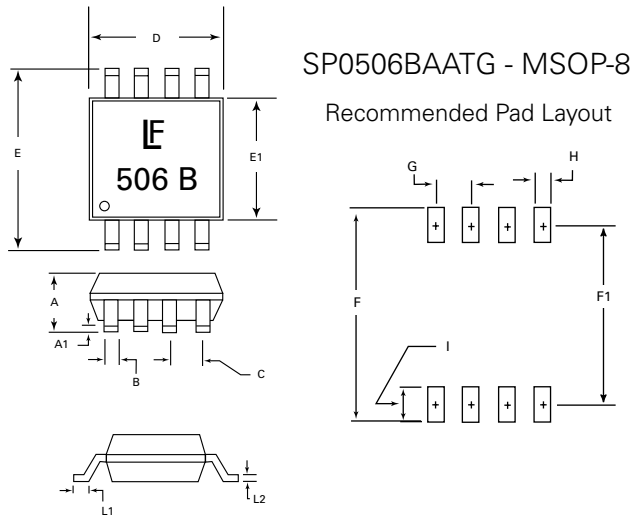

| Package | MSOP | | | |
|-----------|-------------|---------|--------|----------|
| Pins | 8 | | | |
| JEDEC | MO-187 | | | |
| | Millimeters | | Inches | |
| | Min | Max | Min | Max |
| D | 2.90 | 3.10 | 0.114 | .122 |
| E | 4.78 | 4.98 | .188 | .196 |
| E1 | 2.90 | 3.10 | .114 | .122 |
| A | 0.87 | 1.17 | .034 | .046 |
| A1 | 0.05 | 0.25 | .002 | 0.010 |
| B | - | 0.30TYP | - | 0.012TYP |
| C | - | 0.65TYP | - | 0.026TYP |
| L1 | 0.52 | 0.54 | 0.020 | 0.021 |
| L2 | - | 0.18TYP | - | .007TYP |
| F | - | 5.28 | - | .208 |
| F1 | - | 4.24 | - | .167 |
| G | - | 0.65 | - | 0.026 |
| H | - | 0.38 | - | .015 |
| I | - | 1.04 | - | .041 |

Part Numbering System

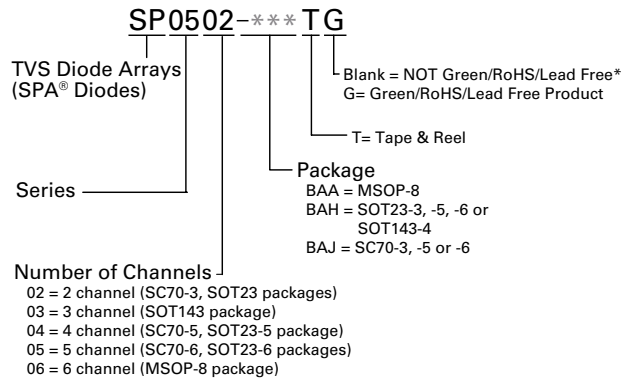

Product Characteristics

| | |
|---------------------------|--|
| Lead Plating | "G" Green version - Matte Tin (Sn) |
| Lead Material | Copper / Iron Alloy |
| Lead Coplanarity | 0.004 inches (0.102mm) |
| Substrate Material | Silicon |
| Body Material | Molded Compound |
| Flammability | UL Recognized compound meeting flammability rating V-0 |

Notes:

- All dimensions are in millimeters.
- Dimensions include solder plating.
- Dimensions are exclusive of mold flash & metal burr.
- Blo is facing up for mold and facing down for trim/form, i.e. reverse trim/form.
- Package surface matte finish VDI 11-13.

Ordering Information

*NOTE: To order NON-Green/RoHS/Lead Free version of product, remove "G" at the end of part number.

| Part Number | CH | Package Type | Quantity Per Reel |
|-------------|----|--------------|-------------------|
| SP0502BAHTG | 2 | SOT23-3 | 3000 |
| SP0503BAHTG | 3 | SOT143-4 | 3000 |
| SP0504BAHTG | 4 | SOT23-5 | 3000 |
| SP0505BAHTG | 5 | SOT23-6 | 3000 |
| SP0506BAATG | 6 | MSOP-8 | 4000 |
| SP0502BAJTG | 2 | SC70-3 | 3000 |
| SP0504BAJTG | 4 | SC70-5 | 3000 |
| SP0505BAJTG | 5 | SC70-6 | 3000 |

Embossed Carrier Tape & Reel Specification – SOT23-3

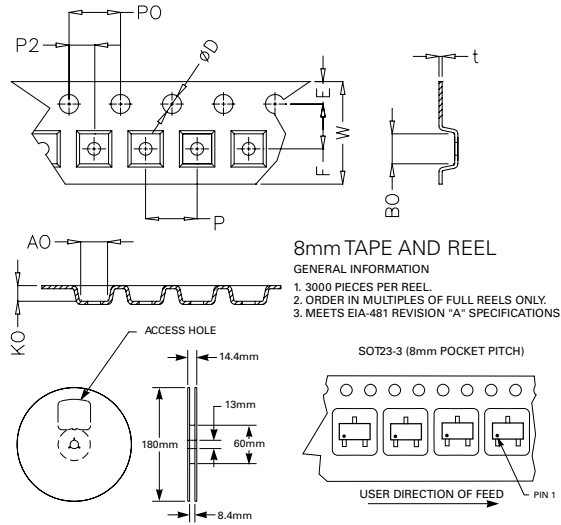

| Symbol | Millimetres | | Inches | |
|-----------|-------------|------|--------|-------|
| | Min | Max | Min | Max |
| E | 1.65 | 1.85 | 0.065 | 0.073 |
| F | 3.40 | 3.60 | 0.134 | 0.142 |
| P2 | 1.90 | 2.10 | 0.075 | 0.083 |
| D | 1.40 | 1.60 | 0.055 | 0.063 |
| P0 | 3.90 | 4.10 | 0.154 | 0.161 |
| W | 7.70 | 8.30 | 0.303 | 0.327 |
| P | 3.90 | 4.10 | 0.154 | 0.161 |
| A0 | 3.05 | 3.25 | 0.120 | 0.128 |
| B0 | 2.67 | 2.87 | 0.105 | 0.113 |
| K0 | 1.12 | 1.32 | 0.044 | 0.052 |
| t | 0.22 | 0.24 | 0.009 | 0.009 |

Embossed Carrier Tape & Reel Specification – SOT23-5

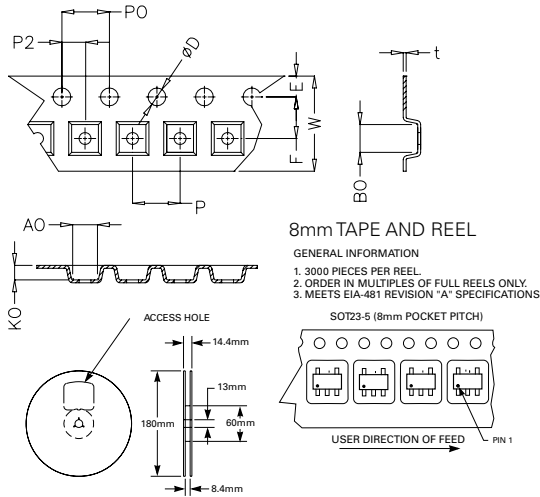

| Symbol | Millimetres | | Inches | |
|-----------|-------------|------|--------|-------|
| | Min | Max | Min | Max |
| E | 1.65 | 1.85 | 0.065 | 0.073 |
| F | 3.40 | 3.60 | 0.134 | 0.142 |
| P2 | 1.90 | 2.10 | 0.075 | 0.083 |
| D | 1.40 | 1.60 | 0.055 | 0.063 |
| P0 | 3.90 | 4.10 | 0.154 | 0.161 |
| W | 7.70 | 8.30 | 0.303 | 0.327 |
| P | 3.90 | 4.10 | 0.154 | 0.161 |
| A0 | 3.05 | 3.25 | 0.120 | 0.128 |
| B0 | 2.67 | 2.87 | 0.105 | 0.113 |
| K0 | 1.12 | 1.32 | 0.044 | 0.052 |
| t | 0.22 | 0.24 | 0.009 | 0.009 |

Embossed Carrier Tape & Reel Specification – SOT23-6

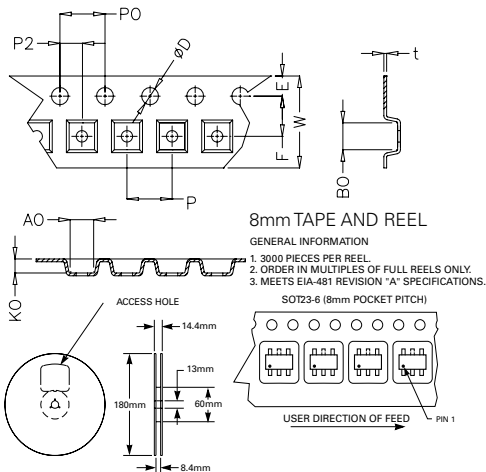

| Symbol | Millimetres | | Inches | |
|-----------|-------------|------|--------|-------|
| | Min | Max | Min | Max |
| E | 1.65 | 1.85 | 0.065 | 0.073 |
| F | 3.40 | 3.60 | 0.134 | 0.142 |
| P2 | 1.90 | 2.10 | 0.075 | 0.083 |
| D | 1.40 | 1.60 | 0.055 | 0.063 |
| P0 | 3.90 | 4.10 | 0.154 | 0.161 |
| W | 7.70 | 8.30 | 0.303 | 0.327 |
| P | 3.90 | 4.10 | 0.154 | 0.161 |
| A0 | 3.05 | 3.25 | 0.120 | 0.128 |
| B0 | 2.67 | 2.87 | 0.105 | 0.113 |
| K0 | 1.12 | 1.32 | 0.044 | 0.052 |
| t | 0.22 | 0.24 | 0.009 | 0.009 |

Embossed Carrier Tape & Reel Specification – SOT143-4

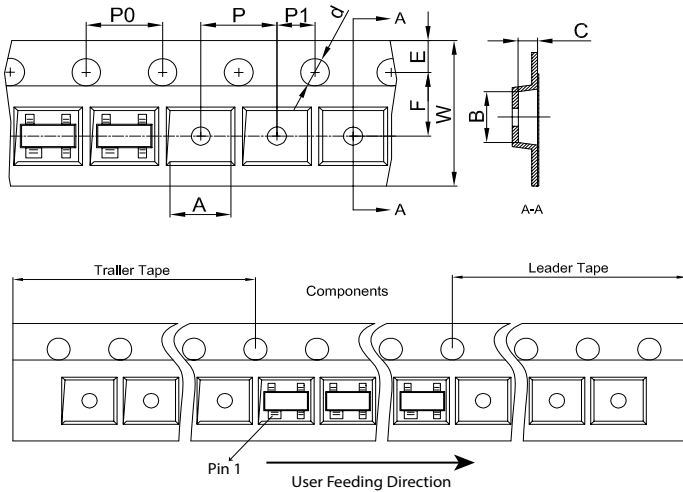

| Symbol | Millimetres | | Inches | |
|--------|-------------|------|--------|-------|
| | Min | Max | Min | Max |
| A | 3.09 | 3.09 | 0.122 | 0.130 |
| B | 2.70 | 2.90 | 1.106 | 0.114 |
| C | 1.21 | 1.41 | 0.048 | 0.056 |
| d | 1.40 | 1.60 | 0.055 | 0.102 |
| E | 1.65 | 0.85 | 0.065 | 0.073 |
| F | 3.45 | 3.65 | 0.133 | 0.142 |
| P0 | 4.10 | 3.90 | 0.154 | 0.161 |
| P | 4.10 | 3.90 | 0.154 | 0.161 |
| P1 | 1.90 | 2.10 | 0.075 | 0.083 |
| W | 7.90 | 8.10 | 0.311 | 0.319 |

Embossed Carrier Tape & Reel Specification – MSOP-8

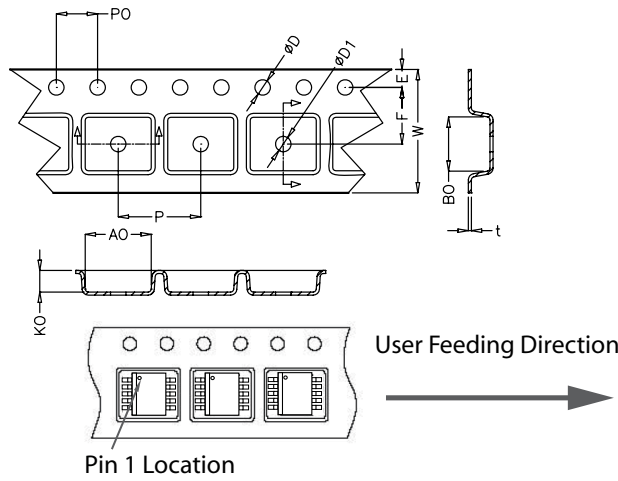

| | Millimetres | | Inches | |
|----|-------------|-------|---------------|-------|
| | Min | Max | Min | Max |
| E | 1.65 | 1.85 | 0.065 | 0.073 |
| F | 5.40 | 5.60 | 0.213 | 0.220 |
| D | 1.50 | 1.60 | 0.059 | 0.063 |
| D1 | 1.50 Min | | 0.059 Min | |
| P0 | 3.90 | 4.10 | 0.154 | 0.161 |
| W | 11.70 | 12.30 | 0.461 | 0.484 |
| P | 7.90 | 8.10 | 0.311 | 0.319 |
| AO | 5.20 | 5.40 | 0.205 | 0.213 |
| B0 | 3.30 | 3.40 | 0.126 | 0.134 |
| K0 | 1.20 | 1.40 | 0.047 | 0.055 |
| t | 0.30 ± 0.05 | | 0.012 ± 0.002 | |

Embossed Carrier Tape & Reel Specification – SC70-3

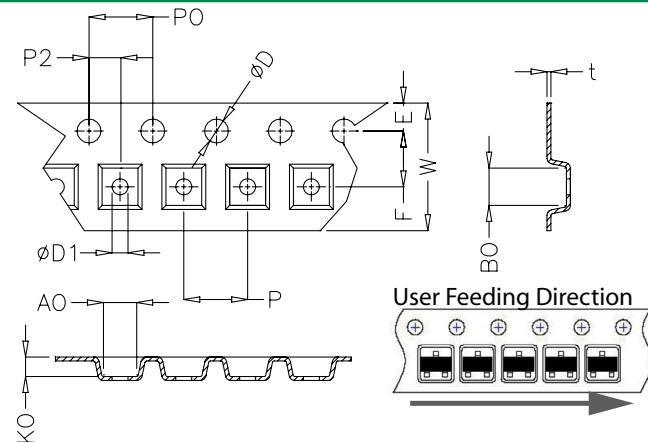

| Symbol | Millimetres | | Inches | |
|--------|-------------|------|-----------|-------|
| | Min | Max | Min | Max |
| E | 1.65 | 1.85 | 0.064 | 0.073 |
| F | 3.45 | 3.55 | 0.135 | 0.139 |
| P2 | 1.95 | 2.05 | 0.077 | 0.081 |
| D | 1.40 | 1.60 | 0.055 | 0.063 |
| D1 | 1.00 | 1.25 | 0.039 | 0.049 |
| P0 | 3.90 | 4.10 | 0.154 | 0.161 |
| W | 7.70 | 8.10 | 0.303 | 0.318 |
| P | 3.90 | 4.10 | 0.153 | 0.161 |
| AO | 2.14 | 2.34 | 0.084 | 0.092 |
| B0 | 2.24 | 2.44 | 0.088 | 0.096 |
| K0 | 1.12 | 1.32 | 0.044 | 0.052 |
| t | 0.27 Max | | 0.010 Max | |

Embossed Carrier Tape & Reel Specification – SC70-5

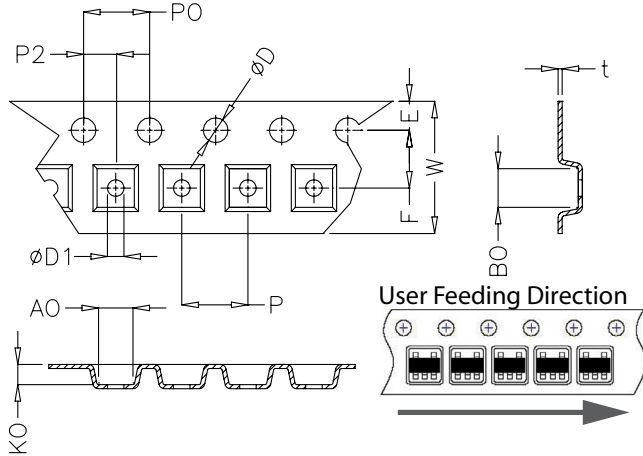

| Symbol | Millimetres | | Inches | |
|-----------|-------------|------|-----------|-------|
| | Min | Max | Min | Max |
| E | 1.65 | 1.85 | 0.064 | 0.073 |
| F | 3.45 | 3.55 | 0.135 | 0.139 |
| P2 | 1.95 | 2.05 | 0.077 | 0.081 |
| D | 1.40 | 1.60 | 0.055 | 0.063 |
| D1 | 1.00 | 1.25 | 0.039 | 0.049 |
| P0 | 3.90 | 4.10 | 0.154 | 0.161 |
| W | 7.70 | 8.10 | 0.303 | 0.318 |
| P | 3.90 | 4.10 | 0.153 | 0.161 |
| A0 | 2.14 | 2.34 | 0.084 | 0.092 |
| B0 | 2.24 | 2.44 | 0.088 | 0.096 |
| K0 | 1.12 | 1.32 | 0.044 | 0.052 |
| t | 0.27 Max | | 0.010 Max | |

Embossed Carrier Tape & Reel Specification – SC70-6

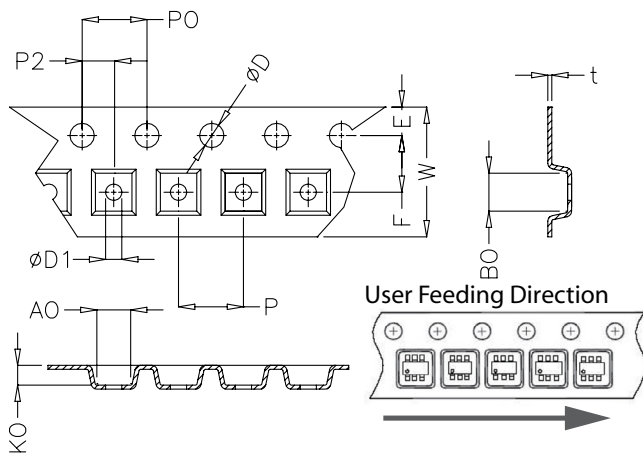

| Symbol | Millimetres | | Inches | |
|-----------|-------------|------|-----------|-------|
| | Min | Max | Min | Max |
| E | 1.65 | 1.85 | 0.064 | 0.073 |
| F | 3.45 | 3.55 | 0.135 | 0.139 |
| P2 | 1.95 | 2.05 | 0.077 | 0.081 |
| D | 1.40 | 1.60 | 0.055 | 0.063 |
| D1 | 1.00 | 1.25 | 0.039 | 0.049 |
| P0 | 3.90 | 4.10 | 0.154 | 0.161 |
| W | 7.70 | 8.10 | 0.303 | 0.318 |
| P | 3.90 | 4.10 | 0.153 | 0.161 |
| A0 | 2.14 | 2.34 | 0.084 | 0.092 |
| B0 | 2.24 | 2.44 | 0.088 | 0.096 |
| K0 | 1.12 | 1.32 | 0.044 | 0.052 |
| t | 0.27 Max | | 0.010 Max | |

Disclaimer Notice - Information furnished is believed to be accurate and reliable. However, users should independently evaluate the suitability of and test each product selected for their own applications. Littelfuse products are not designed for, and may not be used in, all applications. Read complete Disclaimer Notice at www.littelfuse.com/disclaimer-electronics.

Mouser Electronics

Authorized Distributor

Click to View Pricing, Inventory, Delivery & Lifecycle Information:

Littelfuse:

[SP0502BAHTG](#) [SP0502BAJTG](#) [SP0504BAATG](#) [SP0504BAJTG](#) [SP0505BAJTG](#) [SP0506BAATG](#) [SP0505BAHT](#)
[SP0504BAHTG](#) [SP0503BAHTG](#) [SP0505BAHTG](#) [SP0506BAAT](#) [SP0503BAHT](#) [SP0504BAHT](#) [SP0504BAJT](#)
[SP0505BAJT](#) [SP0504BAAT](#)