

RFMD Green, RoHS Compliant, Pb-Free Product  
Package: SOF-26

**Product Description**

RFMD's SPA-1526Z is a high linearity single-stage class A Heterojunction Bipolar Transistor (HBT) power amplifier. The SPA-1526Z is made with InGaP-on-GaAs device technology and fabricated with MOCVD for an ideal combination of low cost and high reliability. It is well suited for use as a driver stage in macro/micro-cell infrastructure equipment, or as the final output stage in pico-cell infrastructure equipment. It features an input power detector, on/off power control, ESD protection, excellent overall robustness, and a hand reworkable and thermally enhanced SOF-26 package.

**Optimum Technology Matching® Applied**

- GaAs HBT
- GaAs MESFET
- InGaP HBT
- SiGe BiCMOS
- Si BiCMOS
- SiGe HBT
- GaAs pHEMT
- Si CMOS
- Si BJT
- GaN HEMT
- RF MEMS

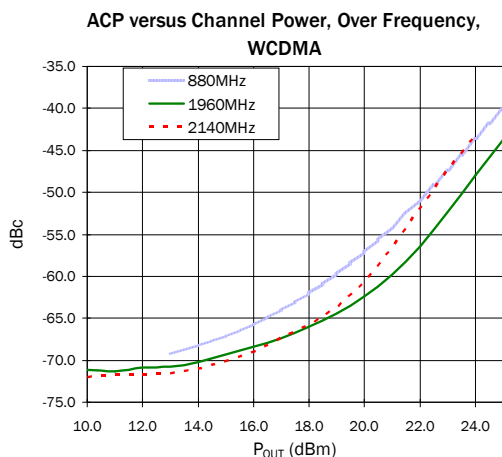

**Features**

- P<sub>1dB</sub> = 32 dBm @ 2140 MHz
- ACP = -65 dBc with 18.4 dBm Channel Power @ 2140 MHz
- Low Thermal Resistance Package
- Power Up/Down Control < 1 μs
- Robust Class 1C ESD

**Applications**

- Macro/Micro-Cell Driver Stage
- Pico-Cell Output Stage
- GSM, CDMA, TDSCDMA, WCDMA, IS-95
- Single and Multi-Carrier Applications

Parameter	Specification			Unit	Condition
	Min.	Typ.	Max.		
Small Signal Power Gain		15.4		dB	885 MHz
		14.0		dB	1960 MHz
		13.5		dB	2140 MHz
Output Power at 1dB Compression		32.5		dBm	885 MHz
		32.5		dBm	1960 MHz
		32.0		dBm	2140 MHz
Output Third Order Intercept Point		45.5		dBm	885 MHz
		49.0		dBm	1960 MHz
		49.0		dBm	2140 MHz
WCDMA Channel Power					3GPP 3.5, test model 1, 64 DPCH
-65dBc ACP		16.5		dBm	885 MHz
-55dBc ACP		20.7		dBm	885 MHz
-65dBc ACP		18.6		dBm	1960 MHz
-55dBc ACP		22.3		dBm	1960 MHz
-65dBc ACP		18.4		dBm	2140 MHz
-55dBm ACP		21.3		dBm	2140 MHz
Input Return Loss		20.0		dB	1960 MHz
Output Return Loss		14.5		dB	1960 MHz
Noise Figure		5.5		dB	1960 MHz
Quiescent Current (V <sub>CC</sub> =5V)		645		mA	
Operating Voltage		5.0	5.5	V	
Operating Current (V <sub>CC</sub> =5V), Quiescent		645		mA	
Power Up Control Current (V <sub>PC</sub> =5V)		2.1		mA	
V <sub>CC</sub> Leakage Current (V <sub>CC</sub> =5V, V <sub>PC</sub> =0V)			100	μA	
Thermal Resistance (junction to lead)		12.0		°C/W	

Test Conditions: V<sub>CC</sub>=5V I<sub>CQ</sub>=645mA Typ. T<sub>L</sub>=25°C Z<sub>S</sub>=Z<sub>L</sub>=50Ω

RF MICRO DEVICES®, RFMD®, Optimum Technology Matching®, Enabling Wireless Connectivity™, PowerStar®, POLARIS™ TOTAL RADIO™ and UltimateBlue™ are trademarks of RFMD, LLC. BLUETOOTH is a trademark owned by Bluetooth SIG, Inc., U.S.A. and licensed for use by RFMD. All other trade names, trademarks and registered trademarks are the property of their respective owners. ©2006, RF Micro Devices, Inc.

## Absolute Maximum Ratings

Parameter	Rating	Unit
Max Device Current ( $I_{CE}$ )	1500	mA
*Max Device Voltage ( $V_{CC}$ )	6.0	V
Power Dissipation	6	W
Max CW Input Power		
50 $\Omega$ output load	33	dBm
10:1 VSWR output load	21	dBm
**Max Modulated (W-CDMA) Input Power		
50 $\Omega$ output load	26	dBm
10:1 VSWR output load	18	dBm
Max RF Output Power with 50 $\Omega$ output load (Continuous long term operation)	30	dBm
Max Junction Temperature ( $T_J$ )	150	$^{\circ}$ C
Operating Temperature Range ( $T_L$ )	-40 to + 85	$^{\circ}$ C
Max Storage Temperature	150	$^{\circ}$ C
ESD Rating - Human Body Model (HBM)	Class 1C	
Moisture Sensitivity Level	MSL 1	



**Caution!** ESD sensitive device.

Exceeding any one or a combination of the Absolute Maximum Rating conditions may cause permanent damage to the device. Extended application of Absolute Maximum Rating conditions to the device may reduce device reliability. Specified typical performance or functional operation of the device under Absolute Maximum Rating conditions is not implied.

RoHS status based on EUDirective2002/95/EC (at time of this document revision).

The information in this publication is believed to be accurate and reliable. However, no responsibility is assumed by RF Micro Devices, Inc. ("RFMD") for its use, nor for any infringement of patents, or other rights of third parties, resulting from its use. No license is granted by implication or otherwise under any patent or patent rights of RFMD. RFMD reserves the right to change component circuitry, recommended application circuitry and specifications at any time without prior notice.

\*No RF Drive

\*\*W-CDMA, 64 DPCH, 1 CH Forward

Operation of this device beyond any one of these limits may cause permanent damage. For reliable continuous operation, the device voltage and current must not exceed the maximum operating values specified in the table on page one.

Bias Conditions should also satisfy the following expression:

$$I_D V_D < (T_J - T_L) / R_{TH}, J-I \text{ and } T_L = T_{LEAD}$$

## Simplified Device Schematic

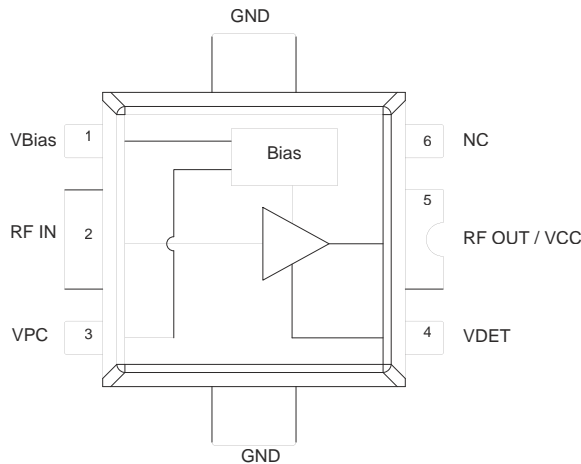

**Typical RF Performance 850MHz to 910MHz Application Circuit**

**ACP versus Channel Power, 880MHz, WCDMA**

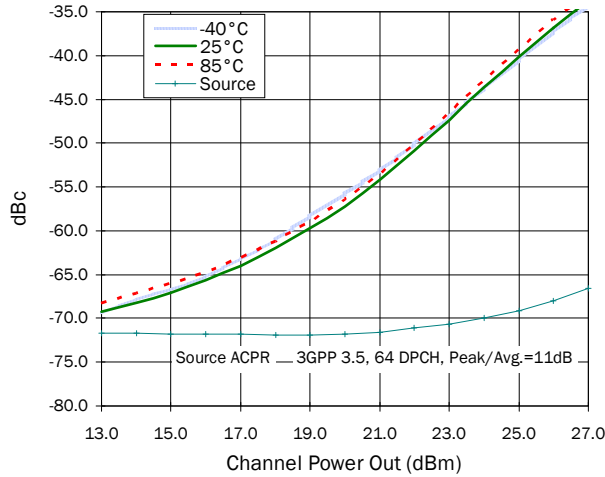

**ACP versus Channel Power, 880MHz, IS-95**

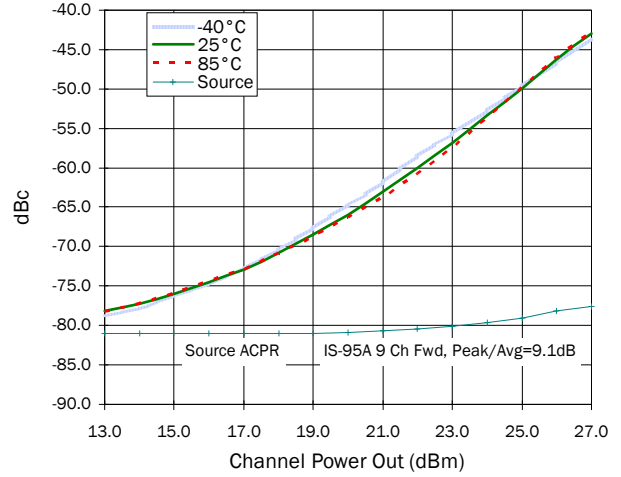

**ACP versus Channel Power, W-CDMA, 25 °C**

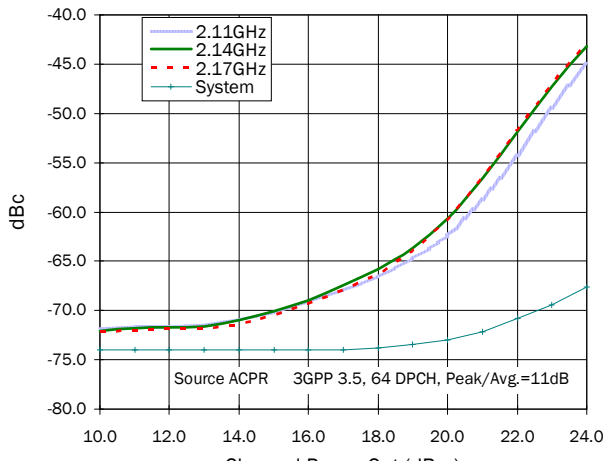

**ACP versus Channel Power, IS-95, 25 °C**

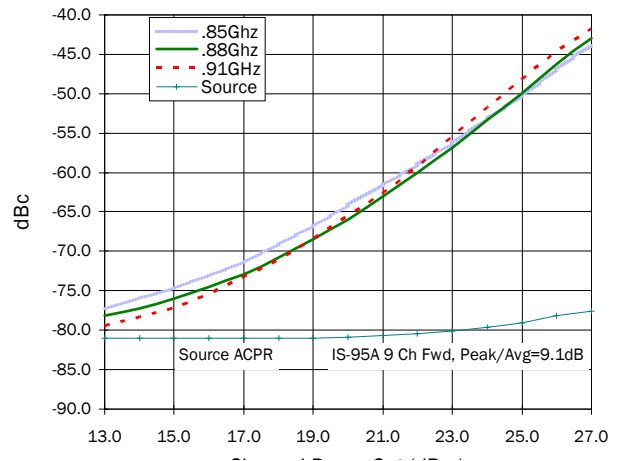

**P1dB versus Frequency**

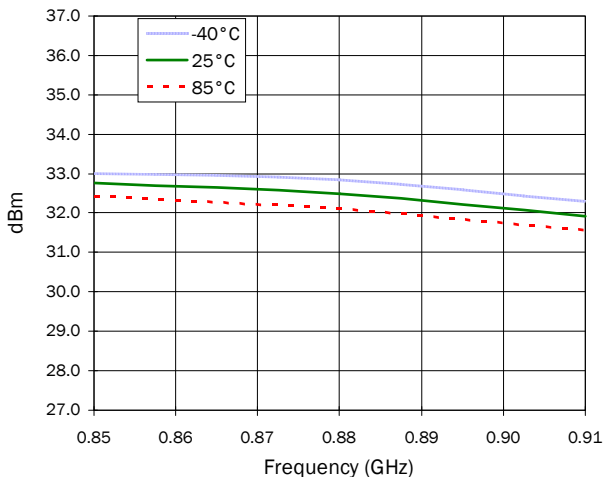

**OIP3 versus Frequency, 22dBm/Tone**

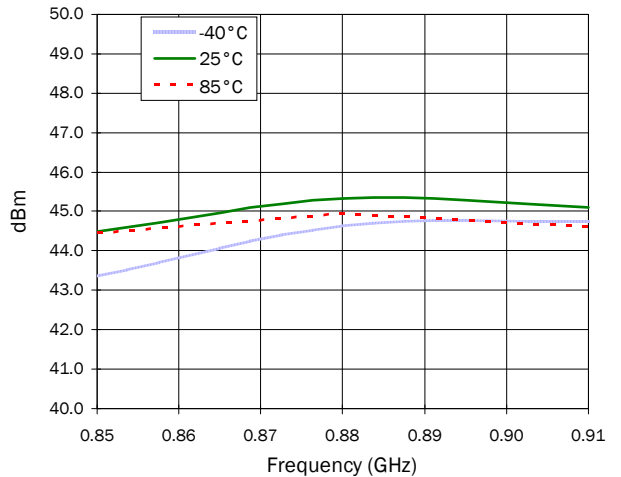

# SPA-1526Z

Preliminary



rfmd.com

## Typical RF Performance 850MHz to 910MHz Application Circuit

S11 versus Frequency

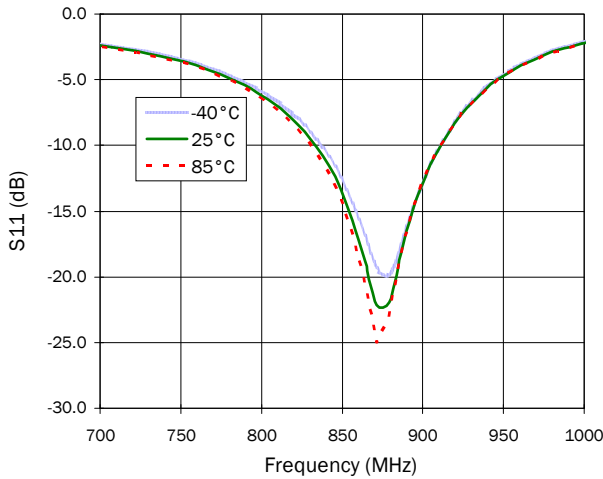

S21 versus Frequency

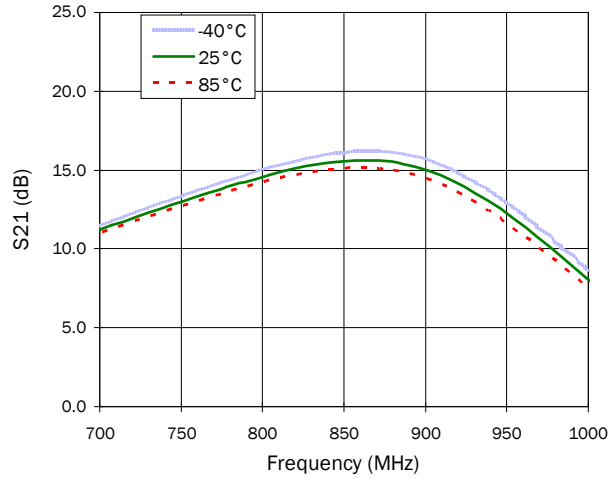

S12 versus Frequency

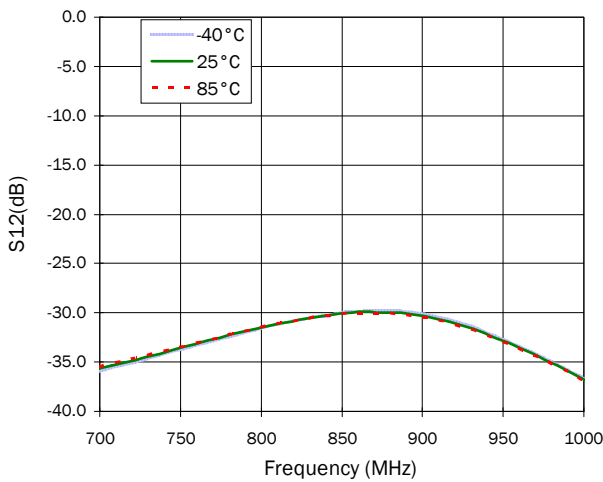

S22 versus Frequency

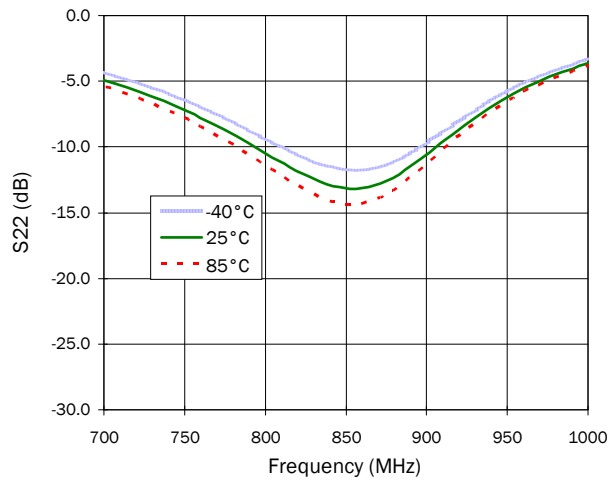

Noise Figure, 5V, 25 °C

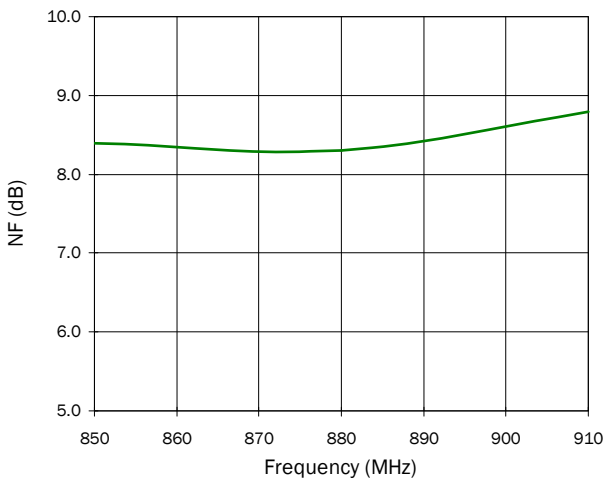

VDETECT versus Output Power @880MHz

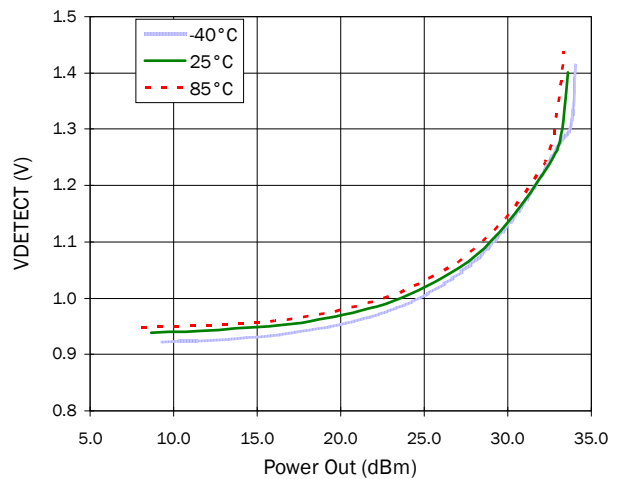

Typical RF Performance 1930MHz to 1960MHz Application Circuit

ACP versus Channel Power, 1960MHz, W-CDMA

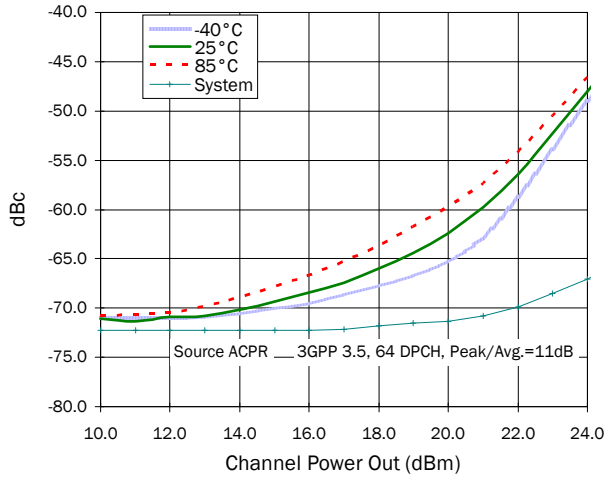

ACP versus Channel Power, 1960MHz, IS-95

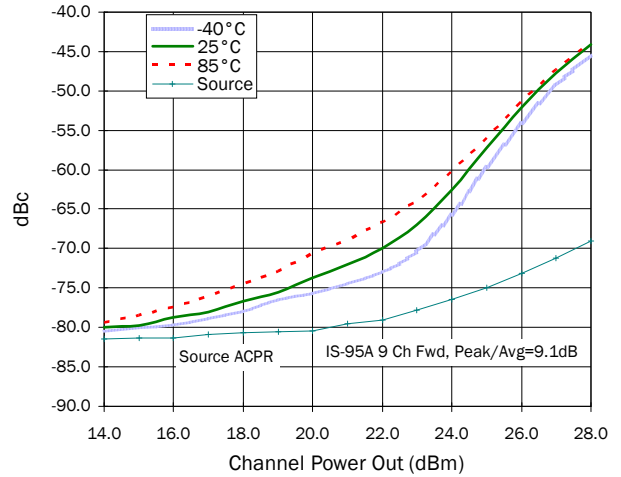

ACP versus Channel Power, W-CDMA, 25 °C

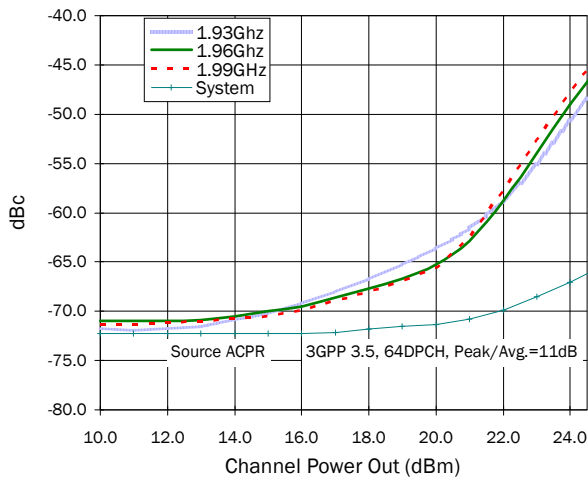

ACP versus Channel Power, IS-95, 25 °C

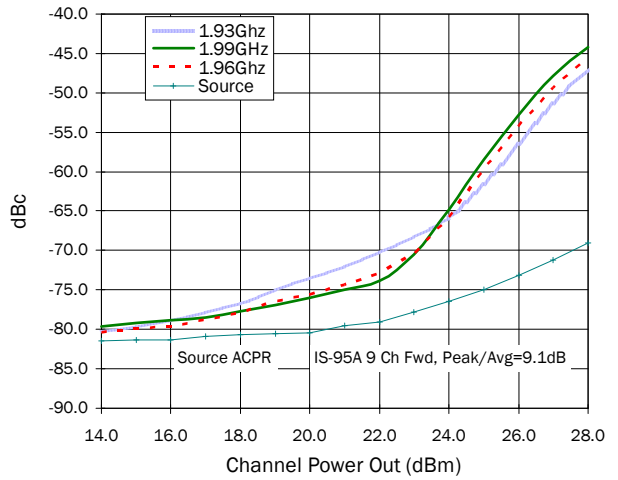

P1dB versus Frequency

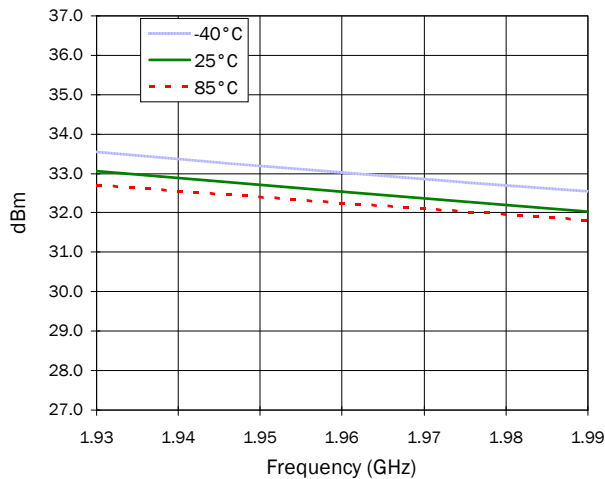

OIP3 versus Frequency, 22dBm/tone

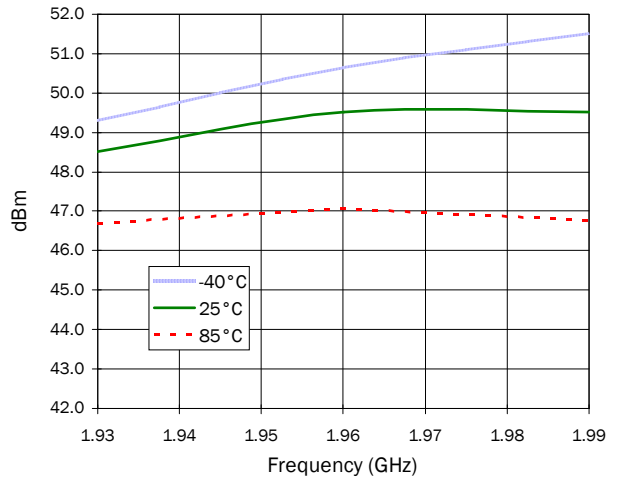

Typical RF Performance 1930MHz to 1990MHz Application Circuit

S11 versus Frequency

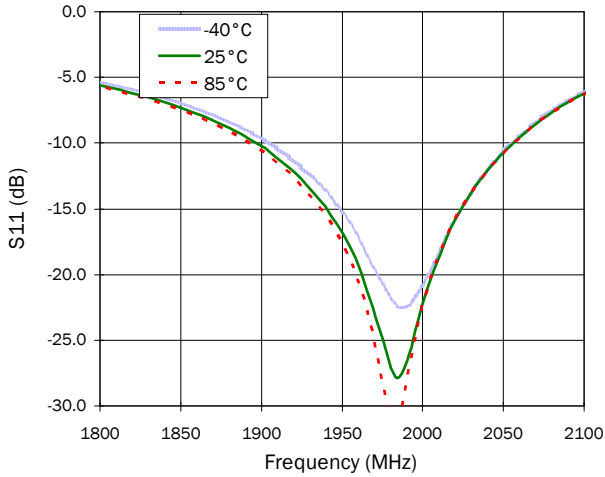

S21 versus Frequency

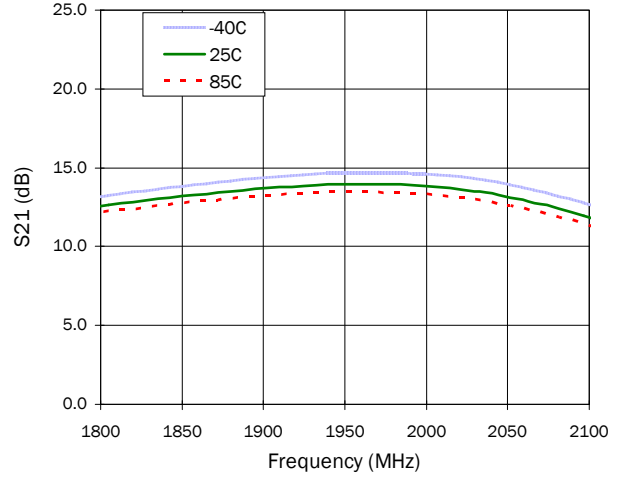

S12 versus Frequency

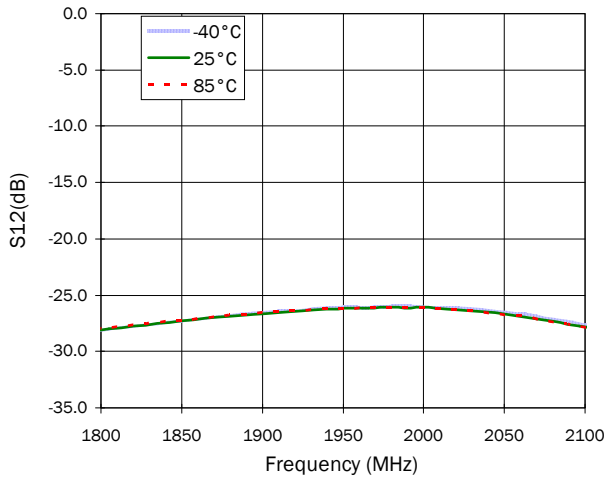

S22 versus Frequency

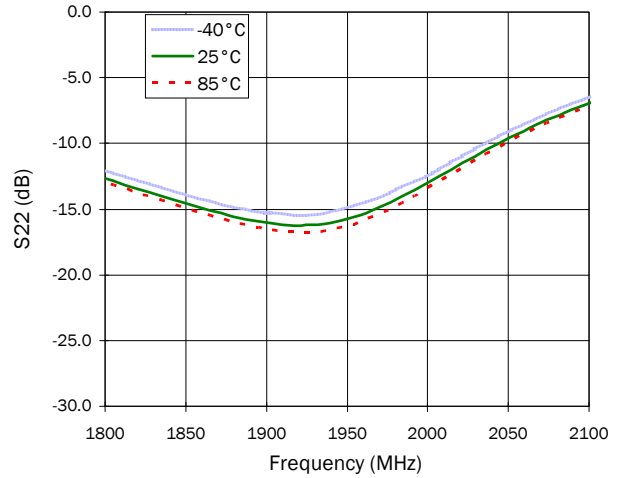

Noise Figure, 5V 25°C

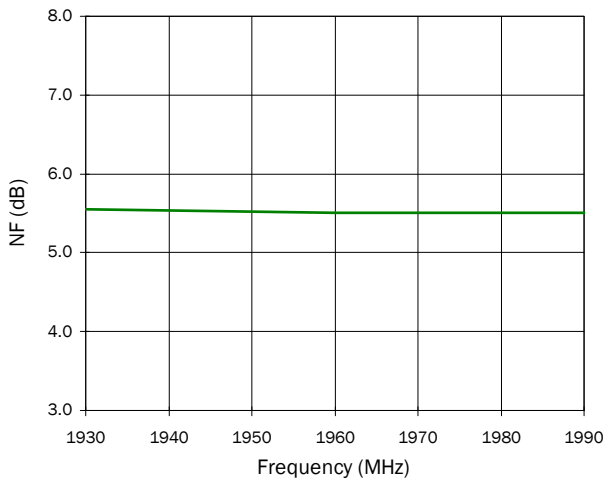

VDETECT versus Output Power @1960MHz

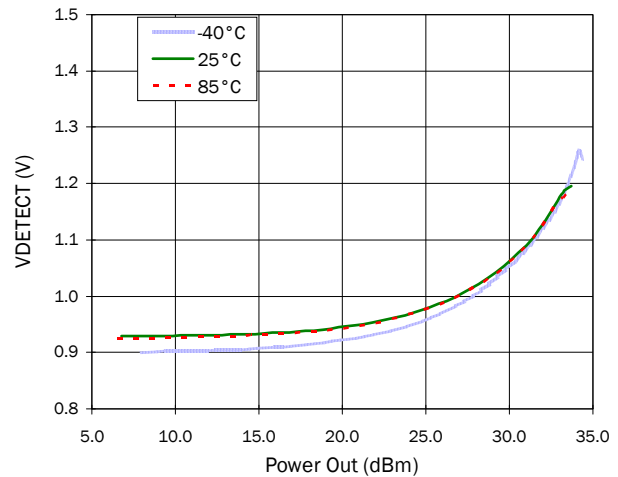

Typical RF Performance 2110MHz to 2170MHz Application Circuit

ACP versus Channel Power, 2140MHz, W-CDMA

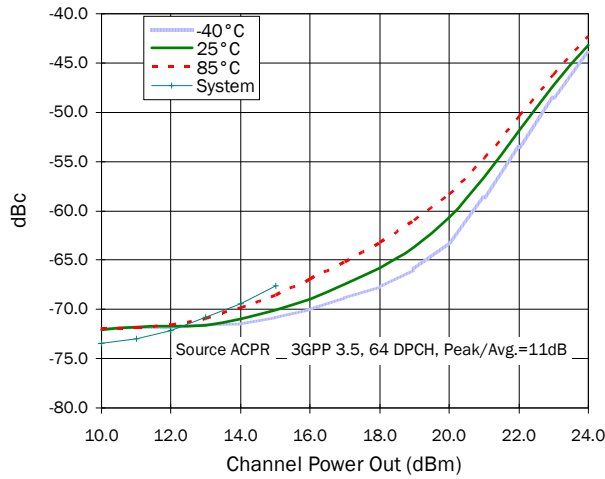

ACP versus Channel Power, W-CDMA, 25 °C

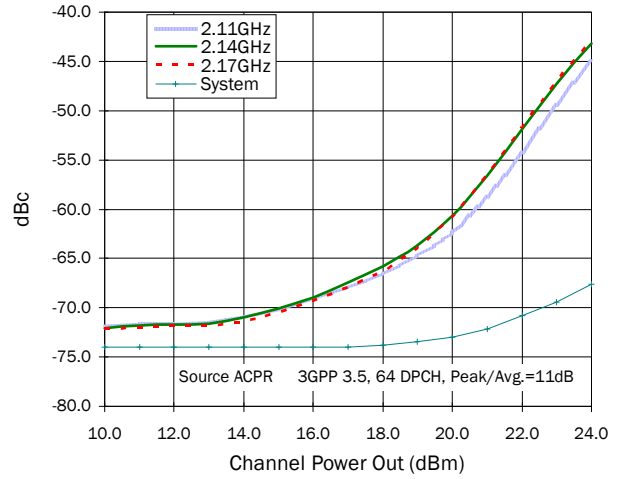

P1dB versus Frequency

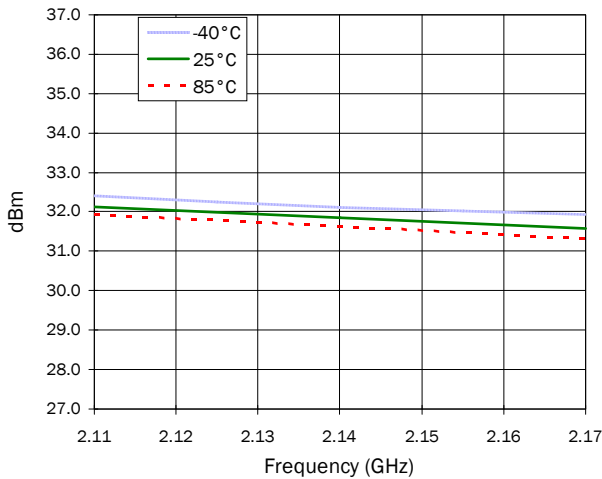

OIP3 versus Frequency, 22dBm/Tone

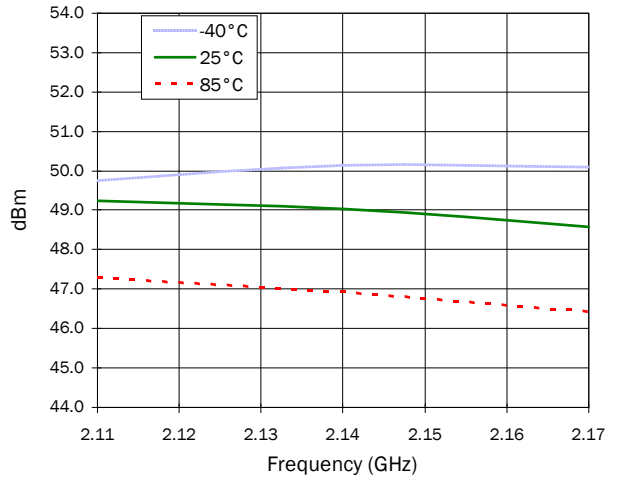

Noise Figure, 5V, 25 °C

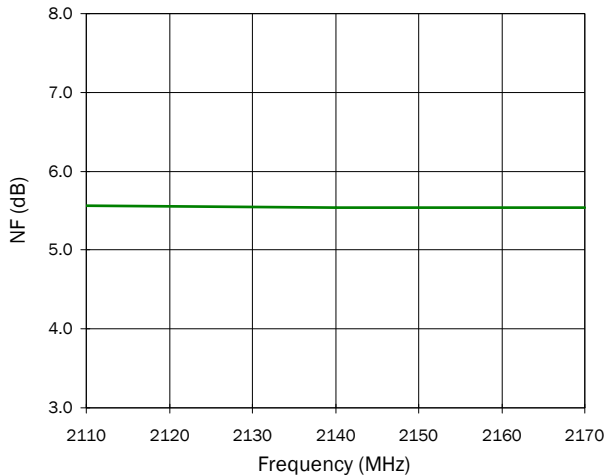

VDETECT versus Output Power @ 2140MHz

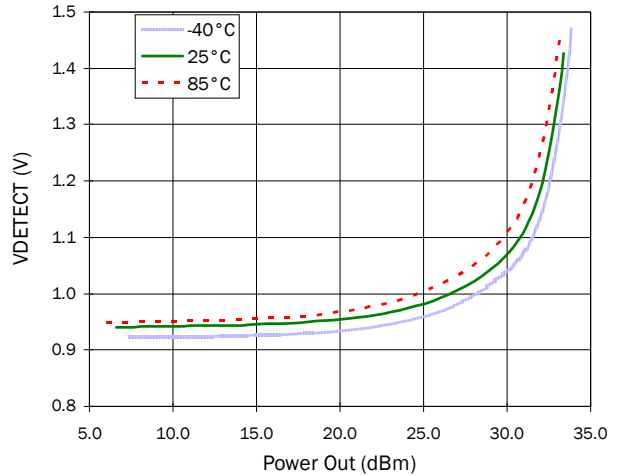

## Typical RF Performance 2110MHz to 2170MHz Application Circuit

### S11 versus Frequency

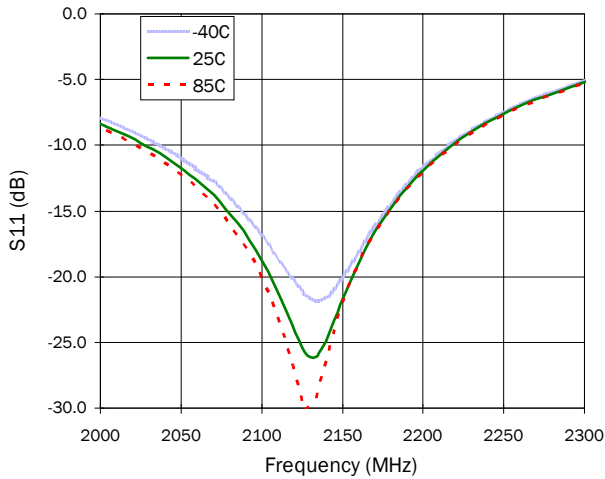

### S21 versus Frequency

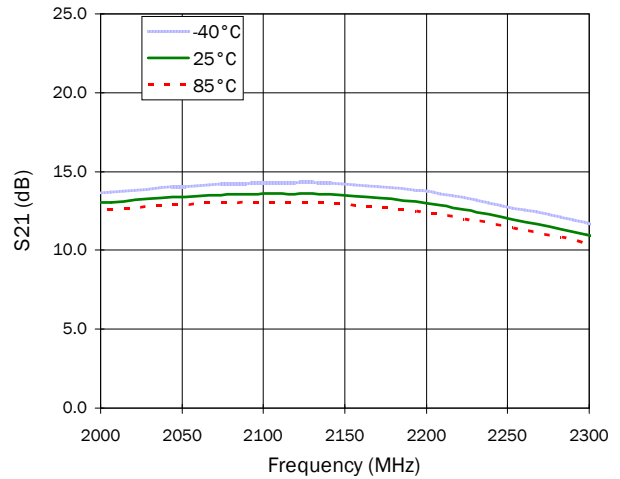

### S12 versus Frequency

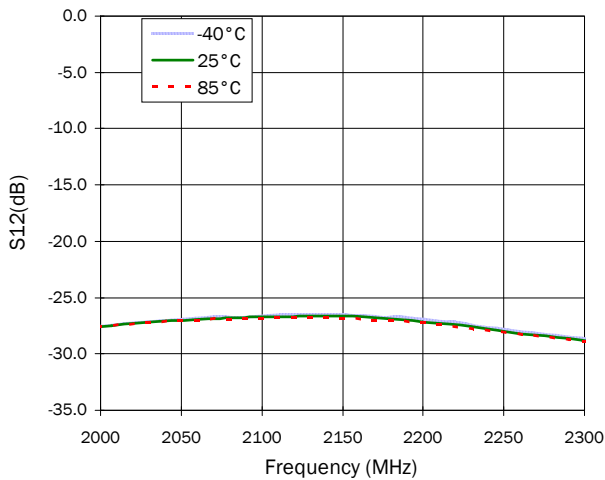

### S22 versus Frequency

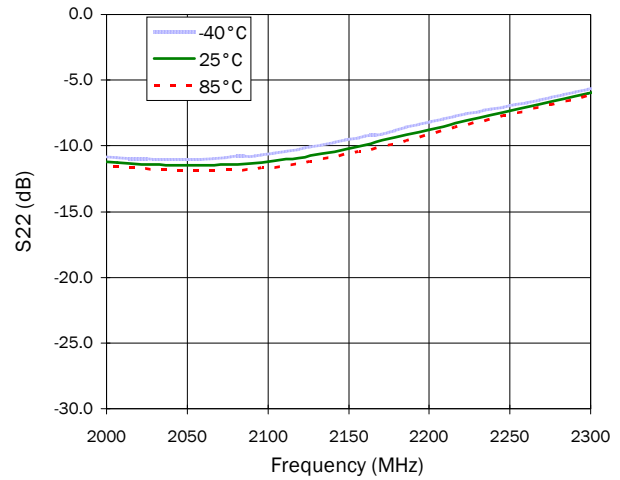



**Evaluation Board Layout and Bill of Materials**

850MHz to 910MHz Application Circuit ( $V_{CC}$  and  $V_{PC}=5.0V$ )

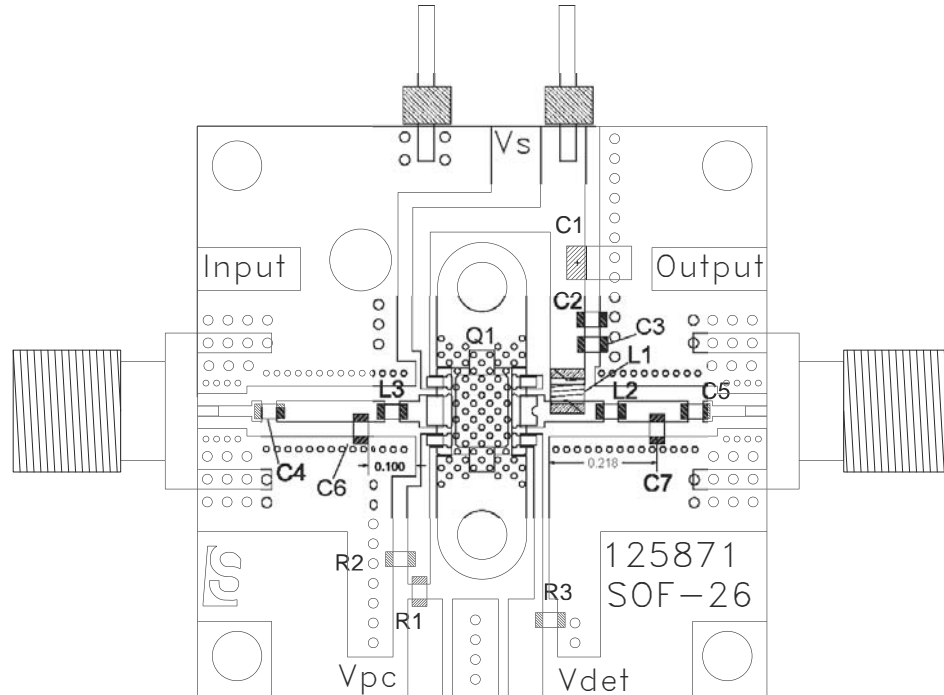

Bill of Materials

Q1	SPA-1526Z	
R1	825ohm 1%	
R2	4.32K ohm 1%	
R3	47k ohm	
C1	TAJA105K020R	1.0uF
C2	MCH185CN104KK	0.1uF
C3	MCH185A101JK	100pF
C4	MCH185A101JK	100pF
C5	MCH185A101JK	100pF
C6	MCH185A100JK	10pF
C7	MCH185A8R2JK	8.2pF
L1	0805HQ-48NX_BC	48nH Coil Craft
L2	LL1608FS-1N5S	1.5nH Toko
L3	LL1608FS-2N2S	2.7nH Toko
PCB	125871	

## Evaluation Board Layout and Bill of Materials

1930MHz to 1990MHz Application Circuit ( $V_{CC}$  and  $V_{PC}=5.0V$ )

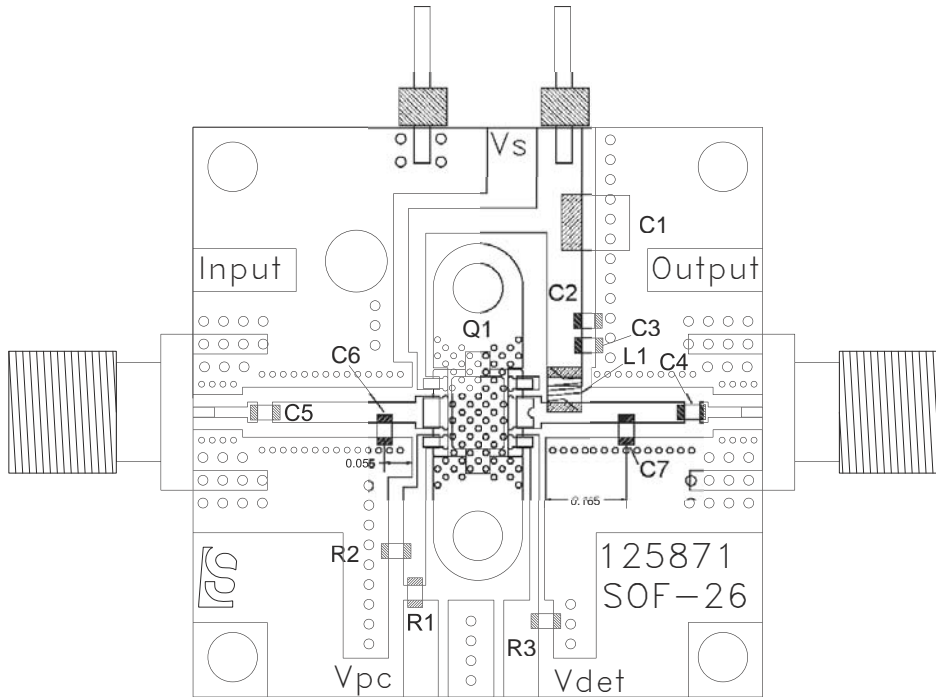

### Bill of Materials

Q1	SPA-1526Z	
R1	825ohm 1%	
R2	4.32K ohm 1%	
R3	47k ohm	
C1	TAJA106K020R	10.0uF
C2	MCH185CN104KK	0.1uF
C3	06035J100GBT	10pF AVX
C4	06035J100GBT	10pF AVX
C5	06035J100GBT	10pF AVX
C6	06035J3R9BBT	3.9pF AVX
C7	06035J3R0BBT	3.0pF AVX
L1	0805HQ-20NX_BC	20nH Coil Craft

PCB 125871

**Evaluation Board Layout and Bill of Materials**

2110MHz to 2170MHz Application Circuit ( $V_{CC}$  and  $V_{PC}=5.0V$ )

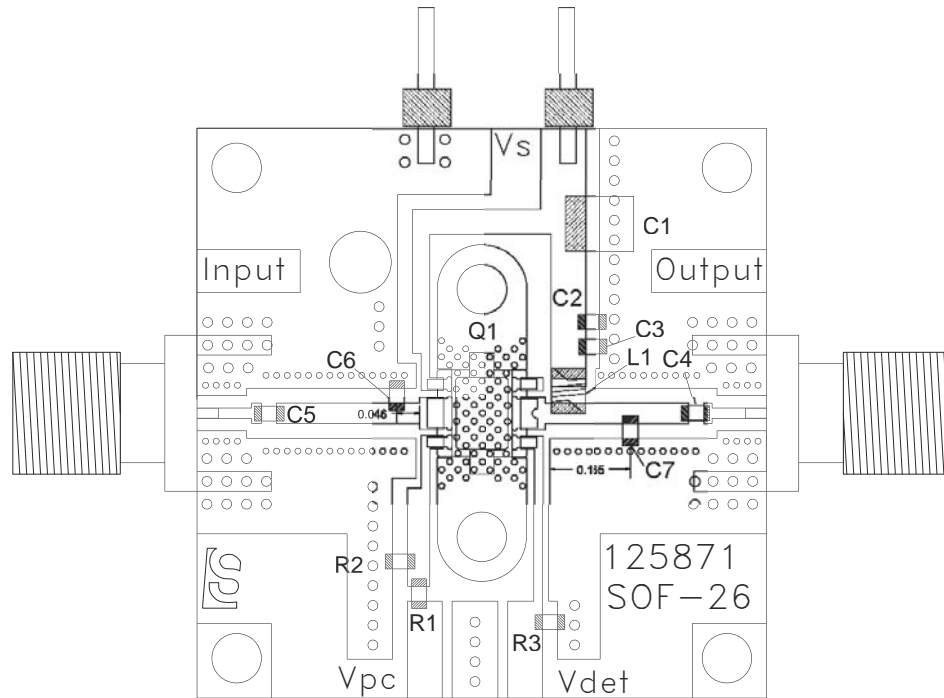

Bill of Materials

Q1	SPA-1526Z	
R1	825ohm 1%	
R2	4.32K ohm 1%	
R3	47k ohm	
C1	TAJA106K020R	10.0uF
C2	MCH185CN104KK	0.1uF
C3	06035J8R2BBT	8.2pF AVX
C4	06035J8R2BBT	8.2pF AVX
C5	06035J8R2BBT	8.2pF AVX
C6	06035J3R3BBT	3.3pF AVX
C7	06035J2R4BBT	2.4pF AVX
L1	0805HQ-20NX_BC	20nH Coil Craft
PCB	125871	

Pin	Function	Description
1	VBIAS	This is the supply voltage for the active bias circuit.
2	RF IN	This is the RF input pin and has a DC voltage present. An external DC block is required.
3	VPC	Power up/down control pin. The voltage on this pin should never exceed the voltage on pin 1 by more than 0.5V unless the supply current from pin 3 is limited <10mA.
4	VDET	This is the output port for the power detector. It samples the power at the input of the amplifier.
5	RF OUT/VCC	This is the RF output pin and DC connection to the collector.
6	NC	Not connected
GND	GND	These pins are DC-connected to the backside paddle. They provide good thermal connection to the backside paddle for hand soldering and rework. Many thermal and electrical GND vias are required as shown in the recommended land pattern.

### Suggested Pad Layout

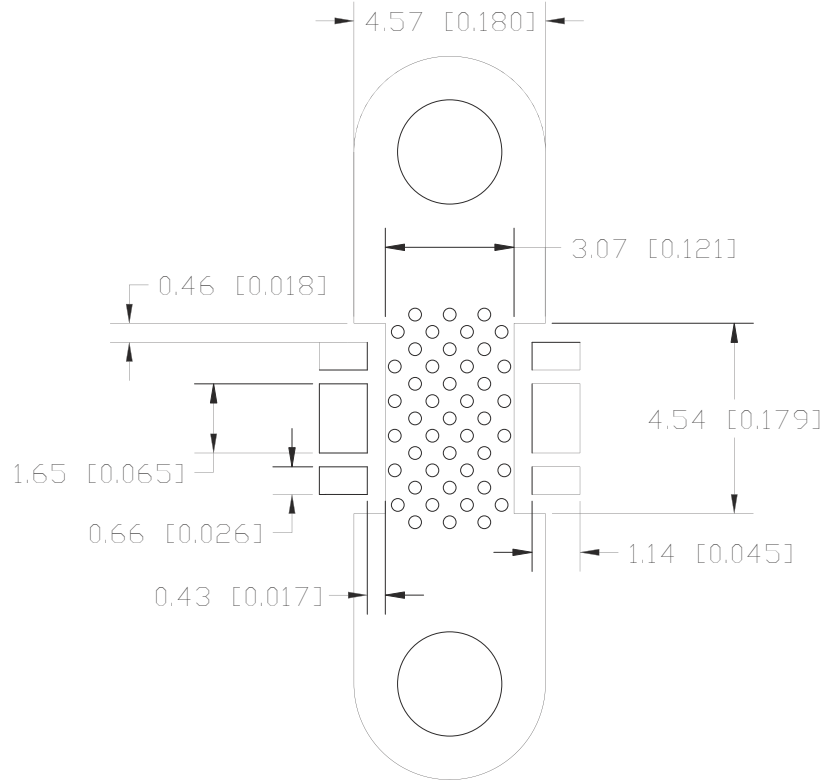

**Package Drawing**

Dimensions in inches (millimeters)

Refer to drawing posted at [www.rfmd.com](http://www.rfmd.com) for tolerances.

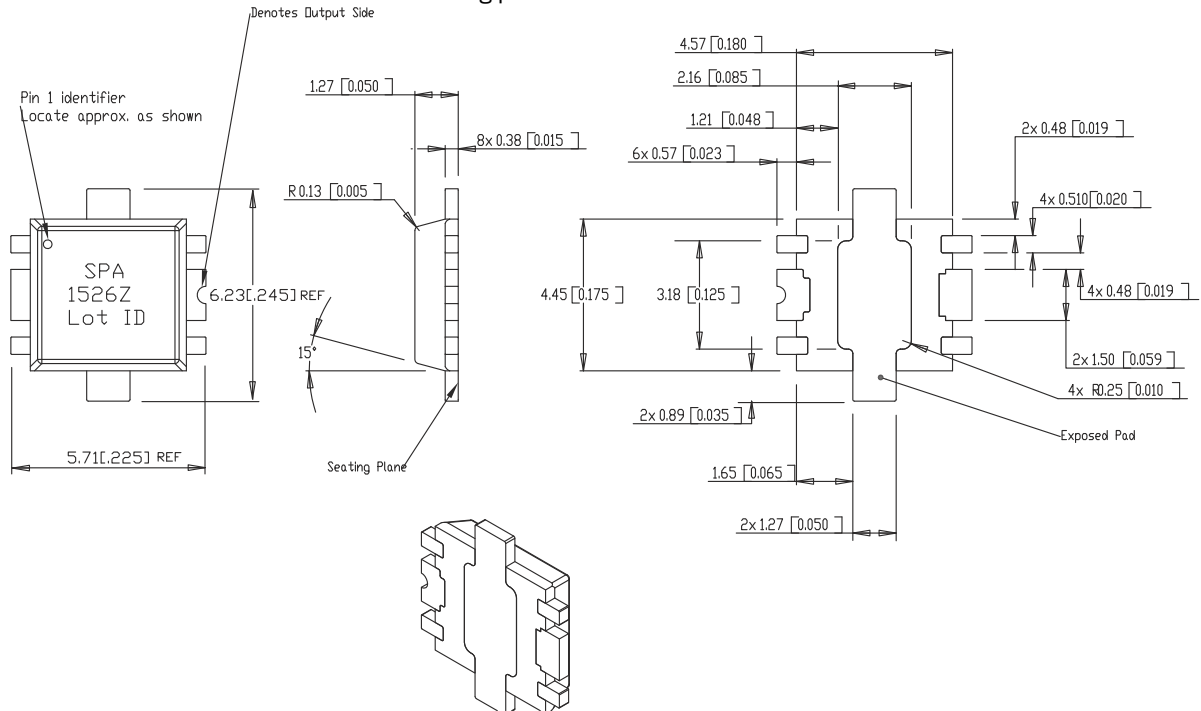

**Ordering Information**

Part Number	Description	Reel Size	Devices/Reel
SPA-1526Z	Lead Free, RoHS Compliant	7"	1000
SPA-1526Z-EVB1	850MHz to 910MHz Evaluation Board	N/A	N/A
SPA-1526Z-EVB2	1930MHz to 1960MHz Evaluation Board	N/A	N/A
SPA-1526Z-EVB3	2110MHz to 2170MHz Evaluation Board	N/A	N/A

**SPA-1526Z**

*Preliminary*

