

**3 Volt Voltage Variable Attenuator
25 dB, DC-2.5 GHz**

**AT-255
V7**

Features

- Single Voltage Control: 0 to -3 Volts
- 25 dB Attenuation Range at 0.9 GHz
- Low DC Power Consumption
- SOT-25 Plastic Package
- Tape and Reel Packaging Available

Description

M/A-COM's AT-255 is a GaAs MMIC voltage variable absorptive attenuator in a low cost SOT-25 surface mount plastic package. The AT-255 is ideally suited for use where variable attenuation, fine tuning, and very low power consumption are required.

Typical applications include radio, cellular, GPS equipment and automatic gain/level control circuits. The AT-255 is fabricated using a mature 1-micron GaAs MESFET process. The process features full chip passivation for increased performance and reliability.

Functional Schematic ¹

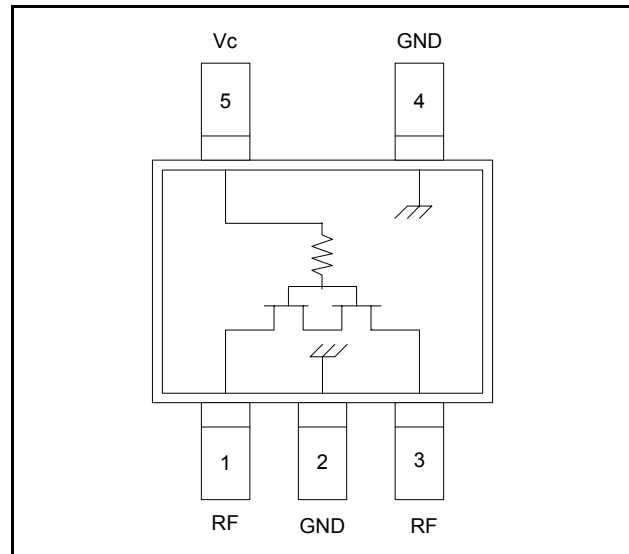

1. $V_c = -3\text{ V to }0\text{ V @ }25\text{ }\mu\text{A maximum.}$

Pin Configuration

Pin No.	Function	Pin No.	Function
1	RF Port	4	Ground
2	Ground	5	V_c
3	RF Port		

Ordering Information

Part Number	Package
AT-255	SOT-25 Plastic
AT-255TR	1000 piece reel

Note: Reference Application Note M513 for reel size information.

Absolute Maximum Ratings ²

Parameter	Absolute Maximum
Input Power	+21 dBm
Control Voltage V_c	-8 V to +0.5 V
Operating Temperature	-40°C to +85°C
Storage Temperature	-65°C to +150°C

2. Exceeding any one or combination of these limits may cause permanent damage to this device.

**3 Volt Voltage Variable Attenuator
25 dB, DC-2.5 GHz**

**AT-255
V7**

Electrical Specifications: $T_A = 25^\circ\text{C}$, $Z_0 = 50 \Omega$

Parameter	Test Conditions	Units	Min	Typ	Max
Insertion Loss ³	DC—2.0 GHz	dB	—	3.6	4.2
Attenuation	DC—1.0 GHz	dB	23	25	—
	1.0—2.0 GHz	dB	18	20	—
Flatness (Peak-to-Peak)	0.5—1.0 GHz	dB	—	± 7	± 10
	1.0—2.0 GHz	dB	—	± 5	± 8
VSWR	DC—2.0 GHz	Ratio	—	3:1	—
Trise, Tfall	10% to 90% RF, 90% to 10% RF	nS	—	10	—
Ton, Toff	50% Control to 90% RF, 50% Control to 10% RF	nS	—	20	—
Transients	In Band	mV	—	10	—

3. Insertion loss varies 0.003 dB/°C.

SOT-25

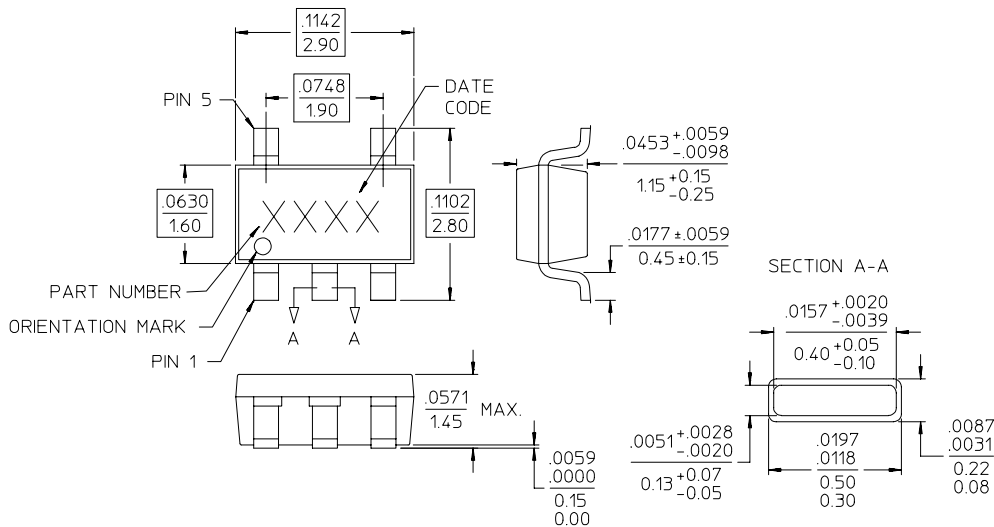

- NOTES: 1. REFERENCE JEDEC MO-178-AA FOR ADDITIONAL DIMENSIONAL AND TOLERANCE INFORMATION.
2. REFERENCE M538 APPLICATION NOTE FOR PCB FOOTPRINT INFORMATION.
3. ALL DIMENSIONS SHOWN AS INCHES/MM.

**3 Volt Voltage Variable Attenuator
25 dB, DC-2.5 GHz**

**AT-255
V7**

Typical Performance Curves

Relative Attenuation vs. Control Voltage

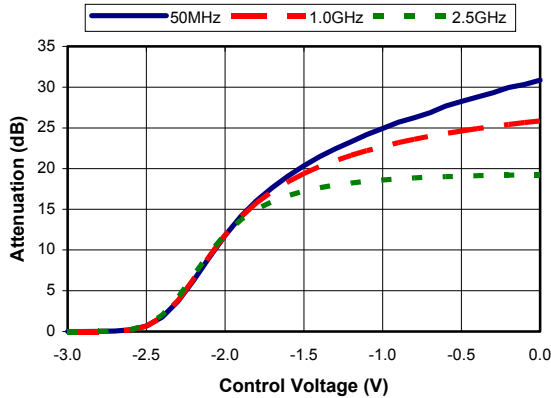

Insertion Loss vs. Frequency

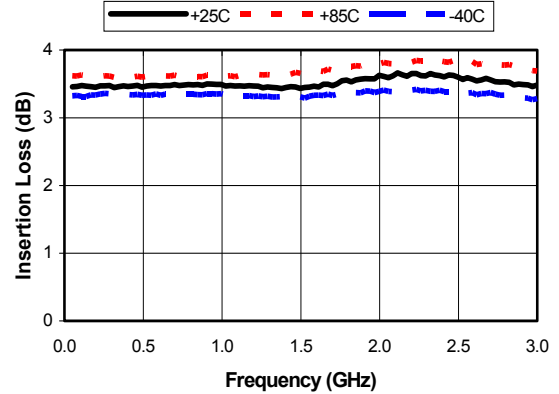

Maximum Relative Attenuation vs. Frequency

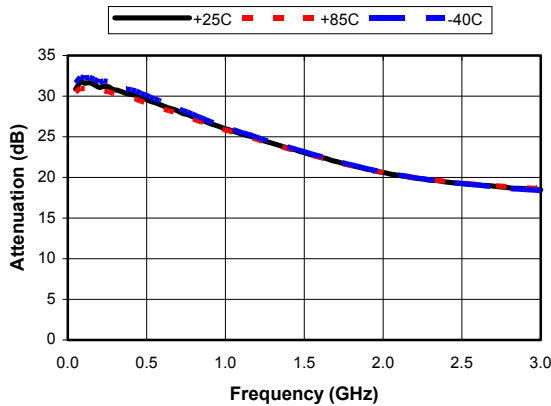

Return Loss vs. Control Voltage @ 900 MHz

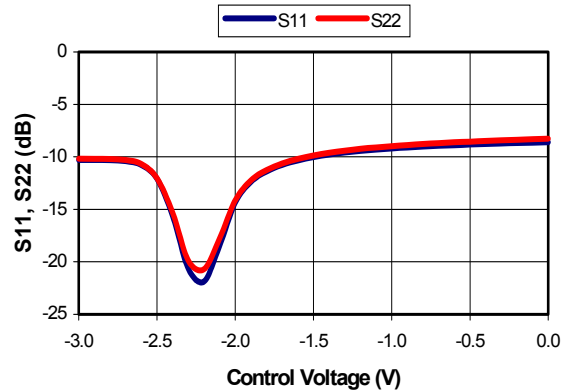

Input IP3 vs. Control Voltage

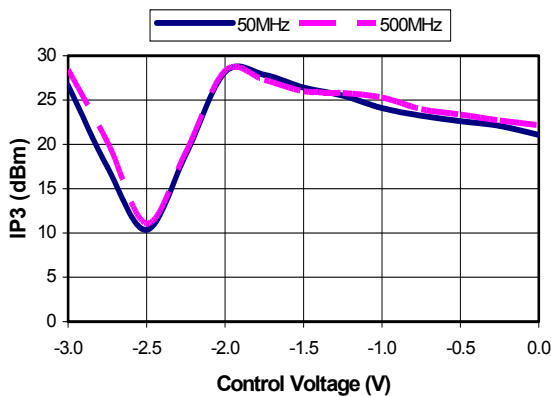

Input P1dB vs. Control Voltage

