



ULTRA-SMALL CERAMIC

Power Splitter/Combiner

SCN-2-11+

Mini-Circuits

2 Way-0° 50Ω 800 to 1175 MHz

FEATURES

- Isolation resistor, external 100 ohms
- Low insertion loss, 0.5 dB typ.
- Excellent amplitude unbalance, 0.1 dB typ.
- Excellent phase unbalance, 1.0 deg. typ.
- High isolation, 22 dB typ.
- Excellent power handling, 20W as splitter
- Small size, 0.12"X0.06"X0.035"
- ESD non-sensitive
- Temperature stable LTCC technology
- Wrap around terminations for excellent solderability
- Low cost
- Protected by US patent 6,967,544

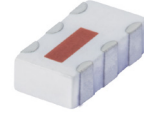

Generic photo used for illustration purposes only

CASE STYLE: FV1206-1

+RoHS Compliant

The +Suffix identifies RoHS Compliance. See our web site for RoHS Compliance methodologies and qualifications

APPLICATIONS

- GSM
- ISM
- Cellular

ELECTRICAL SPECIFICATIONS AT 25°C

Parameter	Frequency (MHz)	Min.	Typ.	Max.	Unit
Frequency Range		800		1175	MHz
Insertion Loss, above 3.0 dB	800-1175		0.5	0.8	dB
	875-1125		0.5	0.8	
Isolation	800-1175	15	20		dB
	875-1125	18	22		
Phase Unbalance	800-1175		1.0	3.0	Degree
	875-1125		1.0	3.0	
Amplitude Unbalance	800-1175		0.1	0.3	dB
	875-1125		0.1	0.3	
Return Loss (Input)	800-1175		16		dB
	875-1125		16		
Return Loss (Output)	800-1175		18		dB
	875-1125		20		

MAXIMUM RATINGS

Parameter	Ratings
Operating Temperature	-55°C to 100°C
Storage Temperature	-55°C to 100°C
Power Input (as a splitter)	20W* max.

*Derate linearly to 6W at 100°C ambient. Permanent damage may occur if any of these limits are exceeded.

ELECTRICAL SCHEMATIC

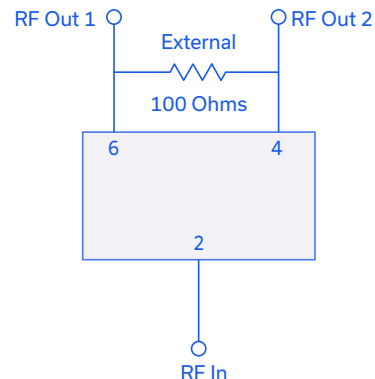

Mini-Circuits

www.minicircuits.com P.O. Box 350166, Brooklyn, NY 11235-0003 (718) 934-4500 sales@minicircuits.com

REV. J
ECO-010142
SCN-2-11+
ED-10710/2
AD/TD/CP/AM
211015
PAGE 1 OF 3



PIN CONNECTIONS

SUM PORT	2
PORT 1	6
PORT 2	4
GROUND	1,3,5
PORT 1-2	resistor external 100 ohms

PRODUCT MARKING: A

DEMO BOARD MCL P/N: TB-252
SUGGESTED PCB LAYOUT (PL-129)

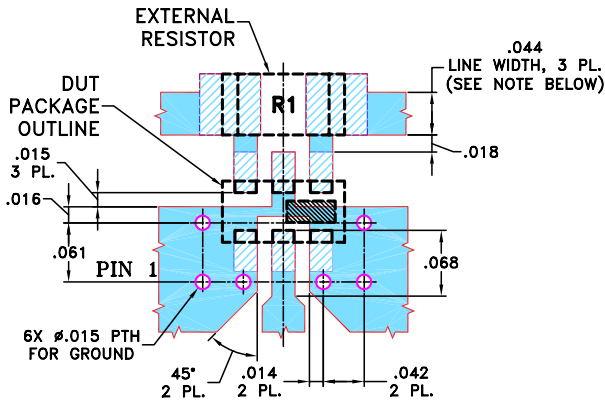

RESISTOR R1: 100 Ohm, 1206 SIZE

NOTES: 1. TRACE WIDTH IS SHOWN FOR ROGERS RO4350B WITH DIELECTRIC THICKNESS $0.020" \pm 0.0015"$; COPPER: 1/2 OZ. EACH SIDE. FOR OTHER MATERIALS TRACE WIDTH MAY NEED TO BE MODIFIED.

2. BOTTOM SIDE OF THE PCB IS CONTINUOUS GROUND PLANE.

- DENOTES PCB COPPER LAYOUT WITH SMOBC (SOLDER MASK OVER BARE COPPER)
- DENOTES COPPER LAND PATTERN FREE OF SOLDER MASK

OUTLINE DRAWING

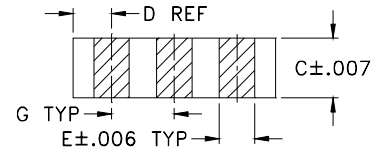
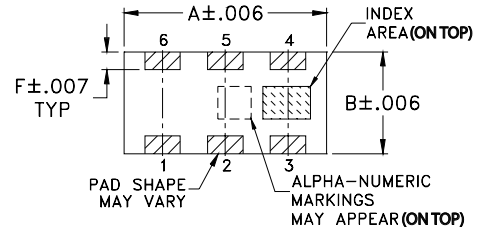

PCB Land Pattern

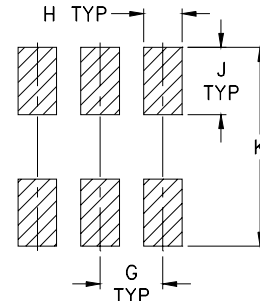

Suggested Layout,
Tolerance to be within ± 0.02

OUTLINE DIMENSIONS (Inches/mm)

A	B	C	D	E	F
.126	.063	.035	.024	.022	.011
3.20	1.60	0.89	0.61	0.56	0.28
G	H	J	K		wt
.039	.024	.042	.123		grams
0.99	0.61	1.07	3.12		.020



TYPICAL PERFORMANCE DATA

Frequency (MHz)	Total Loss ¹ (dB)		Amplitude Unbalance (dB)	Isolation (dB)	Phase Unbalance (deg.)	Return Loss (dB)		
	S-1	S-2				S	1	2
800.00	3.43	3.45	0.02	17.28	0.11	15.07	25.43	25.41
825.00	3.43	3.44	0.01	18.38	0.13	15.48	24.60	24.52
850.00	3.42	3.43	0.01	19.70	0.14	16.10	23.86	23.88
875.00	3.41	3.41	0.00	21.21	0.14	16.72	23.02	23.11
900.00	3.41	3.40	0.01	22.98	0.15	17.14	22.19	22.21
925.00	3.41	3.40	0.01	25.31	0.14	17.53	21.56	21.46
950.00	3.41	3.39	0.02	28.76	0.12	18.16	21.09	20.97
975.00	3.41	3.38	0.03	34.40	0.14	19.00	20.59	20.53
1000.00	3.41	3.37	0.04	42.99	0.16	19.65	20.02	19.96
1025.00	3.42	3.37	0.05	34.77	0.20	19.92	19.53	19.39
1050.00	3.43	3.37	0.06	28.77	0.23	20.08	19.20	19.01
1100.00	3.45	3.37	0.08	22.45	0.27	20.43	18.61	18.40
1125.00	3.46	3.37	0.09	20.49	0.31	20.22	18.29	18.00
1150.00	3.48	3.38	0.10	18.83	0.34	19.53	18.05	17.69
1175.00	3.51	3.40	0.11	17.34	0.36	18.61	17.90	17.54

1. Total Loss = Insertion Loss + 3dB splitter loss.

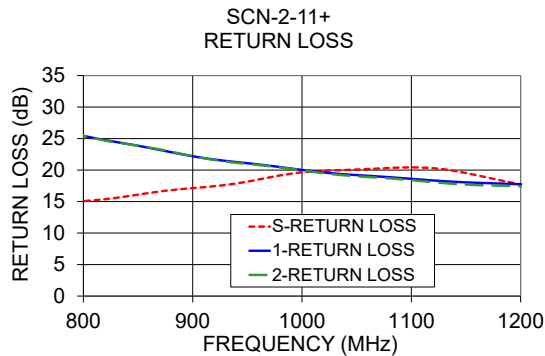
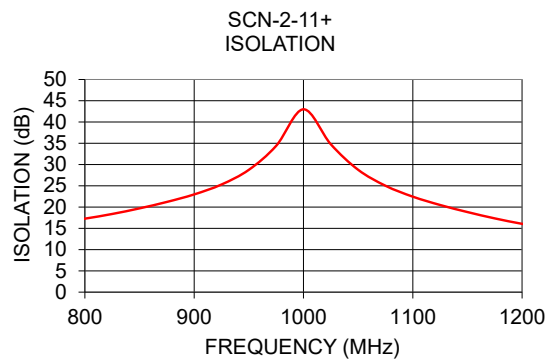
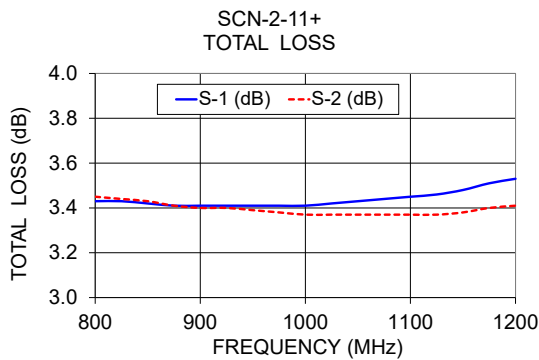

- NOTES**
- A. Performance and quality attributes and conditions not expressly stated in this specification document are intended to be excluded and do not form a part of this specification document.
 - B. Electrical specifications and performance data contained in this specification document are based on Mini-Circuit's applicable established test performance criteria and measurement instructions.
 - C. The parts covered by this specification document are subject to Mini-Circuits standard limited warranty and terms and conditions (collectively, "Standard Terms"); Purchasers of this part are entitled to the rights and benefits contained therein. For a full statement of the standard. Terms and the exclusive rights and remedies thereunder, please visit Mini-Circuits' website at www.minicircuits.com/MCLStore/terms.jsp



2 Way-0° Power Splitter/Combiner

SCN-2-11+

Typical Performance Data

TEST CONDITIONS: INPUT POWER = 0dBm @Temperature = +25°C

FREQ. (MHz)	TOTAL LOSS ¹ (dB)		AMP. UNBAL. (dB)	PHASE UNBAL. (deg.)	ISOLATION (dB)	VSWR (:1)		
	S-1	S-2				S	1	2
500	3.48	3.42	0.06	0.60	10.11	1.69	1.24	1.23
550	3.46	3.40	0.06	0.61	11.05	1.64	1.19	1.19
575	3.44	3.39	0.05	0.62	11.56	1.61	1.18	1.17
600	3.43	3.38	0.05	0.62	12.08	1.58	1.16	1.15
650	3.40	3.35	0.05	0.65	13.21	1.53	1.13	1.12
675	3.39	3.34	0.05	0.68	13.84	1.49	1.12	1.11
700	3.37	3.32	0.05	0.67	14.50	1.46	1.11	1.10
750	3.34	3.30	0.04	0.73	16.05	1.40	1.10	1.09
800	3.31	3.28	0.03	0.77	17.93	1.33	1.10	1.09
825	3.30	3.28	0.02	0.80	19.07	1.30	1.10	1.09
850	3.29	3.27	0.02	0.80	20.38	1.27	1.10	1.09
875	3.28	3.26	0.02	0.82	21.93	1.23	1.11	1.09
900	3.27	3.26	0.01	0.84	23.83	1.20	1.11	1.10
925	3.26	3.26	0.00	0.86	26.13	1.17	1.12	1.10
950	3.25	3.25	0.00	0.88	28.88	1.14	1.13	1.11
975	3.24	3.25	0.01	0.93	31.40	1.11	1.13	1.12
1000	3.24	3.26	0.02	0.97	31.08	1.09	1.14	1.12
1025	3.24	3.27	0.03	1.03	28.21	1.07	1.15	1.13
1050	3.24	3.28	0.04	1.06	25.31	1.08	1.16	1.14
1075	3.25	3.29	0.04	1.11	22.87	1.09	1.16	1.14
1100	3.26	3.31	0.05	1.14	20.88	1.12	1.17	1.15
1125	3.26	3.33	0.07	1.19	19.19	1.16	1.18	1.15
1150	3.28	3.35	0.07	1.26	17.73	1.20	1.19	1.16
1175	3.30	3.38	0.08	1.31	16.45	1.25	1.19	1.16
1200	3.32	3.41	0.09	1.38	15.30	1.30	1.20	1.17
1225	3.34	3.45	0.11	1.45	14.27	1.35	1.21	1.17
1250	3.37	3.49	0.12	1.55	13.33	1.41	1.21	1.18
1300	3.45	3.59	0.14	1.72	11.64	1.54	1.22	1.19
1325	3.50	3.65	0.15	1.81	10.89	1.62	1.23	1.19
1350	3.55	3.72	0.17	1.90	10.19	1.70	1.24	1.20
1400	3.68	3.87	0.19	2.13	8.91	1.88	1.25	1.21
1425	3.75	3.95	0.20	2.29	8.32	1.97	1.25	1.22
1450	3.84	4.05	0.21	2.42	7.76	2.08	1.26	1.23
1500	4.02	4.25	0.23	2.75	6.74	2.32	1.27	1.24
1525	4.13	4.37	0.24	2.90	6.26	2.45	1.28	1.25
1550	4.24	4.49	0.25	3.09	5.81	2.59	1.29	1.26

¹ Total Loss = Insertion Loss+ 3dB Splitter Loss



2 Way-0° Power Splitter/Combiner

SCN-2-11+

Typical Performance Data

TEST CONDITIONS: INPUT POWER = 0dBm @Temperature = -55°C

FREQ. (MHz)	TOTAL LOSS ¹ (dB)		AMP. UNBAL. (dB)	PHASE UNBAL. (deg.)	ISOLATION (dB)	VSWR (:1)		
	S-1	S-2				S	1	2
500	3.42	3.35	0.07	0.85	10.01	1.70	1.26	1.26
550	3.39	3.32	0.07	0.98	10.93	1.65	1.21	1.21
575	3.38	3.31	0.07	1.04	11.42	1.62	1.20	1.19
600	3.36	3.30	0.06	1.09	11.92	1.60	1.18	1.17
650	3.34	3.27	0.07	1.20	13.00	1.54	1.14	1.13
675	3.32	3.25	0.07	1.28	13.62	1.51	1.13	1.12
700	3.30	3.24	0.06	1.38	14.27	1.48	1.12	1.11
750	3.26	3.21	0.05	1.46	15.80	1.41	1.10	1.09
800	3.23	3.19	0.04	1.58	17.62	1.34	1.09	1.08
825	3.22	3.18	0.04	1.64	18.71	1.31	1.10	1.09
850	3.20	3.17	0.03	1.72	19.94	1.28	1.10	1.09
875	3.19	3.16	0.03	1.78	21.42	1.24	1.10	1.09
900	3.18	3.15	0.03	1.84	23.24	1.21	1.11	1.09
925	3.16	3.14	0.02	1.90	25.45	1.17	1.11	1.09
950	3.15	3.14	0.01	1.94	28.16	1.14	1.12	1.10
975	3.15	3.14	0.01	1.96	30.94	1.11	1.12	1.10
1000	3.15	3.14	0.01	2.00	31.55	1.08	1.13	1.11
1025	3.14	3.14	0.00	2.02	29.04	1.06	1.14	1.11
1050	3.14	3.15	0.01	2.07	26.08	1.06	1.15	1.12
1075	3.14	3.16	0.02	2.10	23.50	1.07	1.16	1.13
1100	3.15	3.17	0.02	2.15	21.39	1.11	1.16	1.13
1125	3.16	3.19	0.03	2.18	19.60	1.14	1.17	1.14
1150	3.17	3.21	0.04	2.20	18.08	1.19	1.18	1.14
1175	3.18	3.23	0.05	2.22	16.75	1.23	1.19	1.15
1200	3.20	3.25	0.05	2.23	15.59	1.28	1.20	1.15
1225	3.23	3.29	0.06	2.26	14.54	1.33	1.21	1.16
1250	3.25	3.32	0.07	2.27	13.61	1.38	1.21	1.17
1300	3.32	3.41	0.09	2.35	11.90	1.51	1.23	1.18
1325	3.36	3.46	0.10	2.35	11.12	1.58	1.23	1.19
1350	3.41	3.53	0.12	2.36	10.40	1.66	1.24	1.20
1400	3.53	3.67	0.14	2.32	9.06	1.84	1.25	1.21
1425	3.60	3.75	0.15	2.28	8.46	1.94	1.26	1.22
1450	3.67	3.83	0.16	2.26	7.90	2.04	1.27	1.23
1500	3.83	4.02	0.19	2.13	6.87	2.26	1.29	1.25
1525	3.93	4.13	0.20	2.11	6.38	2.39	1.30	1.27
1550	4.04	4.24	0.20	2.11	5.91	2.53	1.30	1.28

¹ Total Loss = Insertion Loss+ 3dB Splitter Loss

2 Way-0° Power Splitter/Combiner

SCN-2-11+

Typical Performance Data

TEST CONDITIONS: INPUT POWER = 0dBm @Temperature = +100°C

FREQ. (MHz)	TOTAL LOSS ¹ (dB)		AMP. UNBAL. (dB)	PHASE UNBAL. (deg.)	ISOLATION (dB)	VSWR (:1)		
	S-1	S-2				S	1	2
500	3.51	3.46	0.05	2.60	10.13	1.69	1.20	1.20
550	3.49	3.44	0.05	2.85	11.11	1.64	1.16	1.16
575	3.47	3.43	0.04	2.98	11.64	1.61	1.14	1.14
600	3.46	3.42	0.04	3.08	12.17	1.58	1.13	1.12
650	3.44	3.40	0.04	3.34	13.34	1.53	1.11	1.10
675	3.42	3.39	0.03	3.46	14.00	1.50	1.11	1.09
700	3.41	3.37	0.04	3.56	14.70	1.46	1.10	1.08
750	3.38	3.35	0.03	3.82	16.34	1.40	1.10	1.08
800	3.36	3.34	0.02	4.04	18.35	1.34	1.11	1.09
825	3.35	3.33	0.02	4.15	19.58	1.30	1.11	1.10
850	3.34	3.32	0.02	4.25	21.00	1.27	1.12	1.11
875	3.33	3.32	0.01	4.37	22.73	1.24	1.12	1.12
900	3.32	3.32	0.00	4.48	24.90	1.21	1.13	1.12
925	3.31	3.32	0.01	4.60	27.61	1.18	1.13	1.13
950	3.30	3.32	0.02	4.73	30.91	1.15	1.14	1.14
975	3.30	3.32	0.02	4.88	32.94	1.12	1.15	1.14
1000	3.30	3.33	0.03	5.01	30.55	1.10	1.15	1.15
1025	3.30	3.34	0.04	5.19	27.08	1.09	1.16	1.16
1050	3.30	3.35	0.05	5.33	24.22	1.09	1.17	1.16
1075	3.31	3.37	0.06	5.49	21.92	1.11	1.17	1.17
1100	3.32	3.39	0.07	5.62	20.05	1.14	1.18	1.17
1125	3.33	3.42	0.09	5.78	18.45	1.18	1.18	1.17
1150	3.35	3.44	0.09	5.94	17.08	1.23	1.19	1.18
1175	3.37	3.48	0.11	6.10	15.86	1.27	1.19	1.18
1200	3.39	3.51	0.12	6.29	14.76	1.33	1.20	1.19
1225	3.42	3.56	0.14	6.50	13.76	1.38	1.20	1.19
1250	3.45	3.61	0.16	6.71	12.87	1.44	1.20	1.19
1300	3.54	3.72	0.18	7.13	11.25	1.58	1.21	1.20
1325	3.59	3.79	0.20	7.34	10.53	1.66	1.22	1.20
1350	3.65	3.86	0.21	7.55	9.86	1.74	1.22	1.21
1400	3.79	4.03	0.24	8.07	8.62	1.92	1.23	1.21
1425	3.87	4.12	0.25	8.38	8.05	2.03	1.23	1.22
1450	3.96	4.22	0.26	8.63	7.51	2.14	1.23	1.22
1500	4.16	4.45	0.29	9.23	6.52	2.40	1.24	1.23
1525	4.28	4.57	0.29	9.56	6.06	2.54	1.25	1.24
1550	4.40	4.70	0.30	9.90	5.62	2.69	1.26	1.25

¹ Total Loss = Insertion Loss+ 3dB Splitter Loss

2 Way-0° Power Splitter/Combiner

SCN-2-11+

Typical Performance Curves

Total Loss

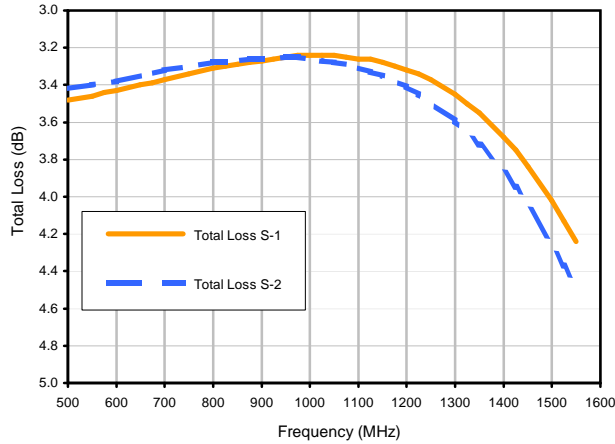

Total Loss S-1 vs. TEMPERATURE

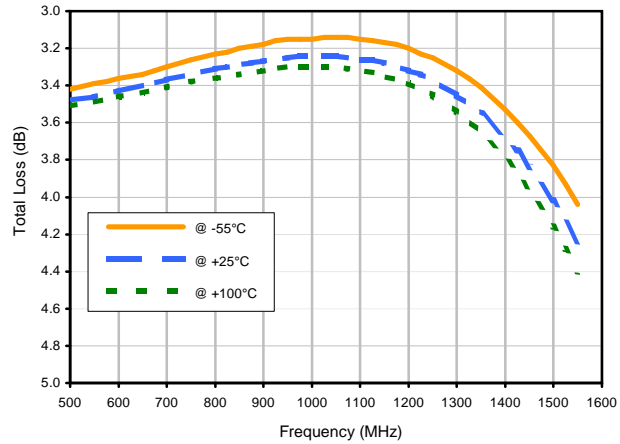

Amplitude Unbalance vs. TEMPERATURE

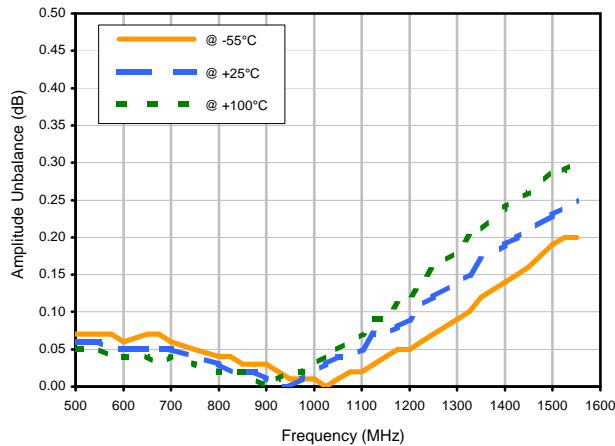

Phase Unbalance vs. TEMPERATURE

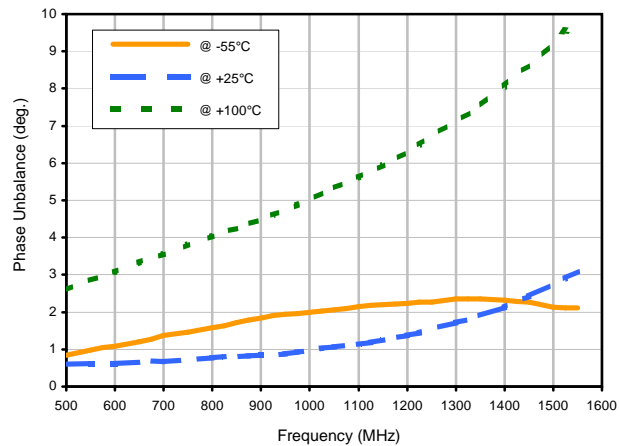

Isolation 1-2 vs. TEMPERATURE

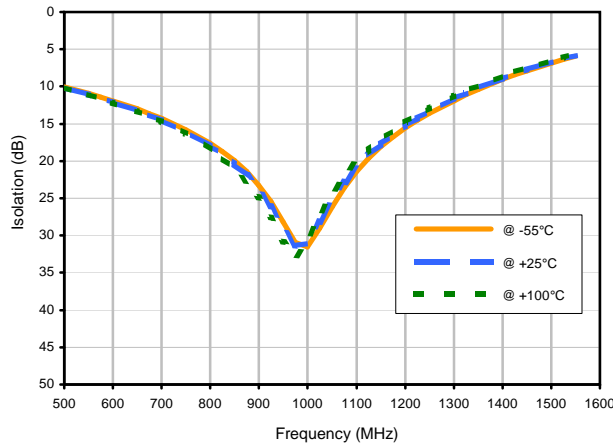

Typical Performance Curves

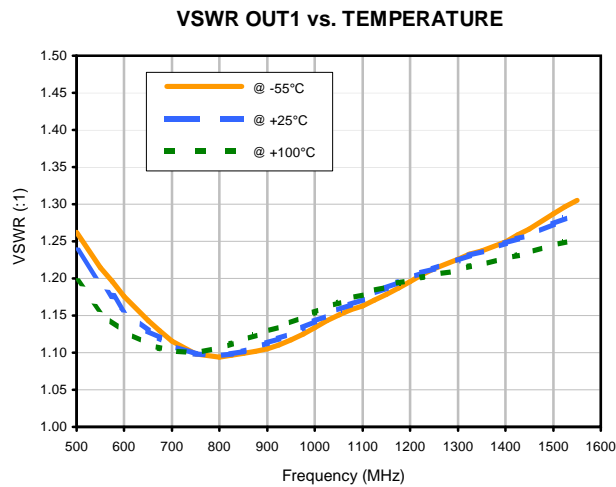
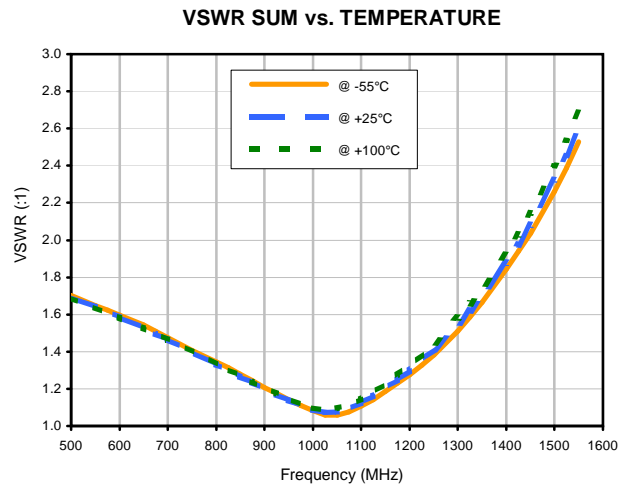
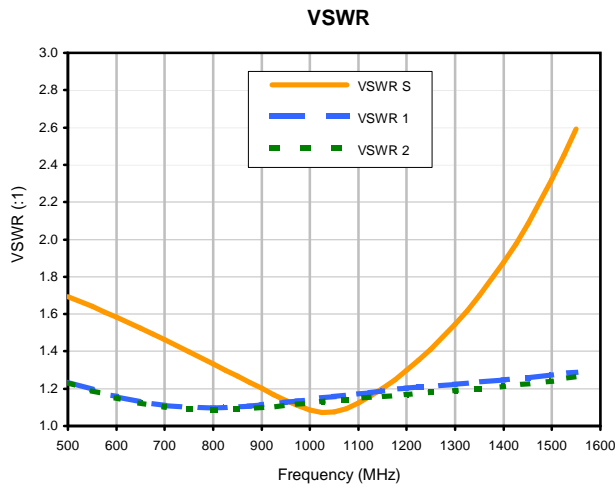

Outline Dimensions

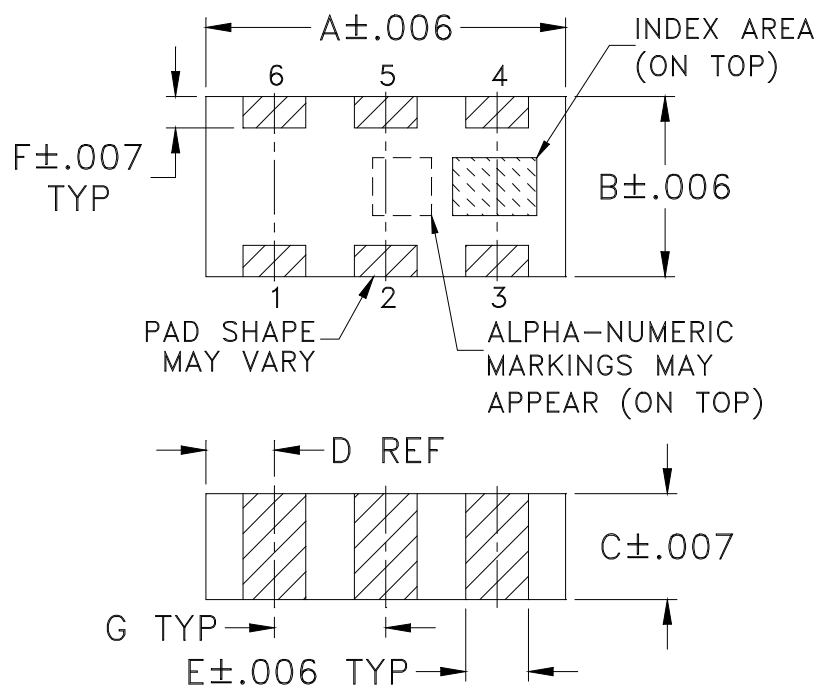

PCB Land Pattern

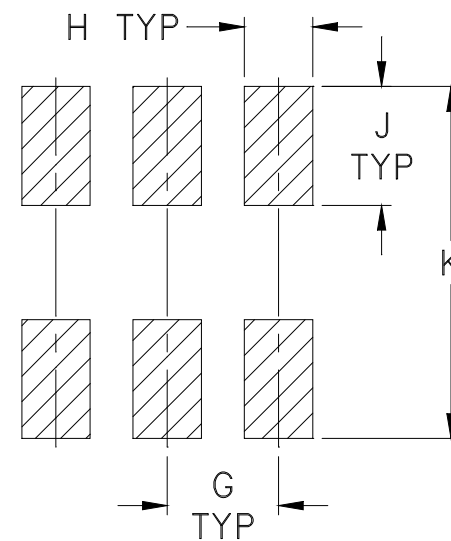

Suggested Layout,
Tolerance to be within $\pm.002$

CASE #	A	B	C	D	E	F	G	H	J	K	L	M	N	P	WT. GRAM
FV1206-1	.126 (3.20)	.063 (1.60)	.035 (0.89)	.024 (0.61)	.022 (0.56)	.011 (0.28)	.039 (0.99)	.024 (0.61)	.042 (1.07)	.123 (3.12)	--	--	--	--	.020

Dimensions are in inches (mm). Tolerances: 2 Pl. $\pm.01$; 3 Pl. $\pm.005$

Notes:

- Open style, ceramic base.
- Termination finish: **as shown below or indicated on Data Sheet.**
For RoHS Case Styles: Tin plate over Nickel plate. All models, (+) suffix.
For RoHS-5 Case Styles: Tin-Lead plate. All models, no (+) suffix.



P.O. Box 350166, Brooklyn, New York 11235-0003 (718) 934-4500 Fax (718) 332-4661 For detailed performance specs & shopping online see Mini-Circuits web site



The Design Engineers Search Engine Provides ACTUAL Data Instantly From MINI-CIRCUITS At: www.minicircuits.com

RF/IF MICROWAVE COMPONENTS

Tape & Reel Packaging TR-F75

DEVICE ORIENTATION IN T&R

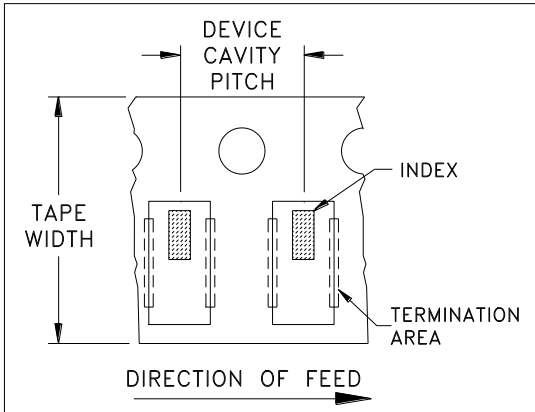

ILLUSTRATION 1

Applicable Case Styles

FV1206-1
FV1206-3

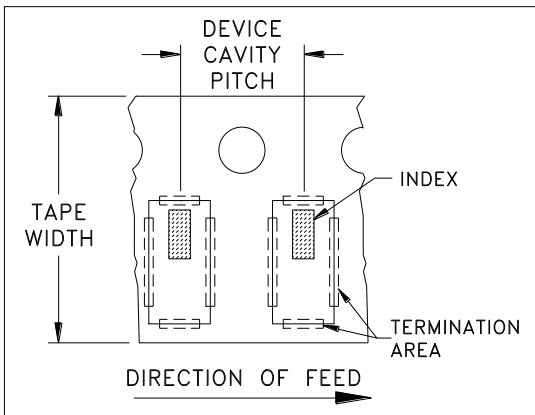

ILLUSTRATION 2

Applicable Case Styles

FV1206-4
FV1206-5
FV1206-6
FV1206-7
FV1206-9
JC0603C-1

Tape Width, mm	Device Cavity Pitch, mm	Reel Size, inches	Devices per Reel	
8	4	7	Small quantity standards (see note)	20
				50
				100
				200
				500
				1000
			Standard	3000

Note: Please consult individual model data sheet to determine device per reel availability.

Mini-Circuits carrier tape materials provide protection from ESD (Electro-Static Discharge) during handling and transportation. Tapes are static dissipative and comply with industry standards EIA-481/EIA-541.

Go to: www.minicircuits.com/pages/pdfs/tape.pdf



INTERNET <http://www.minicircuits.com>
P.O. Box 350166, Brooklyn, New York 11235-0003 (718) 934-4500 Fax (718) 332-4661
Distribution Centers NORTH AMERICA 800-654-7949 • 417-335-5935 • Fax 417-335-5945 • EUROPE 44-1252-832600 • Fax 44-1252-837010
Mini-Circuits ISO 9001 & ISO 14001 Certified

THIRD ANGLE PROJECTION

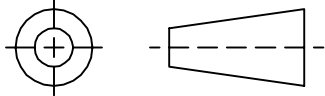

REVISIONS

REV	ECN No.	DESCRIPTION	DATE	DR	AUTH
A	M86650	UPDATED NOTE 2	04/18/03	GF	DJ
B	M86880	CHANGED APPEARANCE	05/05/03	IL	ABD
C	M91639	REMOVED NOTE 2, UPDATED DIMENSIONS	04/14/04	AV	DJ
D	M102713	ADDED "...WITH SMOBC"	01/16/06	GF	IL

**SUGGESTED MOUNTING CONFIGURATION
FOR FV1206-1 CASE STYLE, "pa" PIN CONNECTION.**

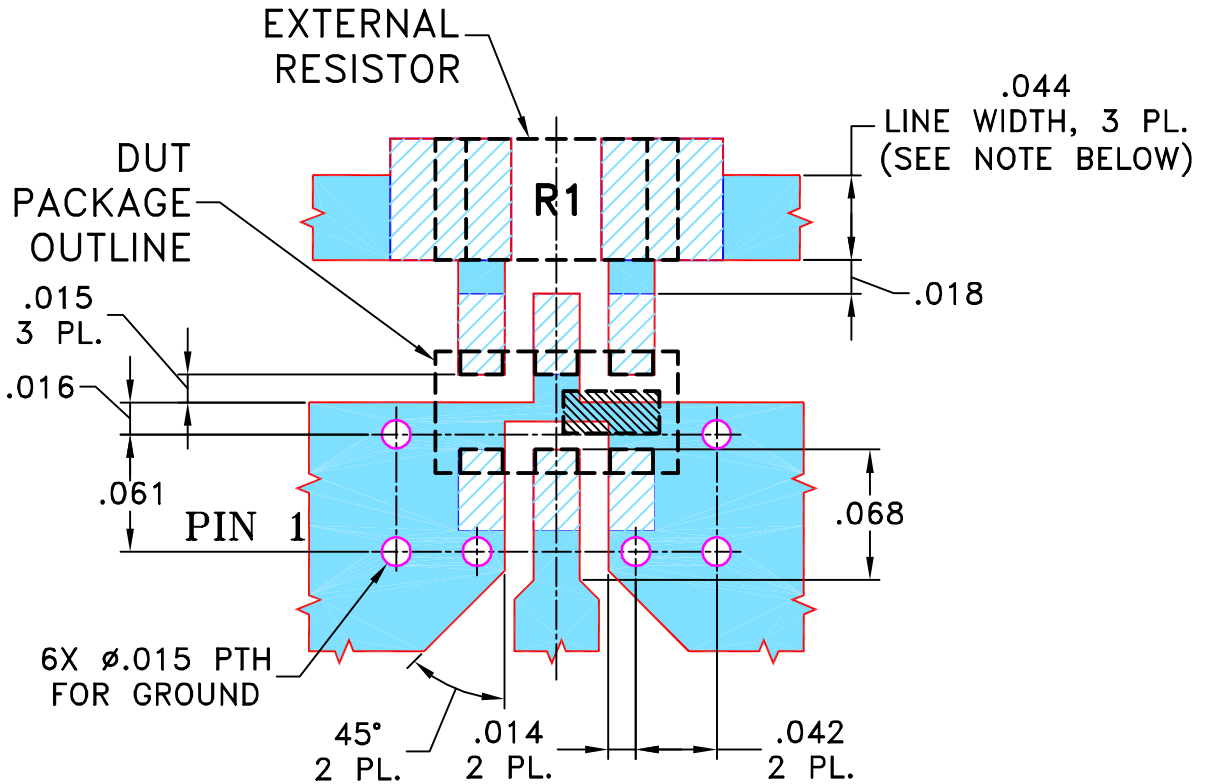

RESISTOR R1: 100 Ohm, 1206 SIZE

NOTES: 1. TRACE WIDTH IS SHOWN FOR ROGERS R04350B WITH DIELECTRIC THICKNESS 0.020" ± 0.0015"; COPPER: 1/2 OZ. EACH SIDE. FOR OTHER MATERIALS TRACE WIDTH MAY NEED TO BE MODIFIED.

2. BOTTOM SIDE OF THE PCB IS CONTINUOUS GROUND PLANE.

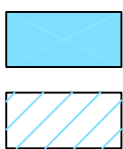

DENOTES PCB COPPER LAYOUT WITH SMOBC (SOLDER MASK OVER BARE COPPER)

DENOTES COPPER LAND PATTERN FREE OF SOLDER MASK

UNLESS OTHERWISE SPECIFIED	INITIALS		DATE
DIMENSIONS ARE IN INCHES TOLERANCES ON: 2 PL DECIMALS ± 3 PL DECIMALS ± .005 ANGLES ± FRACTIONS ±	DRAWN	GF	04/11/03
	CHECKED	IL	04/15/03
	APPROVED	ABD	04/15/03



Mini-Circuits®

13 Neptune Avenue
Brooklyn NY 11235

PL, pa, FV1206-1, SCN, TB-252

Mini-Circuits®
THIS DOCUMENT AND ITS CONTENTS ARE THE PROPERTY OF MINI-CIRCUITS. EXCEPT FOR USE EXPRESSLY GRANTED, IN WRITING, TO ITS VENDORS, VENDEE AND THE UNITED STATES GOVERNMENT, MINI-CIRCUITS RESERVES ALL PROPRIETARY DESIGN, USE, MANUFACTURING AND REPRODUCTION RIGHTS THERETO. THESE CONTENTS SHALL NOT BE USED, DUPLICATED OR DISCLOSED TO ANY OUTSIDE PARTY, IN WHOLE OR IN PART, WITHOUT WRITTEN PERMISSION OF MINI-CIRCUITS.

SIZE	CODE IDENT	DRAWING NO:	REV:
A	15542	98-PL-129	D
FILE:	98PL129	SCALE:	10:1
		SHEET:	1 OF 1

Evaluation Board and Circuit

For Pin Connections refer to Data Sheet of the DUT

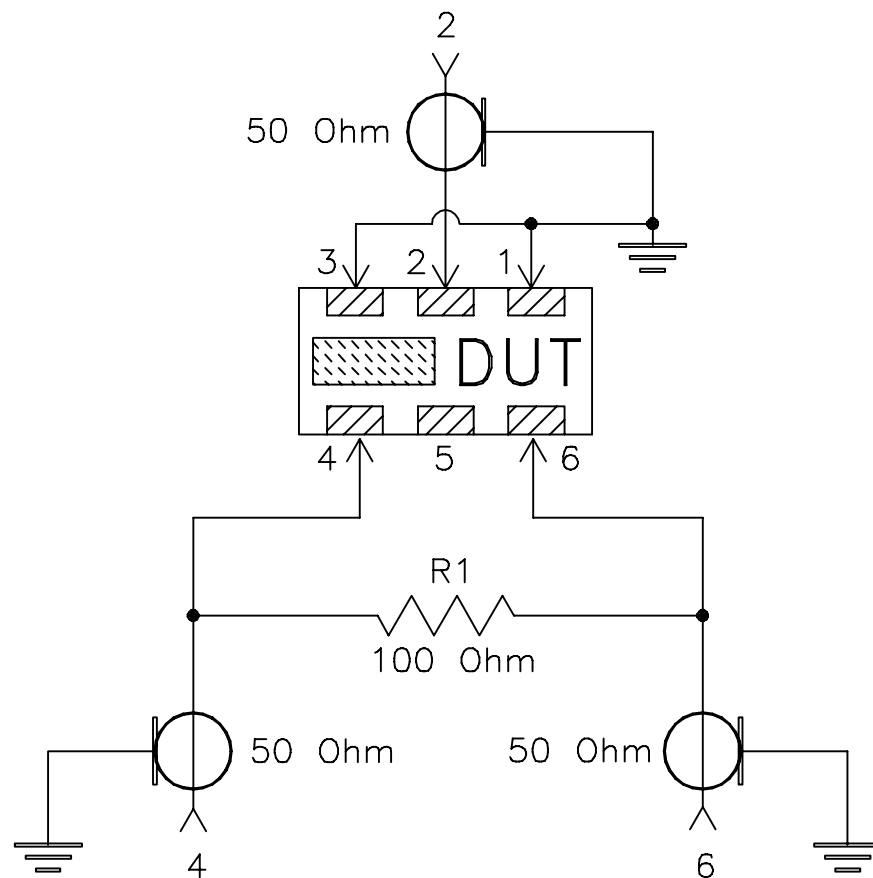
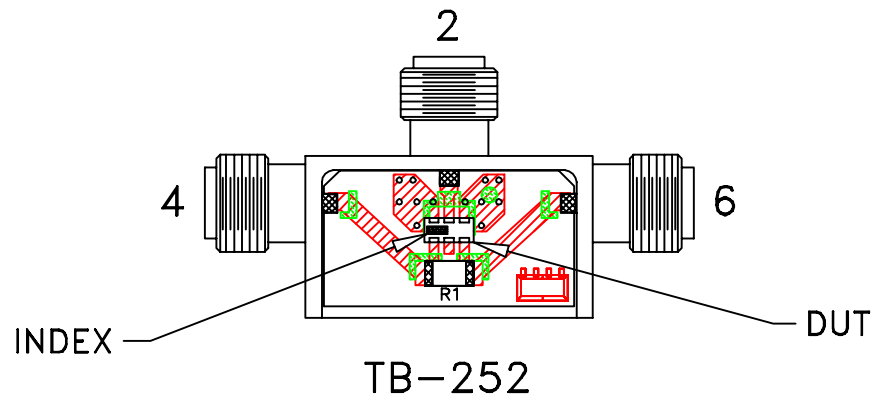

Schematic Diagram

Notes:

1. SMA Female connectors.
2. PCB Material: Rogers R04350 or equivalent, Dielectric Constant=3.5, Thickness=.020 inch.

 Mini-Circuits®

All Mini-Circuits products are manufactured under exacting quality assurance and control standards, and are capable of meeting published specifications after being subjected to any or all of the following physical and environmental test.

Specification	Test/Inspection Condition	Reference/Spec
Operating Temperature	-55° to 100°C Ambient Environment	Individual Model Data Sheet
Storage Temperature	-55° to 100° C Ambient Environment	Individual Model Data Sheet
Humidity	90 to 95% RH, 240 hours, 50°C	MIL-STD-202, Method 103, Condition A, Except 50°C and end-point electrical test done within 12 hours
Solder Reflow Heat	Sn-Pb Eutetic Process: 225°C peak Pb-Free Process 245° - 250°C peak	J-STD-020, Table 4-1, 4-2 and 5-2, Figure 5-1
Solderability	10X Magnification	J-STD-002, Para 4.2.5, Test S, 95% Coverage
Vibration (High Frequency)	20g peak, 10-2000 Hz, 12 times in each of three perpendicular directions (total 36)	MIL-STD-202, Method 204, Condition D
Mechanical Shock	50g, 11 ms, 1/2-sine, 18 shocks: 3 each direction, each of 3 axes	MIL-STD-202, Method 213, Condition A