

Frequency Mixer

SKY-60+

Level 7 (LO Power +7 dBm) 2500 to 6000 MHz



Generic photo used for illustration purposes only
CASE STYLE: BJ398

+RoHS Compliant

The +Suffix identifies RoHS Compliance. See our web site for RoHS Compliance methodologies and qualifications

Maximum Ratings

Operating Temperature	-40°C to 85°C
Storage Temperature	-55°C to 100°C
RF Power	200mW
IF Current	40mA

Permanent damage may occur if any of these limits are exceeded.

Pin Connections

LO	1
RF	5
IF	7
GROUND	2,3,4,6,8

Outline Drawing

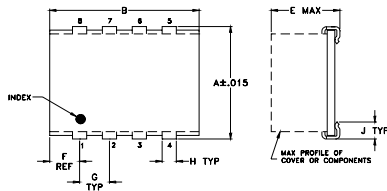

PCB Land Pattern

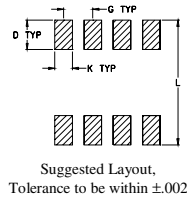

Outline Dimensions (inch/mm)

A	B	C	D	E	F	G
.305	.390	--	.100	.105	.045	.100
7.75	9.91	--	2.54	2.67	1.14	2.54

H	J	K	L	wt
.047	.065	.065	.325	grams
1.19	1.65	1.65	8.26	0.20

Demo Board MCL P/N: TB-11 Suggested PCB Layout (PL-056)

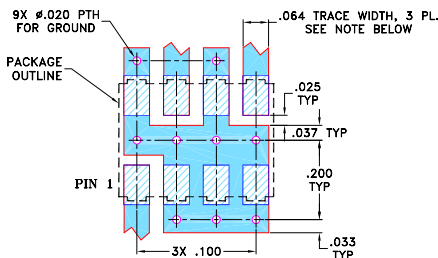

NOTES:

- TRACE WIDTH IS SHOWN FOR ROGERS RO4350B WITH DIELECTRIC THICKNESS .030" ± .002". COPPER: 1/2 OZ. EACH SIDE. FOR OTHER MATERIALS TRACE WIDTH MAY NEED TO BE MODIFIED.
- BOTTOM SIDE OF THE PCB IS CONTINUOUS GROUND PLANE.
 - DENOTES PCB COPPER LAYOUT WITH SMOBC (SOLDER MASK OVER BARE COPPER)
 - DENOTES COPPER LAND PATTERN FREE OF SOLDER MASK

Notes

- Performance and quality attributes and conditions not expressly stated in this specification document are intended to be excluded and do not form a part of this specification document.
- Electrical specifications and performance data contained in this specification document are based on Mini-Circuit's applicable established test performance criteria and measurement instructions.
- The parts covered by this specification document are subject to Mini-Circuits standard limited warranty and terms and conditions (collectively, "Standard Terms"); Purchasers of this part are entitled to the rights and benefits contained therein. For a full statement of the Standard Terms and the exclusive rights and remedies thereunder, please visit Mini-Circuits' website at www.minicircuits.com/MCLStore/terms.jsp

Features

- wide bandwidth, 2500 to 6000 MHz.
- low conversion loss, 6.2 dB typ.
- good L-R isolation, 28 dB typ.
- J-leads for strain relief

Applications

- line of sight links
- fixed satellite

Electrical Specifications

FREQUENCY (MHz)		CONVERSION LOSS (dB)			LO-RF ISOLATION (dB)		LO-IF ISOLATION (dB)		IP3 at center band (dBm)
LO/RF	IF	Mid-Band	Total Range	Max.	Typ.	Min.	Typ.	Min.	Typ.
f_L-f_U		\bar{X}	σ						
2500-6000	DC-1500	6.2	.20	9.7	28	17	14	8	11

1 dB COMP.: +1 dBm typ.

Typical Performance Data

Frequency (MHz)		Conversion Loss (dB)	Isolation L-R (dB)	Isolation L-I (dB)	VSWR RF Port (:1)	VSWR LO Port (:1)
RF	LO	LO +7dBm	LO +7dBm	LO +7dBm	LO +7dBm	LO +7dBm
2500.00	2530.00	6.39	28.60	17.65	3.17	4.99
2698.11	2728.11	6.24	26.41	16.56	3.12	4.03
2896.23	2926.23	6.11	23.87	14.61	3.10	3.30
3000.00	3030.00	6.13	22.62	13.96	2.94	3.18
3292.45	3322.45	6.12	21.77	12.75	2.22	2.85
3490.57	3520.57	6.26	22.01	12.06	1.80	2.67
3688.68	3718.68	6.70	22.43	11.80	1.59	2.80
3886.79	3916.79	6.59	26.67	12.03	1.50	2.61
3952.83	3982.83	6.54	27.93	12.54	1.54	2.57
4000.00	4030.00	6.54	27.51	13.08	1.61	2.74
4283.02	4253.02	6.56	33.35	15.58	2.00	3.01
4547.17	4517.17	6.66	35.36	17.59	2.32	3.07
4811.32	4781.32	6.83	31.67	19.88	2.56	2.88
4943.40	4913.40	6.96	30.01	21.24	2.59	2.94
5000.00	4970.00	6.95	30.27	21.94	2.60	2.95
5273.58	5243.58	7.16	28.84	24.64	2.37	3.75
5537.74	5507.74	7.37	27.52	27.13	2.29	4.09
5801.89	5771.89	7.51	26.80	29.17	2.45	5.12
5867.92	5837.92	7.52	26.60	29.78	2.66	5.33
6000.00	5970.00	7.71	26.91	30.39	2.85	5.87

Electrical Schematic

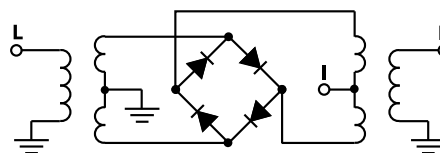

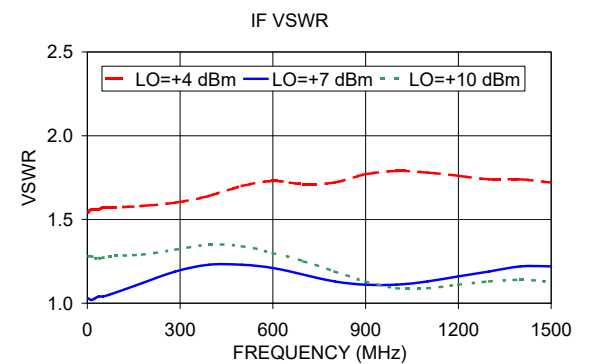
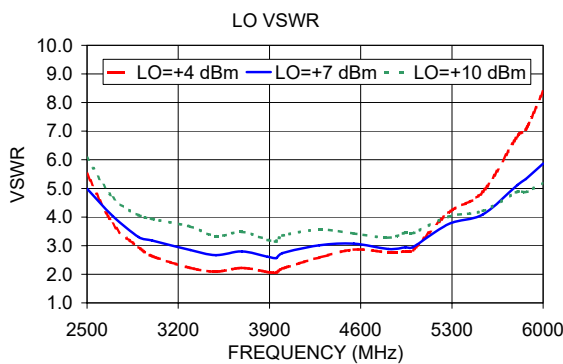
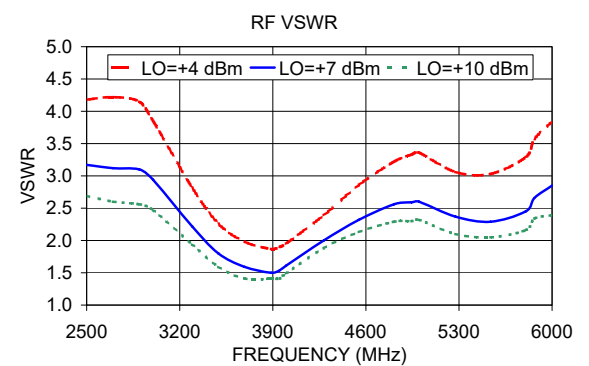
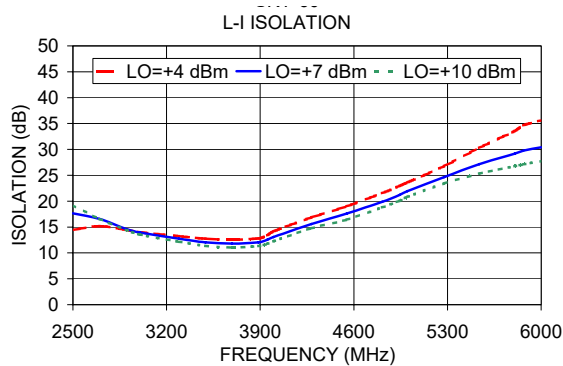
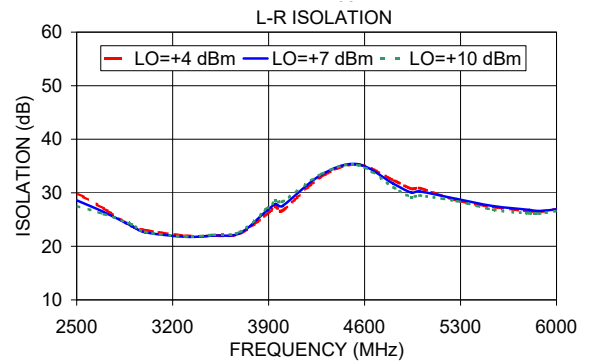
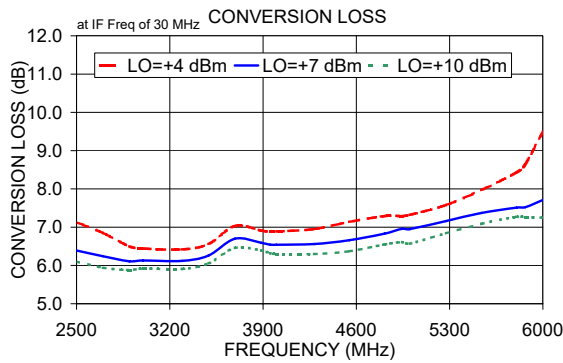

Notes

- A. Performance and quality attributes and conditions not expressly stated in this specification document are intended to be excluded and do not form a part of this specification document.
- B. Electrical specifications and performance data contained in this specification document are based on Mini-Circuit's applicable established test performance criteria and measurement instructions.
- C. The parts covered by this specification document are subject to Mini-Circuits standard limited warranty and terms and conditions (collectively, "Standard Terms"); Purchasers of this part are entitled to the rights and benefits contained therein. For a full statement of the Standard Terms and the exclusive rights and remedies thereunder, please visit Mini-Circuits' website at www.minicircuits.com/MCLStore/terms.jsp



Frequency Mixer

SKY-60+

Typical Performance Data

RF (IN) (MHz)	LO (MHz)	CONVERSION LOSS IF FIXED @IF(OUT)=30MHz (dB)			RF (IN) (MHz)	LO (MHz)	IP3 INPUT (dBm)			RF (IN) (MHz)	LO (MHz)	COMPRESSION @RF IN=+1dBm (dB)		
		@LO (dBm)					@LO (dBm)					@LO (dBm)		
		+4	+7	+10			+4	+7	+10			+4	+7	+10
1570.0	1600.0	15.74	10.60	8.11	1570.0	1600.0	-0.04	8.59	9.59	1570.0	1600.0	-2.68	0.24	1.01
1730.5	1760.5	11.92	8.02	6.82	1730.5	1760.5	2.90	8.27	8.17	1730.5	1760.5	-0.61	1.42	1.34
1891.0	1921.0	8.26	6.57	6.09	1891.0	1921.0	8.54	7.97	7.12	1891.0	1921.0	1.51	1.86	1.63
2051.5	2081.5	6.87	6.03	5.75	2051.5	2081.5	8.09	8.45	9.31	2051.5	2081.5	1.96	1.89	1.73
2212.0	2242.0	6.04	5.41	5.22	2212.0	2242.0	9.09	8.50	8.45	2212.0	2242.0	2.10	2.00	1.87
2372.5	2402.5	5.59	5.19	5.02	2372.5	2402.5	10.71	10.54	10.01	2372.5	2402.5	1.93	1.78	1.74
2533.0	2563.0	5.62	5.20	5.01	2533.0	2563.0	10.64	11.86	10.44	2533.0	2563.0	1.81	1.63	1.58
2693.5	2723.5	5.56	5.30	5.16	2693.5	2723.5	11.51	10.89	9.04	2693.5	2723.5	1.67	1.42	1.37
2854.0	2884.0	5.64	5.41	5.32	2854.0	2884.0	11.22	10.67	9.32	2854.0	2884.0	1.48	1.21	1.15
3014.5	3044.5	5.95	5.69	5.57	3014.5	3044.5	9.62	10.42	10.54	3014.5	3044.5	1.32	1.10	1.07
3175.0	3205.0	6.02	5.76	5.63	3175.0	3205.0	7.68	8.13	7.44	3175.0	3205.0	1.16	1.05	1.07
3335.5	3365.5	6.16	5.81	5.61	3335.5	3365.5	9.12	8.12	7.96	3335.5	3365.5	0.89	0.82	0.87
3496.0	3526.0	6.54	6.15	5.88	3496.0	3526.0	9.23	9.03	8.25	3496.0	3526.0	0.72	0.60	0.62
3656.5	3686.5	6.37	6.05	5.86	3656.5	3686.5	8.68	9.74	9.79	3656.5	3686.5	0.74	0.58	0.53
3817.0	3847.0	6.44	6.13	5.93	3817.0	3847.0	9.40	11.08	11.89	3817.0	3847.0	0.60	0.42	0.37
3977.5	4007.5	6.47	6.18	6.00	3977.5	4007.5	12.24	16.10	17.81	3977.5	4007.5	0.64	0.39	0.32
4138.0	4168.0	6.25	6.01	5.90	4138.0	4168.0	10.52	14.76	17.69	4138.0	4168.0	0.73	0.36	0.26
4298.5	4328.5	6.54	6.23	6.08	4298.5	4328.5	9.62	11.93	14.94	4298.5	4328.5	0.62	0.31	0.21
4459.0	4489.0	6.99	6.55	6.31	4459.0	4489.0	10.02	11.13	12.59	4459.0	4489.0	0.66	0.40	0.28
4619.5	4649.5	7.14	6.69	6.41	4619.5	4649.5	9.60	10.17	12.03	4619.5	4649.5	0.54	0.33	0.29
4780.0	4810.0	7.30	6.95	6.69	4780.0	4810.0	9.26	9.95	11.26	4780.0	4810.0	0.41	0.13	0.11
4940.5	4970.5	6.83	6.58	6.46	4940.5	4970.5	9.44	11.94	14.57	4940.5	4970.5	0.76	0.30	0.13
5101.0	5131.0	6.35	6.03	5.97	5101.0	5131.0	9.70	10.68	11.55	5101.0	5131.0	1.16	0.68	0.42
5261.5	5291.5	6.80	6.30	6.18	5261.5	5291.5	8.78	9.54	10.89	5261.5	5291.5	1.90	1.54	1.17
5422.0	5452.0	8.26	7.42	7.00	5422.0	5452.0	12.88	20.11	12.48	5422.0	5452.0	1.28	1.19	1.07
5582.5	5612.5	8.15	7.31	6.88	5582.5	5612.5	8.71	10.11	9.56	5582.5	5612.5	0.97	0.89	0.89
5743.0	5773.0	7.82	6.99	6.62	5743.0	5773.0	6.36	8.03	7.92	5743.0	5773.0	1.15	0.88	0.84
5923.6	5953.6	7.39	6.54	6.25	5923.6	5953.6	5.33	7.42	7.29	5923.6	5953.6	1.30	0.88	0.79
6084.1	6114.1	7.10	6.26	6.02	6084.1	6114.1	5.01	7.36	7.52	6084.1	6114.1	1.46	0.98	0.80
6264.7	6294.7	6.81	6.00	5.79	6264.7	6294.7	5.15	7.71	7.99	6264.7	6294.7	1.30	0.86	0.71
6425.2	6455.2	6.58	5.81	5.65	6425.2	6455.2	6.68	9.23	9.15	6425.2	6455.2	1.28	0.88	0.72
6605.7	6635.7	6.62	5.89	5.70	6605.7	6635.7	7.41	10.27	10.24	6605.7	6635.7	1.29	0.90	0.81
6766.2	6796.2	6.56	6.00	5.82	6766.2	6796.2	7.57	9.48	9.16	6766.2	6796.2	1.12	0.86	0.84
6946.8	6976.8	6.67	6.16	6.02	6946.8	6976.8	8.17	10.74	10.44	6946.8	6976.8	0.93	0.71	0.68
7107.3	7137.3	6.82	6.37	6.27	7107.3	7137.3	10.34	14.04	14.20	7107.3	7137.3	0.78	0.56	0.54
7287.9	7317.9	7.40	7.02	6.91	7287.9	7317.9	9.40	11.05	10.39	7287.9	7317.9	0.71	0.60	0.60
7448.4	7478.4	7.63	7.23	7.16	7448.4	7478.4	10.79	11.90	11.01	7448.4	7478.4	0.56	0.50	0.52
7628.9	7658.9	8.50	8.02	7.86	7628.9	7658.9	12.67	13.99	11.95	7628.9	7658.9	0.47	0.48	0.56
7789.4	7819.4	9.49	9.06	8.91	7789.4	7819.4	12.31	14.16	12.53	7789.4	7819.4	0.46	0.50	0.63
7970.0	8000.0	10.67	10.25	10.14	7970.0	8000.0	11.98	13.96	12.60	7970.0	8000.0	0.39	0.48	0.60

REV. X3

SKY-60+

101031

Page 1 of 5



IF/RF MICROWAVE COMPONENTS • ISO 9001 ISO 14001 AS 9100 CERTIFIED • RoHS compliant
P.O. Box 350166, Brooklyn, New York 11235-0006 (718) 934-4500 Fax (718) 332-4661



The Design Engineers Search Engine finds the model you need, instantly • For detailed performance specs & shopping online see



Frequency Mixer

SKY-60+

Typical Performance Data

IF (OUT) (MHz)	LO (MHz)	CONVERSION LOSS VS. IF FREQUENCY @RF(IN)=4250MHz (dB)	IF (OUT) (MHz)	LO (MHz)	CONVERSION LOSS VS. IF FREQUENCY @RF(IN)=2489.89MHz (dB)	IF (OUT) (MHz)	LO (MHz)	CONVERSION LOSS VS. IF FREQUENCY @RF(IN)=6010.1MHz (dB)
		@LO (dBm)			@LO (dBm)			@LO (dBm)
		+7			+7			+7
2650.0	1600.0	10.23	10.1	2500.0	5.29	3050.1	2960.0	10.50
2520.8	1729.2	9.10	90.1	2580.0	5.10	2969.6	3040.5	10.07
2391.5	1858.5	8.30	170.1	2660.0	5.08	2889.0	3121.1	9.67
2262.3	1987.7	7.51	250.1	2740.0	5.29	2808.5	3201.6	9.18
2133.1	2116.9	7.24	330.1	2820.0	5.42	2728.0	3282.1	8.72
2003.8	2246.2	6.80	410.1	2900.0	5.50	2647.5	3362.6	8.32
1874.6	2375.4	6.51	490.1	2980.0	5.61	2566.9	3443.2	8.03
1745.4	2504.6	6.34	570.1	3060.0	5.91	2486.4	3523.7	7.64
1616.2	2633.8	6.45	650.1	3140.0	6.08	2405.9	3604.2	7.42
1486.9	2763.1	6.45	730.1	3220.0	6.09	2325.3	3684.8	7.22
1357.7	2892.3	6.60	810.1	3300.0	6.09	2244.8	3765.3	7.01
1228.5	3021.5	6.69	890.1	3380.0	6.09	2164.3	3845.8	6.98
1080.8	3169.2	6.54	970.1	3460.0	6.17	2083.7	3926.4	7.03
951.5	3298.5	6.20	1050.1	3540.0	6.11	2003.2	4006.9	7.06
803.8	3446.2	6.02	1130.1	3620.0	6.08	1922.7	4087.4	7.11
674.6	3575.4	5.96	1210.1	3700.0	5.92	1842.2	4167.9	6.85
526.9	3723.1	6.06	1290.1	3780.0	5.76	1761.6	4248.5	6.68
397.7	3852.3	6.12	1370.1	3860.0	5.75	1681.1	4329.0	6.70
250.0	4000.0	6.21	1450.1	3940.0	5.74	1600.6	4409.5	6.79
120.8	4129.2	6.14	1530.1	4020.0	5.80	1520.0	4490.1	7.04
31.7	4281.7	6.15	1610.1	4100.0	5.71	1439.5	4570.6	7.37
183.4	4433.4	6.32	1690.1	4180.0	5.55	1359.0	4651.1	7.76
356.9	4606.9	6.78	1770.1	4260.0	5.59	1278.4	4731.7	8.09
508.6	4758.6	6.57	1850.1	4340.0	5.40	1197.9	4812.2	8.08
682.0	4932.0	6.22	1930.1	4420.0	5.29	1117.4	4892.7	7.83
833.8	5083.8	6.34	2010.1	4500.0	5.54	1036.9	4973.2	7.58
1007.2	5257.2	6.77	2090.1	4580.0	5.76	956.3	5053.8	7.34
1159.0	5409.0	6.83	2170.1	4660.0	5.76	875.8	5134.3	7.24
1332.4	5582.4	6.83	2250.1	4740.0	5.83	795.3	5214.8	7.33
1484.1	5734.1	6.74	2330.1	4820.0	5.84	714.7	5295.4	7.44
1657.6	5907.6	6.52	2410.1	4900.0	5.82	634.2	5375.9	7.28
1809.3	6059.3	6.38	2490.1	4980.0	5.96	573.8	5436.3	6.96
1982.7	6232.7	6.25	2570.1	5060.0	6.30	493.3	5516.8	6.57
2134.5	6384.5	6.84	2650.1	5140.0	6.55	432.9	5577.2	6.30
2307.9	6557.9	8.05	2730.1	5220.0	6.79	352.4	5657.7	6.28
2459.7	6709.7	8.72	2810.1	5300.0	7.35	292.0	5718.1	6.28
2633.1	6883.1	9.59	2890.1	5380.0	8.05	211.4	5798.7	6.29
2784.8	7034.8	9.89	2970.1	5460.0	8.68	151.0	5859.1	6.38
2958.3	7208.3	9.22	3050.1	5540.0	9.37	70.5	5939.6	6.36
3110.0	7360.0	10.37	3150.1	5640.0	10.50	10.1	6000.0	6.53

Frequency Mixer

SKY-60+

Typical Performance Data

LO (MHz)	LO-RF ISOLATION (dB)			LO-IF ISOLATION (dB)		
	@LO (dBm)			@LO (dBm)		
	+4	+7	+10	+4	+7	+10
1600.0	31.14	30.53	28.39	11.34	12.71	14.90
1760.5	31.71	31.24	29.01	11.16	13.34	16.13
1921.0	34.86	32.82	30.63	12.24	15.41	18.77
2081.5	35.22	32.96	31.19	13.74	17.31	20.79
2242.0	32.19	29.91	28.82	14.35	17.15	18.79
2402.5	28.32	27.58	27.17	14.97	16.32	16.45
2563.0	26.63	26.11	25.76	13.85	14.31	14.23
2723.5	24.77	24.34	23.98	12.71	12.94	12.62
2884.0	24.35	24.02	24.01	12.34	12.12	11.89
3044.5	23.42	23.47	23.33	11.92	11.74	11.20
3205.0	23.08	23.08	23.06	11.99	11.57	11.03
3365.5	24.34	24.56	24.78	12.09	11.47	11.04
3526.0	26.43	26.90	27.30	11.96	11.30	10.90
3686.5	27.53	28.32	29.33	12.39	11.51	11.15
3847.0	29.30	29.87	30.90	12.85	11.96	11.60
4007.5	33.53	34.31	35.10	13.55	12.60	12.20
4168.0	35.40	34.77	34.43	14.52	13.65	13.05
4328.5	32.82	31.93	31.23	15.54	14.50	14.00
4489.0	32.50	31.31	30.47	16.87	15.88	15.19
4649.5	32.69	31.10	30.00	18.12	16.98	16.41
4810.0	33.34	31.97	30.68	19.38	18.18	17.61
4970.5	31.69	30.54	29.32	20.99	19.61	18.97
5131.0	29.65	28.76	27.69	22.41	20.90	20.05
5291.5	28.04	27.61	26.84	23.86	22.10	21.24
5452.0	28.97	29.14	28.96	25.07	23.10	22.12
5612.5	29.22	29.35	29.05	26.03	24.00	22.78
5773.0	27.41	27.33	27.08	27.13	24.79	23.40
5953.6	25.07	24.75	24.38	27.67	25.11	23.60
6114.1	22.99	22.71	22.07	27.59	25.04	23.44
6294.7	20.63	20.57	20.07	26.99	24.73	23.29
6455.2	18.82	19.15	18.98	26.29	24.10	22.76
6635.7	16.91	17.43	17.61	25.39	23.45	22.30
6796.2	15.28	15.75	15.97	24.43	22.76	21.70
6976.8	14.11	14.72	14.93	24.25	22.74	21.89
7137.3	13.59	14.64	14.90	24.53	23.57	22.34
7317.9	12.87	14.01	14.55	24.87	24.17	23.32
7478.4	12.85	14.07	15.14	25.68	25.13	24.85
7658.9	12.85	14.27	15.54	26.52	26.57	26.75
7819.4	13.32	14.59	15.92	28.14	28.55	29.16
8000.0	13.70	14.83	15.92	26.22	27.49	28.74

RF (IN) (MHz)	LO (MHz)	RF-IF ISOLATION (dB)		
		@LO (dBm)		
		+4	+7	+10
1570.0	1600.0	15.23	14.47	13.83
1730.5	1760.5	16.96	16.81	15.72
1891.0	1921.0	22.10	21.61	19.67
2051.5	2081.5	23.18	22.78	21.24
2212.0	2242.0	18.78	17.91	17.05
2372.5	2402.5	16.17	15.50	14.92
2533.0	2563.0	14.69	14.30	14.00
2693.5	2723.5	13.28	13.08	12.99
2854.0	2884.0	12.39	12.20	12.12
3014.5	3044.5	11.91	11.87	11.85
3175.0	3205.0	11.79	11.78	11.75
3335.5	3365.5	12.40	12.45	12.46
3496.0	3526.0	11.93	12.20	12.40
3656.5	3686.5	12.34	12.56	12.74
3817.0	3847.0	12.72	12.93	13.11
3977.5	4007.5	13.45	13.65	13.76
4138.0	4168.0	14.52	14.58	14.69
4298.5	4328.5	15.15	15.37	15.52
4459.0	4489.0	15.60	15.81	16.03
4619.5	4649.5	16.27	16.44	16.64
4780.0	4810.0	17.00	17.08	17.21
4940.5	4970.5	18.13	18.21	18.27
5101.0	5131.0	19.26	19.33	19.42
5261.5	5291.5	20.32	20.49	20.61
5422.0	5452.0	20.99	21.07	21.10
5582.5	5612.5	22.50	22.42	22.41
5743.0	5773.0	24.53	24.30	24.02
5923.6	5953.6	26.88	26.37	25.97
6084.1	6114.1	28.51	27.55	26.57
6264.7	6294.7	27.78	26.69	25.62
6425.2	6455.2	24.80	24.39	23.64
6605.7	6635.7	21.47	21.54	21.25
6766.2	6796.2	19.20	19.33	19.39
6946.8	6976.8	17.21	17.53	17.55
7107.3	7137.3	16.32	16.72	16.99
7287.9	7317.9	15.02	15.39	15.65
7448.4	7478.4	14.48	14.81	15.08
7628.9	7658.9	14.27	14.59	14.80
7789.4	7819.4	14.49	14.80	15.00
7970.0	8000.0	14.97	15.22	15.43

Frequency Mixer

SKY-60+

Typical Performance Data

RF (IN) (MHz)	LO (MHz)	RF VSWR (:1)			LO (MHz)	LO VSWR (:1)			IF (OUT) (MHz)	IF VSWR @LO=6000MHz (:1)		
		@LO (dBm)				@LO (dBm)				@LO (dBm)		
		+4	+7	+10		+4	+7	+10		+4	+7	+10
1570.0	1600.0	10.31	6.44	4.93	1600.0	23.81	18.11	12.52	10.0	1.21	1.16	1.43
1730.5	1760.5	6.83	4.45	3.74	1760.5	17.93	11.77	9.13	90.5	1.19	1.18	1.45
1891.0	1921.0	3.93	3.10	2.79	1921.0	10.56	7.66	7.50	171.1	1.20	1.18	1.44
2051.5	2081.5	2.95	2.46	2.26	2081.5	7.05	6.09	6.61	251.6	1.21	1.16	1.43
2212.0	2242.0	2.45	2.05	1.82	2242.0	5.46	5.20	5.91	332.1	1.23	1.14	1.40
2372.5	2402.5	2.07	1.81	1.63	2402.5	4.36	4.69	5.59	412.7	1.26	1.10	1.36
2533.0	2563.0	1.91	1.69	1.54	2563.0	3.72	4.21	5.07	493.2	1.32	1.06	1.29
2693.5	2723.5	1.73	1.60	1.52	2723.5	3.12	3.73	4.62	573.8	1.36	1.06	1.26
2854.0	2884.0	1.59	1.48	1.41	2884.0	2.80	3.55	4.51	654.3	1.41	1.08	1.24
3014.5	3044.5	1.56	1.46	1.40	3044.5	2.50	3.30	4.16	734.8	1.47	1.14	1.24
3175.0	3205.0	1.54	1.42	1.35	3205.0	2.40	3.22	4.11	815.4	1.55	1.21	1.23
3335.5	3365.5	1.80	1.59	1.44	3365.5	2.44	3.23	4.08	895.9	1.61	1.27	1.25
3496.0	3526.0	2.12	1.91	1.73	3526.0	2.37	3.11	3.95	976.4	1.68	1.33	1.29
3656.5	3686.5	2.14	1.97	1.83	3686.5	2.44	3.17	3.97	1057.0	1.75	1.40	1.34
3817.0	3847.0	2.17	2.00	1.87	3847.0	2.47	3.20	4.04	1137.5	1.86	1.50	1.40
3977.5	4007.5	2.22	2.06	1.95	4007.5	2.41	3.10	3.90	1218.1	1.99	1.60	1.46
4138.0	4168.0	2.09	1.96	1.88	4168.0	2.64	3.26	4.04	1298.6	2.08	1.66	1.50
4298.5	4328.5	2.19	2.00	1.87	4328.5	2.88	3.48	4.28	1379.1	2.05	1.66	1.48
4459.0	4489.0	2.56	2.28	2.09	4489.0	3.20	3.73	4.47	1459.7	1.96	1.60	1.44
4619.5	4649.5	2.77	2.47	2.26	4649.5	3.53	4.05	4.80	1540.2	1.86	1.52	1.40
4780.0	4810.0	2.83	2.53	2.30	4810.0	3.82	4.31	5.07	1620.7	1.79	1.48	1.38
4940.5	4970.5	2.56	2.25	2.08	4970.5	4.29	4.55	5.23	1701.3	1.72	1.43	1.34
5101.0	5131.0	2.38	2.02	1.81	5131.0	5.02	5.10	5.68	1781.8	1.62	1.35	1.27
5261.5	5291.5	2.46	2.08	1.86	5291.5	5.72	5.51	5.99	1862.3	1.51	1.26	1.22
5422.0	5452.0	3.38	2.97	2.67	5452.0	6.19	5.61	5.95	1942.9	1.40	1.20	1.20
5582.5	5612.5	3.47	3.06	2.73	5612.5	6.73	5.79	5.95	2023.4	1.29	1.14	1.20
5743.0	5773.0	3.28	2.89	2.59	5773.0	7.73	6.01	5.91	2104.0	1.21	1.12	1.22
5923.6	5953.6	3.00	2.59	2.32	5953.6	8.01	5.93	5.66	2164.4	1.18	1.10	1.22
6084.1	6114.1	2.63	2.23	1.99	6114.1	7.97	5.68	5.33	2244.9	1.08	1.13	1.27
6264.7	6294.7	2.30	1.92	1.72	6294.7	7.70	5.39	4.95	2305.3	1.02	1.22	1.39
6425.2	6455.2	1.97	1.61	1.45	6455.2	7.25	4.93	4.43	2385.8	1.08	1.29	1.48
6605.7	6635.7	1.93	1.62	1.45	6635.7	6.19	4.21	3.73	2446.2	1.15	1.38	1.57
6766.2	6796.2	1.98	1.79	1.65	6796.2	5.09	3.58	3.20	2526.8	1.36	1.61	1.84
6946.8	6976.8	1.92	1.83	1.77	6976.8	4.39	2.99	2.59	2587.2	1.52	1.80	2.07
7107.3	7137.3	2.00	1.87	1.77	7137.3	3.90	2.57	2.15	2667.7	1.73	2.04	2.32
7287.9	7317.9	2.36	2.29	2.22	7317.9	3.08	2.05	1.72	2728.1	1.95	2.29	2.61
7448.4	7478.4	2.45	2.36	2.30	7478.4	2.43	1.66	1.43	2808.7	2.29	2.69	3.03
7628.9	7658.9	2.78	2.65	2.56	7658.9	1.81	1.31	1.35	2869.1	2.53	2.92	3.25
7789.4	7819.4	2.81	2.65	2.55	7819.4	1.43	1.22	1.49	2949.6	2.92	3.30	3.61
7970.0	8000.0	2.85	2.67	2.55	8000.0	1.32	1.39	1.70	3010.0	3.42	3.82	4.13

Harmonics Tables

RF HARMONICS ORDER

	(-dBm)	(-dBc)										
0	-	-	+13	20	18	35	23	---	---	---	---	---
1	-	9	+0	36	29	31	38	54	---	---	---	---
2	>90	53	58	50	62	58	62	47	58	---	---	---
3	>90	>70	>70	>70	>70	>70	>70	>70	67	>70	---	---
4	>90	>70	>70	>70	>70	>70	>70	>70	>70	>70	>70	---
5	>90	>70	>70	>70	>70	>70	>70	>70	>70	>70	>70	>70
6	---	---	>70	>70	>70	>70	>70	>70	>70	>70	>70	>70
7	---	---	---	>70	>70	>70	>70	>70	>70	>70	>70	>70
8	---	---	---	---	>70	>70	>70	>70	>70	>70	>70	>70
9	---	---	---	---	---	>70	>70	>70	>70	>70	>70	>70
10	---	---	---	---	---	---	>70	>70	>70	>70	>70	>70
	RF CAL	0	1	2	3	4	5	6	7	8	9	10

Test conditions: RF IN: 4250 MHz; -14.00 dBm.
 LO IN: 4280 MHz; +7.00 dBm
 IF OUT: 30 MHz; -20.38 dBm

RF HARMONICS ORDER

	(-dBm)	(-dBc)										
0	-	-	+3	29	30	59	39	---	---	---	---	---
1	-	9	+0	37	30	34	40	54	---	---	---	---
2	75	43	48	40	55	51	58	43	52	---	---	---
3	>90	57	58	57	52	56	58	53	53	>80	---	---
4	>90	57	71	70	75	>80	66	69	75	56	>80	---
5	>90	>80	74	77	>80	75	62	76	72	78	69	77
6	---	---	>80	77	>80	>80	>80	79	78	>80	>80	76
7	---	---	---	>80	>80	>80	>80	>80	79	>80	>80	>80
8	---	---	---	---	>80	>80	>80	>80	>80	>80	>80	>80
9	---	---	---	---	---	>80	>80	>80	>80	>80	>80	>80
10	---	---	---	---	---	---	>80	>80	>80	>80	>80	>80
	RF CAL	0	1	2	3	4	5	6	7	8	9	10

LO HARMONICS ORDER

Test conditions: RF IN: 4250 MHz; -4.00 dBm.
 LO IN: 4280 MHz; +7.00 dBm
 IF OUT: 30 MHz; -10.48 dBm

- Notes: 1. All Harmonics are in (dBc) relative to IF OUTPUT.
 2. + entry denotes harmonics are in (dBc) above IF OUTPUT.
 3. RF Cal represent the Harmonics level of the RF input signal to the mixer.

Typical Performance Curves

Conversion Loss @ IF=30MHz

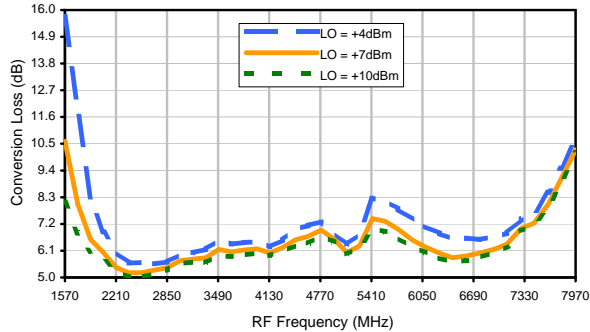

Conversion Loss vs. LO @ RF=4250MHz

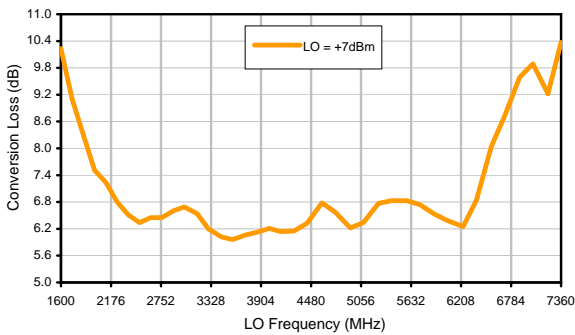

Conversion Loss vs. IF @ RF=4250MHz

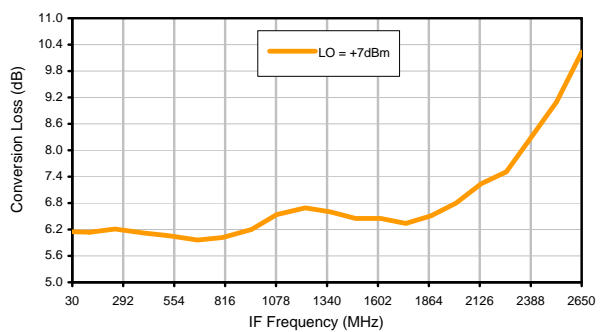

Conversion Loss vs. IF @ RF=2489.89MHz

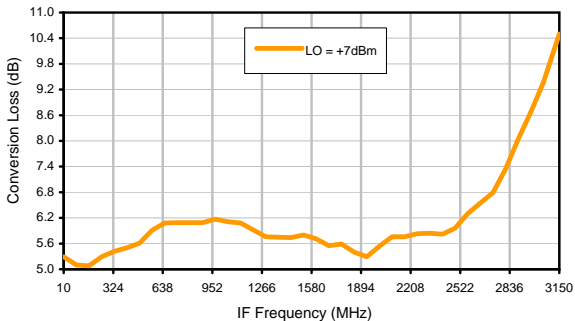

Conversion Loss vs. IF @ RF=6010.1MHz

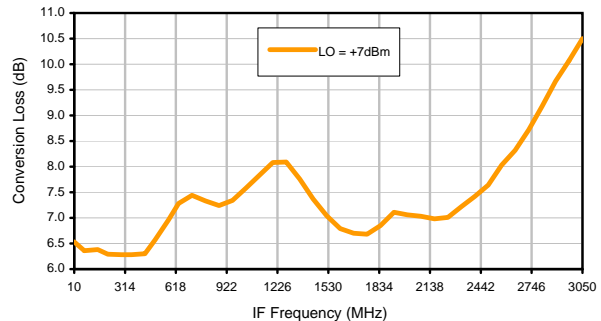

IP3 Input

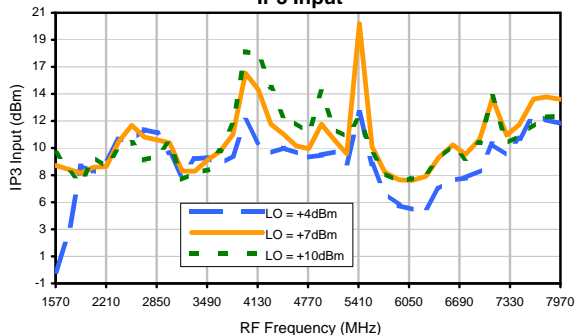

Compression @ RF IN=+1dBm

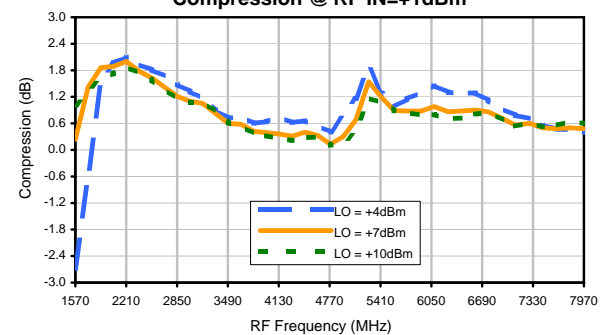

Frequency Mixer

Typical Performance Curves

SKY-60+

LO-RF Isolation

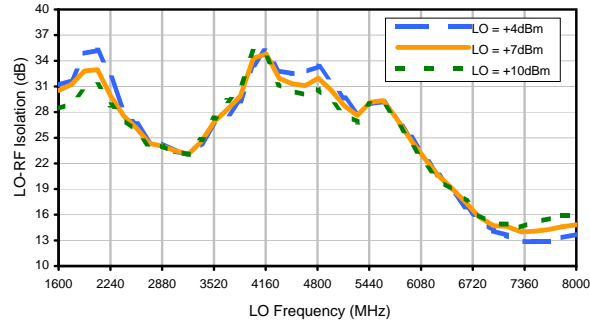

LO-IF Isolation

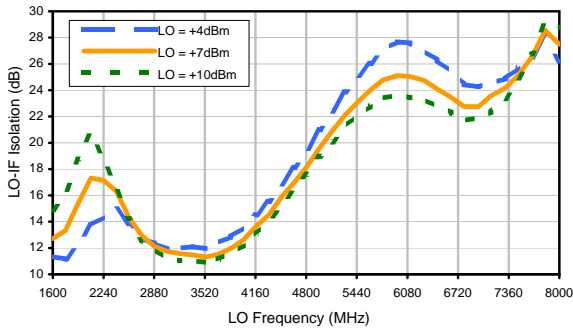

RF-IF Isolation

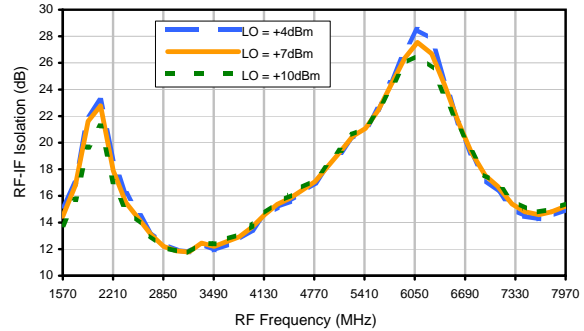

RF VSWR

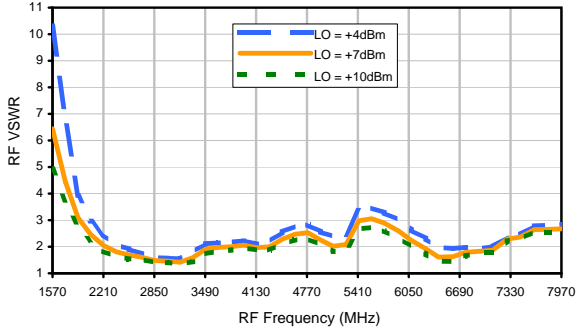

LO VSWR

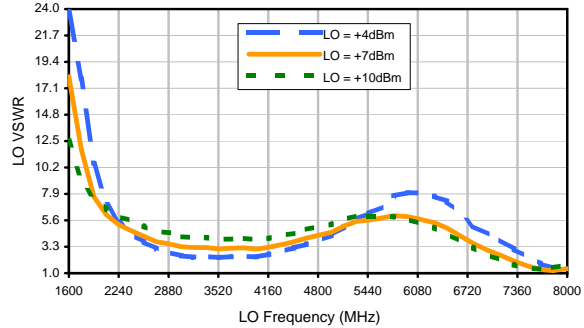

IF VSWR

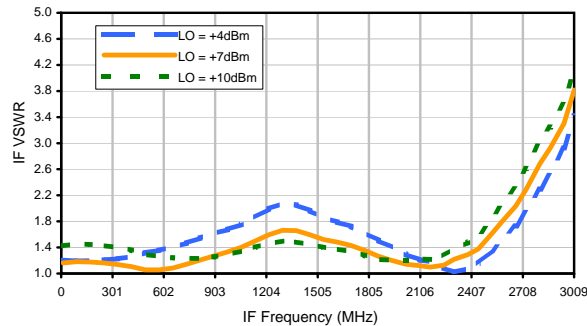

Harmonics Tables

RF HARMONICS ORDER

	(-dBm)	(-dBc)										
0	-	-	+13	20	18	35	23	---	---	---	---	---
1	-	9	+0	36	29	31	38	54	---	---	---	---
2	>90	53	58	50	62	58	62	47	58	---	---	---
3	>90	>70	>70	>70	>70	>70	>70	>70	67	>70	---	---
4	>90	>70	>70	>70	>70	>70	>70	>70	>70	>70	>70	---
5	>90	>70	>70	>70	>70	>70	>70	>70	>70	>70	>70	>70
6	---	---	>70	>70	>70	>70	>70	>70	>70	>70	>70	>70
7	---	---	---	>70	>70	>70	>70	>70	>70	>70	>70	>70
8	---	---	---	---	>70	>70	>70	>70	>70	>70	>70	>70
9	---	---	---	---	---	>70	>70	>70	>70	>70	>70	>70
10	---	---	---	---	---	---	>70	>70	>70	>70	>70	>70
	RF CAL	0	1	2	3	4	5	6	7	8	9	10

Test conditions: RF IN: 4250 MHz; -14.00 dBm.
 LO IN: 4280 MHz; +7.00 dBm
 IF OUT: 30 MHz; -20.38 dBm

RF HARMONICS ORDER

	(-dBm)	(-dBc)										
0	-	-	+3	29	30	59	39	---	---	---	---	---
1	-	9	+0	37	30	34	40	54	---	---	---	---
2	75	43	48	40	55	51	58	43	52	---	---	---
3	>90	57	58	57	52	56	58	53	53	>80	---	---
4	>90	57	71	70	75	>80	66	69	75	56	>80	---
5	>90	>80	74	77	>80	75	62	76	72	78	69	77
6	---	---	>80	77	>80	>80	>80	79	78	>80	>80	76
7	---	---	---	>80	>80	>80	>80	>80	79	>80	>80	>80
8	---	---	---	---	>80	>80	>80	>80	>80	>80	>80	>80
9	---	---	---	---	---	>80	>80	>80	>80	>80	>80	>80
10	---	---	---	---	---	---	>80	>80	>80	>80	>80	>80
	RF CAL	0	1	2	3	4	5	6	7	8	9	10

LO HARMONICS ORDER

Test conditions: RF IN: 4250 MHz; -4.00 dBm.
 LO IN: 4280 MHz; +7.00 dBm
 IF OUT: 30 MHz; -10.48 dBm

- Notes: 1. All Harmonics are in (dBc) relative to IF OUTPUT.
 2. + entry denotes harmonics are in (dBc) above IF OUTPUT.
 3. RF Cal represent the Harmonics level of the RF input signal to the mixer.

Outline Dimensions

BJ293
BJ398

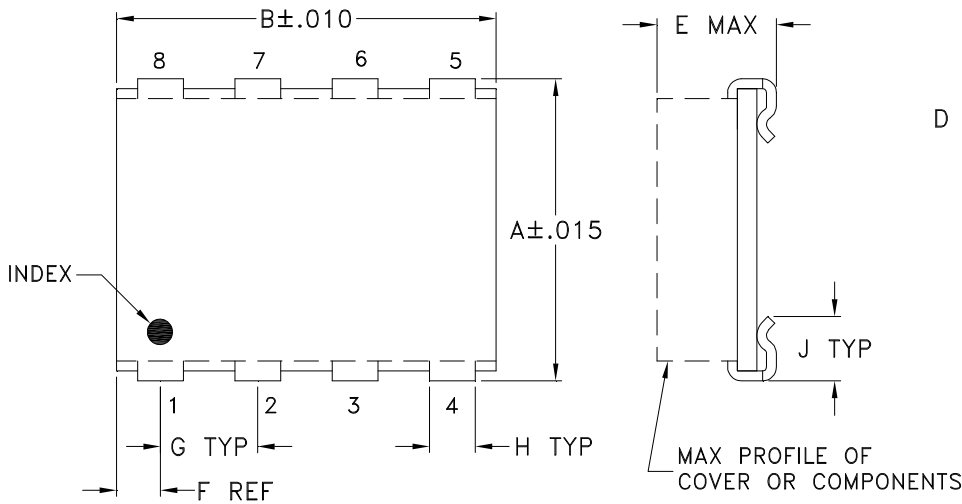

PCB Land Pattern

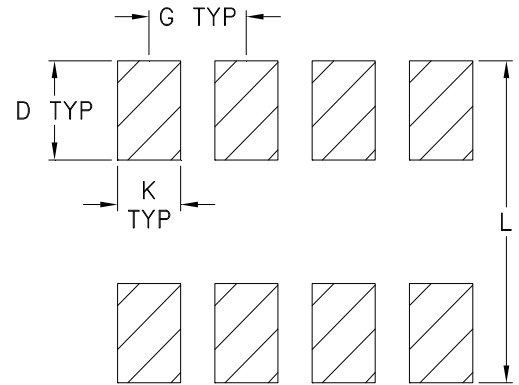

Suggested Layout,
Tolerance to be within $\pm .002$

CASE#	A	B	C	D	E	F	G	H	J	K	L	WT. GRAMS
BJ293	.395 (10.03)	.500 (12.70)	-- --	.100 (2.54)	.230 (5.84)	.100 (2.54)	.100 (2.54)	.047 (1.19)	.065 (1.65)	.065 (1.65)	.425 (10.80)	.80
BJ398	.305 (7.75)	.390 (9.91)	-- --	.100 (2.54)	.105 (2.67)	.045 (1.14)	.100 (2.54)	.047 (1.19)	.065 (1.65)	.065 (1.65)	.325 (8.26)	.20

Dimensions are in inches (mm). Tolerances: 2Pl. $\pm .01$; 3Pl. $\pm .005$

Notes:

- Case material: Plastic.
- Base material: Printed wiring laminate.
- Termination finish:
 - For RoHS Case Styles: Tin plate over Nickel plate. All models, (+) suffix.
 - For RoHS-5 Case Styles: Tin-Lead plate. All models, no (+) suffix.



INTERNET <http://www.minicircuits.com>

P.O. Box 350166, Brooklyn, New York 11235-0003 (718) 934-4500 Fax (718) 332-4661

Distribution Centers NORTH AMERICA 800-654-7949 • 417-335-5935 • Fax 417-335-5945 • EUROPE 44-1252-832600 • Fax 44-1252-837010

Mini-Circuits ISO 9001 & ISO 14001 Certified

Tape & Reel Packaging TR-F29

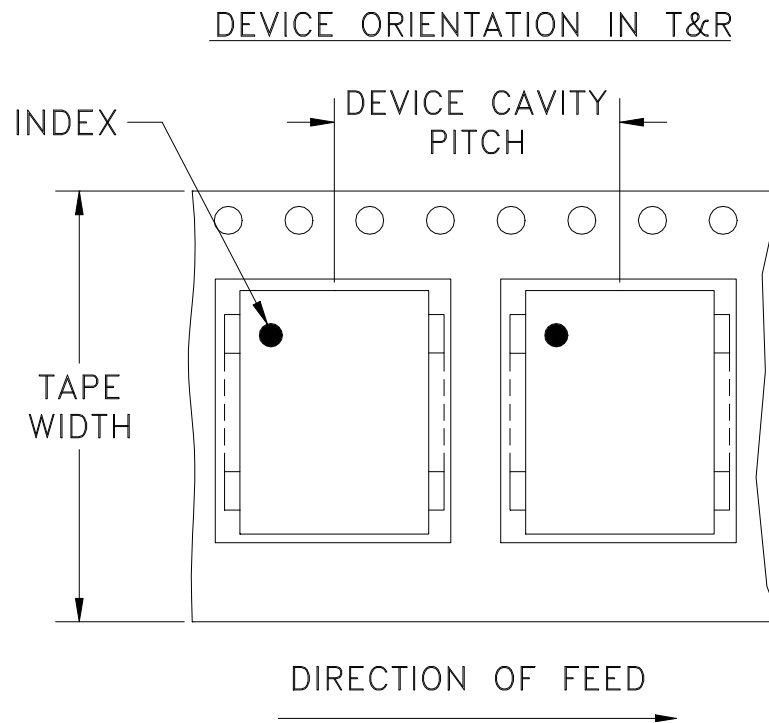

Tape Width, mm	Device Cavity Pitch, mm	Reel Size, inches	Devices per Reel
24	12	13	500

Mini-Circuits carrier tape materials provide protection from ESD (Electro-Static Discharge) during handling and transportation. Tapes are static dissipative and comply with industry standards EIA-481/EIA-541.

Go to: www.minicircuits.com/pages/pdfs/tape.pdf

 **Mini-Circuits**[®]

INTERNET <http://www.minicircuits.com>

P.O. Box 350166, Brooklyn, New York 11235-0003 (718) 934-4500 Fax (718) 332-4661

Distribution Centers NORTH AMERICA 800-654-7949 • 417-335-5935 • Fax 417-335-5945 • EUROPE 44-1252-832600 • Fax 44-1252-837010

Mini-Circuits ISO 9001 & ISO 14001 Certified

THIRD ANGLE PROJECTION

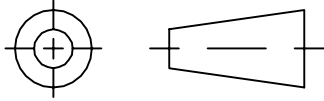

REVISIONS

REV	ECN No.	DESCRIPTION	DATE	DR	AUTH
OR	M88233	NEW RELEASE	08/06/03	AV	WL
A	M102713	UPDATED NOTES, ADDED "...WITH SMOBC"	01/16/06	GT	IL

SUGGESTED MOUNTING CONFIGURATION
FOR BJ398 CASE STYLE, "je/hp" PIN CONNECTIONS

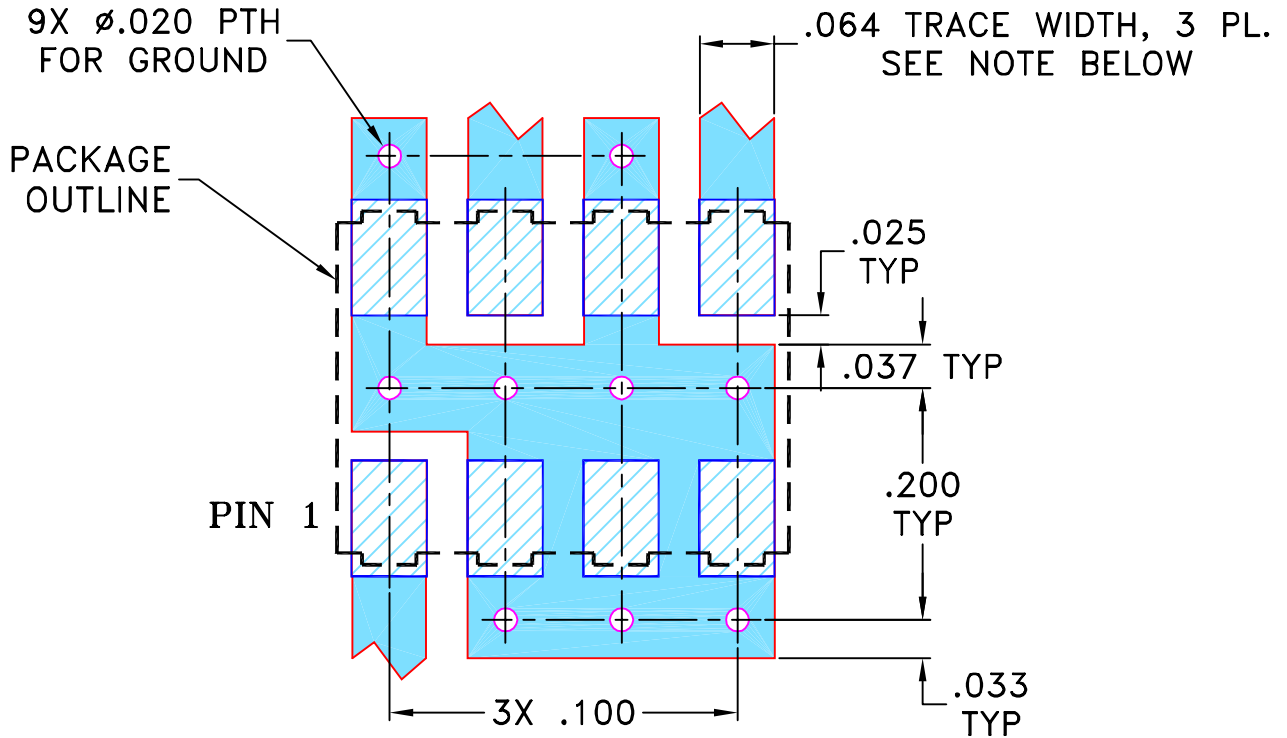

NOTES:

- TRACE WIDTH IS SHOWN FOR ROGERS R04350B WITH DIELECTRIC THICKNESS .030" ± .002".
COPPER: 1/2 OZ. EACH SIDE.
FOR OTHER MATERIALS TRACE WIDTH MAY NEED TO BE MODIFIED.

- BOTTOM SIDE OF THE PCB IS CONTINUOUS GROUND PLANE.

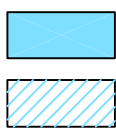

DENOTES PCB COPPER LAYOUT WITH SMOBC (SOLDER MASK OVER BARE COPPER)
DENOTES COPPER LAND PATTERN FREE OF SOLDER MASK

UNLESS OTHERWISE SPECIFIED

DIMENSIONS ARE IN INCHES
TOLERANCES ON:
2 PL DECIMALS ±
3 PL DECIMALS ± .005
ANGLES ±
FRACTIONS ±

	INITIALS	DATE
DRAWN	AV	07/28/03
CHECKED	IL	08/06/03
APPROVED	WL	08/06/03



Mini-Circuits®

13 Neptune Avenue
Brooklyn NY 11235

PL, je/hp, BJ398, SKY, TB-11

Mini-Circuits®
THIS DOCUMENT AND ITS CONTENTS ARE THE PROPERTY OF MINI-CIRCUITS. EXCEPT FOR USE EXPRESSLY GRANTED, IN WRITING, TO ITS VENDORS, VENDEE AND THE UNITED STATES GOVERNMENT, MINI-CIRCUITS RESERVES ALL PROPRIETARY DESIGN, USE, MANUFACTURING AND REPRODUCTION RIGHTS THERETO. THESE CONTENTS SHALL NOT BE USED, DUPLICATED OR DISCLOSED TO ANY OUTSIDE PARTY, IN WHOLE OR IN PART, WITHOUT WRITTEN PERMISSION OF MINI-CIRCUITS.

SIZE A	CODE IDENT 15542	DRAWING NO: 98-PL-056	REV: A
FILE: 98PL056	SCALE: 6:1	SHEET: 1 OF 1	

Evaluation Board and Circuit

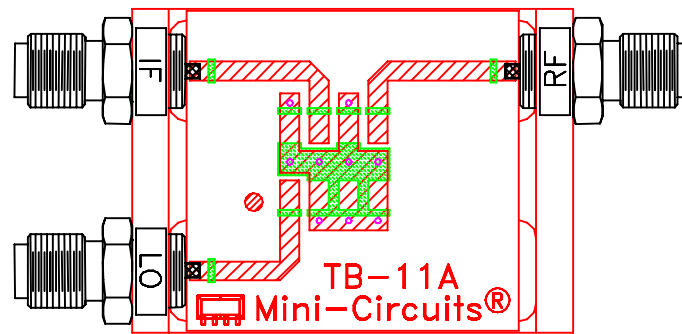

TB-11

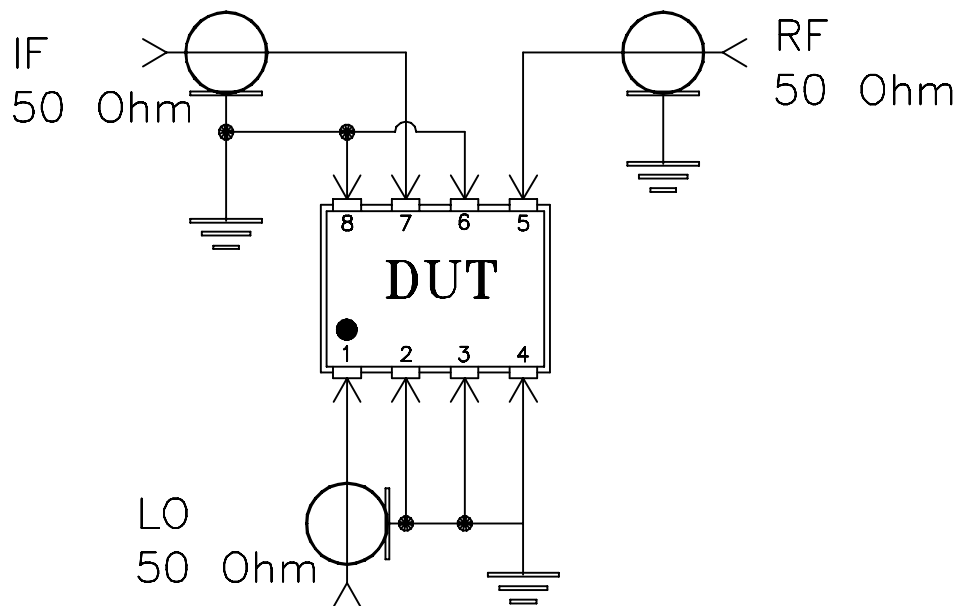

Schematic Diagram

Notes:

1. SMA Female connectors.
2. PCB Material: Rogers R04350 or equivalent,
Dielectric Constant=3.5, Thickness=.030 inch.

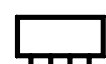
 Mini-Circuits®



All Mini-Circuits products are manufactured under exacting quality assurance and control standards, and are capable of meeting published specifications after being subjected to any or all of the following physical and environmental test.

Specification	Test/Inspection Condition	Reference/Spec
Operating Temperature	-40° to 85°C Ambient Environment	Individual Model Data Sheet
Storage Temperature	-55° to 100° C Ambient Environment	Individual Model Data Sheet
Humidity	90 to 95% RH, 240 hours, 50°C	MIL-STD-202, Method 103, Condition A, Except 50°C and end-point electrical test done within 12 hours
Thermal Shock	-55° to 100°C, 100 cycles	MIL-STD-202, Method 107, Condition A-3, except +100°C
Solder Reflow Heat	Sn-Pb Eutetic Process: 225°C peak Pb-Free Process 245° - 250°C peak	J-STD-020, Table 4-1, 4-2 and 5-2, Figure 5-1
Solderability	10X Magnification	J-STD-002, 95% Coverage
Vibration (High Frequency)	20g peak, 10-2000 Hz, 12 times in each of three perpendicular directions (total 36)	MIL-STD-202, Method 204, Condition D
Mechanical Shock	50g, 11 ms, 1/2-sine, 18 shocks: 3 each direction, each of 3 axes	MIL-STD-202, Method 213, Condition A
Marking Resistance to Solvents	Isopropyl alcohol + mineral spirits at 25°C; terpene defluxer at 25°C; distilled water + proylene glycol monomethyl ether + monoethanolamine at 63°C to 70°C	MIL-STD-202, Method 215