

Product Features

- DC-3 GHz
- Single Voltage Supply
- Internally Matched to 50 Ohms
- Unconditionally Stable
- Low Performance Variation Over Temperature
- Transient Protected
- Aqueous washable
- Protected By US Patent 6,943,629



Generic photo used for illustration purposes only

ERA-33SM+

CASE STYLE: WW107

+RoHS Compliant

The +Suffix identifies RoHS Compliance. See our web site for RoHS Compliance methodologies and qualifications

Typical Applications

- Cellular/ PCS/ 3G Base Station
- CATV, Cable Modem & DBS
- Fixed Wireless & WLAN
- Microwave Radio & Test Equipment

General Description

ERA-33SM+ (RoHS compliant) is a wideband amplifier offering high dynamic range. It has repeatable performance from lot to lot. It is enclosed in an Micro-X package. ERA-33SM+ uses Darlington configuration and is fabricated using InGaP HBT technology. Expected MTTF is 5,250 years at 85°C case temperature.

simplified schematic and pin description

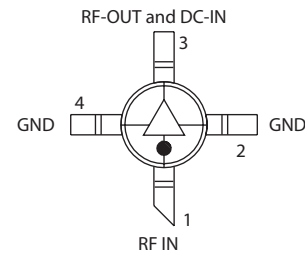
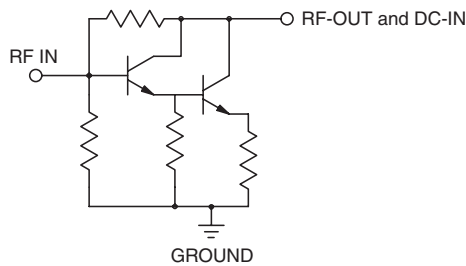

Function	Pin Number	Description
RF IN	1	RF input pin. This pin requires the use of an external DC blocking capacitor chosen for the frequency of operation.
RF-OUT and DC-IN	3	RF output and bias pin. DC voltage is present on this pin; therefore a DC blocking capacitor is necessary for proper operation. An RF choke is needed to feed DC bias without loss of RF signal due to the bias connection, as shown in "Recommended Application Circuit".
GND	2,4	Connections to ground. Use via holes as shown in "Suggested Layout for PCB Design" to reduce ground path inductance for best performance.

Notes

- A. Performance and quality attributes and conditions not expressly stated in this specification document are intended to be excluded and do not form a part of this specification document.
 B. Electrical specifications and performance data contained in this specification document are based on Mini-Circuit's applicable established test performance criteria and measurement instructions.
 C. The parts covered by this specification document are subject to Mini-Circuits standard limited warranty and terms and conditions (collectively, "Standard Terms"); Purchasers of this part are entitled to the rights and benefits contained therein. For a full statement of the Standard Terms and the exclusive rights and remedies thereunder, please visit Mini-Circuits' website at www.minicircuits.com/MCLStore/terms.jsp



Electrical Specifications at 25°C and 40mA, unless noted

Parameter		Min.	Typ.	Max.	Units	Cpk
Frequency Range*		DC		3	GHz	
Gain	f=0.1 GHz	18.7	19.3	20.6	dB	≥ 1.5
	f=1 GHz	—	18.7	—		
	f=2 GHz	15	17.4	18.5		
	f=3 GHz	14.2	15.9	17.3		
Magnitude of Gain Variation versus Temperature (values are negative)	f=0.1 GHz	—	0.0021	.004	dB/°C	
	f=1 GHz	—	0.0029	.005		
	f=2 GHz	—	0.0035	.007		
	f=3 GHz	—	0.004	.008		
Input Return Loss	f=0.1 GHz		35		dB	
	f=1 GHz		25			
	f=2 GHz		26			
	f=3 GHz		28			
Output Return Loss	f=0.1 GHz		35		dB	
	f=1 GHz		22			
	f=2 GHz		20			
	f=3 GHz		20			
Reverse Isolation	f=1.0 GHz	19	22.5	—	dB	
Output Power @ 1 dB compression	f=0.1 GHz	—	14.3	—	dBm	≥ 1.33
	f=1 GHz	—	16.6	—		
	f=2 GHz	11.5	13.5	—		
	f=3 GHz	—	13.9	—		
Saturated Output Power (at 3dB compression)	f=0.1 GHz		15.5		dBm	
	f=1 GHz		15.5			
	f=2 GHz		15			
	f=3 GHz		15			
Output IP3	f=0.1 GHz	27	29.5	—	dBm	≥ 1.33
	f=1 GHz	—	30	—		
	f=2 GHz	27.5	30.3	—		
	f=3 GHz	27	30	—		
Noise Figure	f=0.1 GHz	—	3.2	4.0	dB	≥ 1.33
	f=1GHz	—	3.3	4.0		
	f=2 GHz	—	3.3	4.1		
	f=3 GHz	—	3.4	4.2		
Group Delay	f=2 GHz		82		psec	
Recommended Device Operating Current			40		mA	
Device Operating Voltage		3.9	4.3	4.6	V	≥ 1.5
Device Voltage Variation vs. Temperature at 40mA			-2.9		mV/°C	
Device Voltage Variation vs. Current at 25°C			3.8		mV/mA	
Thermal Resistance, junction-to-case ¹			140		°C/W	

*Guaranteed specification DC-3 GHz. Low frequency cut off determined by external coupling capacitors.

Absolute Maximum Ratings

Parameter	Ratings
Operating Temperature*	-45°C to 85°C
Storage Temperature	-65°C to 150°C
Operating Current	75 mA
Power Dissipation	330 mW
Input Power	13 dBm

Note: Permanent damage may occur if any of these limits are exceeded. These ratings are not intended for continuous normal operation.
¹Case is defined as ground leads.
 *Based on typical case temperature rise 5°C above ambient.

Notes

- A. Performance and quality attributes and conditions not expressly stated in this specification document are intended to be excluded and do not form a part of this specification document.
- B. Electrical specifications and performance data contained in this specification document are based on Mini-Circuit's applicable established test performance criteria and measurement instructions.
- C. The parts covered by this specification document are subject to Mini-Circuits standard limited warranty and terms and conditions (collectively, "Standard Terms"); Purchasers of this part are entitled to the rights and benefits contained therein. For a full statement of the Standard Terms and the exclusive rights and remedies thereunder, please visit Mini-Circuits' website at www.minicircuits.com/MCLStore/terms.jsp



Product Marking

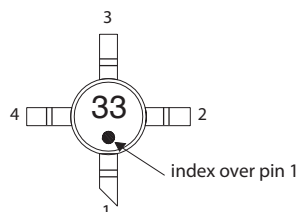

Markings in addition to model number designation may appear for internal quality control purposes.

Additional Detailed Technical Information

Additional information is available on our web site. To access this information enter the model number on our web site home page.

Performance data, graphs, s-parameter data set (.zip file)

Case Style: WW107

Plastic micro-x, .085 body diameter, lead finish: Matte-Tin

Tape & Reel: F4

7" Reels with 20, 50, 100, 200, 500, 1K devices

Suggested Layout for PCB Design: PL-075

Evaluation Board: TB-408-33+

Environmental Ratings: ENV08T2

Recommended Application Circuit

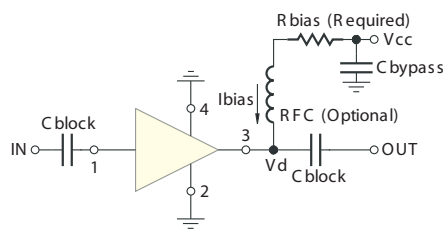

Test Board includes case, connectors, and components (in bold) soldered to PCB

R BIAS	
Vcc	"1%" Res. Values (ohms) for Optimum Biasing
7	69.8
8	93.1
9	115
10	140
11	165
12	191
13	215
14	243
15	267
16	287
17	316
18	340
19	365
20	392

Notes

- A. Performance and quality attributes and conditions not expressly stated in this specification document are intended to be excluded and do not form a part of this specification document.
- B. Electrical specifications and performance data contained in this specification document are based on Mini-Circuit's applicable established test performance criteria and measurement instructions.
- C. The parts covered by this specification document are subject to Mini-Circuits standard limited warranty and terms and conditions (collectively, "Standard Terms"); Purchasers of this part are entitled to the rights and benefits contained therein. For a full statement of the Standard Terms and the exclusive rights and remedies thereunder, please visit Mini-Circuits' website at www.minicircuits.com/MCLStore/terms.jsp



ESD Rating

Human Body Model (HBM): Class 1B (500 v to < 1000 v) in accordance with ANSI/ESD STM 5.1 - 2001

Machine Model (MM): Class M1 (< 100 v) in accordance with ANSI/ESD STM 5.2 - 1999

MSL Rating

Moisture Sensitivity: MSL1 in accordance with IPC/JEDECJ-STD-020C

No.	Test Required	Condition	Standard	Quantity
1	Visual Inspection	Low Power Microscope Magnification 40x	MIP-IN-0003 (MCT spec)	45 units
2	Electrical Test	Room Temperature	SCD (MCL spec)	45 units
3	SAM Analysis	Less than 10% growth in term of delamination	J-Std-020C (Jedec Standard)	45 units
4	Moisture Sensitivity Level 1	Bake at 125°C for 24 hours Soak at 85°C/85%RH for 168 hours Reflow 3 cycles at 260°C peak	J-Std-020C (Jedec Standard)	45 units

MSL Test Flow Chart

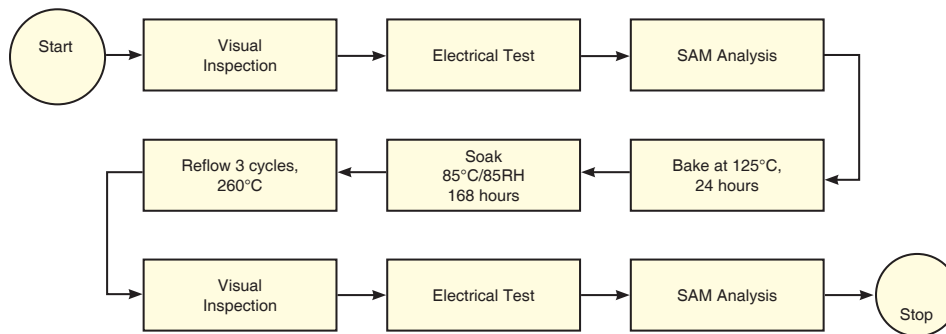

Notes

- A. Performance and quality attributes and conditions not expressly stated in this specification document are intended to be excluded and do not form a part of this specification document.
- B. Electrical specifications and performance data contained in this specification document are based on Mini-Circuit's applicable established test performance criteria and measurement instructions.
- C. The parts covered by this specification document are subject to Mini-Circuits standard limited warranty and terms and conditions (collectively, "Standard Terms"); Purchasers of this part are entitled to the rights and benefits contained therein. For a full statement of the Standard Terms and the exclusive rights and remedies thereunder, please visit Mini-Circuits' website at www.minicircuits.com/MCLStore/terms.jsp



Typical Performance Data

NOTE: Use PDF Bookmarks to view DATA at required conditions

Definitions:

Input Return Loss = -S11 (dB)

Gain(Power Gain) = S21 (dB)

Reverse Isolation = -S12 (dB)

Output Return Loss = -S22 (dB)

TEST CONDITIONS: I_{cc} = 40mA, V_d = 4.23V @Temperature = +25degC

FREQ	Gain	Isolation	Input Return Loss	Output Return Loss	Stability		FREQ	IP3 Output	1dB Comp. Output	Noise Figure
(MHz)	(dB)	(dB)	(dB)	(dB)	K	Delta	(MHz)	(dBm)	(dBm)	(dB)
50	20.21	23.30	39.24	32.51	1.06	0.70	50	28.76	15.39	3.14
100	20.20	23.28	39.64	31.50	1.06	0.70	100	28.42	15.39	3.06
200	20.13	23.26	39.01	30.86	1.06	0.70	200	28.92	15.42	3.09
300	20.07	23.26	36.15	29.48	1.07	0.69	300	29.23	15.36	3.19
400	20.01	23.17	35.87	28.21	1.07	0.69	400	28.88	15.23	3.25
500	19.90	23.18	33.97	27.47	1.07	0.69	500	28.53	15.30	3.11
600	19.81	23.15	33.16	26.33	1.07	0.68	600	28.88	15.40	3.21
700	19.71	23.11	32.21	25.79	1.07	0.67	700	29.55	15.43	3.12
800	19.59	23.10	31.50	24.95	1.08	0.67	800	29.49	15.41	3.16
900	19.44	23.09	30.96	24.47	1.08	0.66	900	29.48	15.45	3.14
1000	19.29	23.06	30.52	23.84	1.09	0.65	1000	29.30	15.40	3.07
1100	19.14	23.03	30.32	23.46	1.10	0.64	1100	29.52	14.99	3.00
1200	18.99	22.97	29.74	23.22	1.10	0.63	1200	29.39	15.21	3.05
1300	18.81	22.95	29.78	22.80	1.11	0.62	1300	29.73	15.25	3.16
1400	18.66	22.89	29.88	22.62	1.11	0.61	1400	29.63	15.38	3.11
1500	18.49	22.85	30.20	22.47	1.12	0.60	1500	29.26	15.08	3.00
1600	18.30	22.80	30.08	22.39	1.13	0.59	1600	30.19	14.97	3.09
1800	17.94	22.74	30.30	22.15	1.15	0.57	1700	30.74	15.44	3.26
2000	17.59	22.61	31.58	22.36	1.16	0.56	1800	31.06	15.03	3.09
2200	17.21	22.51	31.30	22.32	1.18	0.54	1900	30.68	15.39	3.08
2400	16.85	22.38	33.22	22.51	1.20	0.53	2000	30.91	15.42	3.13
2600	16.48	22.29	33.81	22.82	1.23	0.51	2100	30.82	15.45	3.18
2800	16.13	22.21	35.56	22.94	1.25	0.50	2200	30.75	15.27	3.19
3000	15.79	22.06	38.57	23.22	1.27	0.49	2300	31.15	15.14	3.03
3200	15.44	21.96	37.87	23.41	1.29	0.47	2400	31.41	15.14	2.95
3400	15.12	21.83	38.55	23.25	1.31	0.46	2500	30.85	15.05	3.00
3600	14.79	21.72	34.83	23.39	1.33	0.45	2600	31.12	15.02	3.07
3800	14.45	21.61	32.67	22.69	1.35	0.44	2700	30.18	14.90	3.07
4000	14.14	21.55	30.49	22.19	1.38	0.43	2800	30.11	14.65	3.10
4500	13.30	21.50	27.02	20.18	1.47	0.39	2900	30.03	14.36	3.18
5000	12.64	21.45	23.25	18.76	1.54	0.37	3000	30.13	14.39	3.17
5500	12.14	21.47	20.06	17.51	1.61	0.35	3100	29.98	14.11	3.16
6000	11.77	21.35	17.12	17.48	1.64	0.35	3200	29.88	13.95	3.12
6500	11.52	21.24	14.93	18.21	1.64	0.35	3300	29.24	13.95	3.15
7000	11.31	21.24	13.42	18.72	1.66	0.34	3400	29.21	13.85	3.20
8000	10.83	20.79	10.38	21.24	1.59	0.33	3500	28.60	13.53	3.16
9000	9.87	20.13	8.00	18.35	1.50	0.31	3600	28.98	13.31	3.19
10000	8.22	19.42	6.04	14.71	1.44	0.27	3700	28.14	13.43	3.18
11000	6.30	18.70	4.85	11.23	1.37	0.24	3800	27.48	13.21	3.20
12000	4.26	18.01	4.04	8.29	1.25	0.24	3900	27.32	12.72	3.22
13000	2.03	17.91	3.47	6.18	1.16	0.25	4000	27.77	12.88	3.29

REV. X1

ERA-33SM+

120119

Page 1 of 11



IF/RF MICROWAVE COMPONENTS • ISO 9001 ISO 14001 AS 9100 CERTIFIED RoHS compliant

P.O. Box 350166, Brooklyn, New York 11235-0003 (718) 934-4500 Fax (718) 332-4661



The Design Engineers Search Engine finds the model you need, Instantly • For detailed performance specs & shopping online see



Typical Performance Data

Definitions:

Input Return Loss = -S11 (dB)

Gain(Power Gain) = S21 (dB)

Reverse Isolation = -S12 (dB)

Output Return Loss = -S22 (dB)

TEST CONDITIONS: Icc = 32mA, Vd = 4.19V @ Temperature = +25degC

FREQ	Gain	Isolation	Input Return Loss	Output Return Loss	Stability		FREQ	IP3 Output	1dB Comp. Output	Noise Figure
(MHz)	(dB)	(dB)	(dB)	(dB)	K	Delta	(MHz)	(dBm)	(dBm)	(dB)
50	19.86	22.75	29.02	41.16	1.05	0.72	50	25.42	12.86	3.07
100	19.84	22.97	28.35	40.09	1.06	0.70	100	25.14	12.98	3.05
200	19.82	22.97	28.74	37.33	1.07	0.70	200	25.57	12.97	3.08
300	19.74	22.97	28.77	33.74	1.07	0.69	300	25.80	12.89	3.19
400	19.67	22.89	28.96	32.10	1.07	0.69	400	25.60	12.77	3.19
500	19.61	22.94	28.55	30.40	1.07	0.68	500	25.30	12.91	3.06
600	19.49	22.89	29.24	28.95	1.08	0.68	600	25.56	13.07	3.12
700	19.39	22.89	28.66	28.09	1.08	0.67	700	26.19	13.08	3.07
800	19.28	22.84	28.46	27.39	1.08	0.66	800	26.27	13.07	3.13
900	19.16	22.82	28.39	26.76	1.09	0.66	900	26.09	13.09	3.12
1000	19.03	22.81	28.74	26.05	1.09	0.65	1000	26.07	13.01	3.03
1100	18.86	22.74	28.65	25.52	1.10	0.64	1100	26.13	12.55	2.97
1200	18.73	22.73	28.27	25.14	1.10	0.63	1200	25.90	12.74	3.04
1300	18.57	22.68	28.66	24.78	1.11	0.62	1300	26.35	12.71	3.14
1400	18.40	22.66	28.74	24.51	1.12	0.61	1400	26.51	12.83	3.07
1500	18.25	22.60	29.24	24.45	1.12	0.60	1500	26.19	12.68	2.96
1600	18.04	22.59	29.17	24.15	1.13	0.59	1600	27.13	12.65	3.05
1800	17.70	22.53	29.56	23.99	1.15	0.57	1700	27.42	13.20	3.21
2000	17.38	22.42	30.36	24.17	1.17	0.56	1800	27.76	12.71	3.04
2200	16.98	22.33	30.23	24.05	1.19	0.54	1900	27.50	13.08	3.02
2400	16.65	22.25	31.09	24.35	1.21	0.52	2000	27.56	13.25	3.07
2600	16.29	22.16	30.66	24.50	1.23	0.51	2100	28.16	13.30	3.14
2800	15.92	22.06	31.35	24.56	1.26	0.49	2200	28.02	13.25	3.14
3000	15.60	21.92	31.26	24.92	1.27	0.48	2300	28.24	13.23	2.98
3200	15.27	21.85	30.53	25.05	1.30	0.47	2400	28.22	13.29	2.90
3400	14.93	21.74	30.77	24.67	1.32	0.46	2500	27.92	13.23	2.97
3600	14.60	21.65	28.59	24.64	1.34	0.45	2600	28.48	13.30	3.02
3800	14.29	21.61	27.59	23.91	1.37	0.43	2700	28.16	13.15	3.02
4000	13.96	21.54	26.98	23.13	1.40	0.42	2800	27.79	13.03	3.04
4500	13.14	21.49	24.68	20.86	1.49	0.39	2900	28.05	12.88	3.11
5000	12.48	21.48	21.80	19.23	1.57	0.36	3000	27.98	13.05	3.11
5500	11.96	21.57	18.98	17.93	1.65	0.34	3100	27.74	12.86	3.10
6000	11.59	21.46	16.30	18.03	1.68	0.34	3200	27.98	12.85	3.05
6500	11.34	21.44	14.19	19.02	1.70	0.33	3300	27.76	12.86	3.08
7000	11.11	21.47	12.74	19.73	1.72	0.33	3400	27.57	12.80	3.14
8000	10.60	21.10	9.91	23.59	1.66	0.31	3500	26.94	12.51	3.11
9000	9.61	20.41	7.65	19.45	1.55	0.28	3600	27.35	12.36	3.15
10000	7.91	19.67	5.82	15.08	1.48	0.24	3700	26.75	12.45	3.12
11000	5.97	18.90	4.70	11.37	1.41	0.22	3800	27.04	12.22	3.11
12000	3.90	18.15	3.93	8.31	1.28	0.22	3900	26.55	11.83	3.14
13000	1.63	18.00	3.40	6.12	1.19	0.25	4000	26.49	12.09	3.21

REV. X1

ERA-33SM+

120119

Page 2 of 11



IF/RF MICROWAVE COMPONENTS • ISO 9001 ISO 14001 AS 9100 CERTIFIED • RoHS compliant

P.O. Box 350166, Brooklyn, New York 11235-0003 (718) 934-4500 Fax (718) 332-4661



The Design Engineers Search Engine finds the model you need, Instantly • For detailed performance specs & shopping online see



Typical Performance Data

Definitions:

Input Return Loss = -S11 (dB)

Gain(Power Gain) = S21 (dB)

Reverse Isolation = -S12 (dB)

Output Return Loss = -S22 (dB)

TEST CONDITIONS: Icc = 48mA, Vd = 4.27V @Temperature = +25degC

FREQ	Gain	Isolation	Input Return Loss	Output Return Loss	Stability		FREQ	IP3 Output	1dB Comp. Output	Noise Figure
(MHz)	(dB)	(dB)	(dB)	(dB)	K	Delta	(MHz)	(dBm)	(dBm)	(dB)
50	20.42	23.47	39.71	26.99	1.06	0.70	50	31.59	16.88	3.24
100	20.41	23.47	37.71	26.26	1.06	0.70	100	31.20	16.81	3.11
200	20.34	23.46	36.10	26.10	1.06	0.70	200	31.84	16.99	3.15
300	20.29	23.41	34.63	25.90	1.06	0.70	300	32.09	16.93	3.24
400	20.20	23.40	33.24	25.00	1.07	0.69	400	31.63	16.83	3.31
500	20.11	23.37	32.09	24.64	1.07	0.69	500	31.23	16.93	3.16
600	20.00	23.36	31.43	24.08	1.07	0.68	600	31.34	16.91	3.28
700	19.89	23.34	30.55	23.67	1.08	0.67	700	32.19	16.97	3.20
800	19.78	23.30	29.93	23.09	1.08	0.67	800	32.23	16.98	3.24
900	19.62	23.29	29.43	22.68	1.08	0.65	900	32.11	16.90	3.21
1000	19.47	23.24	29.12	22.35	1.09	0.65	1000	32.05	16.94	3.13
1100	19.32	23.18	28.82	22.02	1.09	0.64	1100	32.17	16.57	3.04
1200	19.16	23.16	28.43	21.76	1.10	0.63	1200	31.77	16.87	3.09
1300	18.99	23.11	28.41	21.52	1.11	0.62	1300	31.95	16.82	3.19
1400	18.83	23.05	28.46	21.38	1.11	0.61	1400	32.07	16.85	3.15
1500	18.65	23.02	28.59	21.17	1.12	0.60	1500	31.42	16.58	3.06
1600	18.46	22.97	28.45	21.17	1.13	0.59	1600	32.58	16.45	3.14
1800	18.11	22.88	28.59	21.08	1.14	0.57	1700	32.93	16.86	3.33
2000	17.75	22.74	29.87	21.17	1.16	0.56	1800	33.24	16.41	3.17
2200	17.35	22.68	29.67	21.20	1.18	0.54	1900	32.73	16.68	3.16
2400	17.00	22.51	31.41	21.49	1.20	0.53	2000	32.69	16.61	3.19
2600	16.62	22.40	32.39	21.78	1.22	0.51	2100	32.63	16.53	3.26
2800	16.27	22.32	33.79	21.95	1.24	0.50	2200	32.40	16.28	3.23
3000	15.93	22.16	38.99	22.28	1.26	0.49	2300	32.62	15.99	3.09
3200	15.58	22.03	42.37	22.55	1.28	0.48	2400	32.63	15.97	3.00
3400	15.25	21.90	51.44	22.46	1.30	0.46	2500	32.01	15.88	3.07
3600	14.92	21.82	44.62	22.59	1.33	0.45	2600	32.09	15.86	3.12
3800	14.58	21.70	36.11	21.97	1.35	0.44	2700	31.38	15.76	3.12
4000	14.27	21.62	33.82	21.66	1.37	0.43	2800	31.10	15.47	3.17
4500	13.43	21.53	28.10	19.76	1.45	0.40	2900	31.09	15.12	3.24
5000	12.77	21.43	24.11	18.45	1.52	0.38	3000	30.80	15.07	3.23
5500	12.27	21.41	20.90	17.28	1.58	0.36	3100	30.36	14.76	3.22
6000	11.90	21.24	17.86	17.13	1.60	0.36	3200	29.82	14.59	3.17
6500	11.68	21.11	15.60	17.71	1.61	0.36	3300	29.92	14.55	3.20
7000	11.45	21.05	14.03	18.00	1.62	0.36	3400	29.61	14.50	3.26
8000	11.02	20.59	10.86	19.80	1.55	0.35	3500	29.15	14.19	3.22
9000	10.11	19.91	8.32	17.41	1.46	0.33	3600	29.19	13.96	3.27
10000	8.50	19.24	6.27	14.24	1.40	0.29	3700	28.09	14.04	3.25
11000	6.59	18.53	5.00	10.99	1.33	0.26	3800	28.06	13.76	3.26
12000	4.55	17.87	4.15	8.21	1.22	0.25	3900	27.86	13.30	3.29
13000	2.39	17.80	3.53	6.18	1.12	0.26	4000	28.05	13.52	3.35

REV. X1

ERA-33SM+

120119

Page 3 of 11



IF/RF MICROWAVE COMPONENTS • ISO 9001 ISO 14001 AS 9100 CERTIFIED • RoHS compliant

P.O. Box 350166, Brooklyn, New York 11235-0003 (718) 934-4500 Fax (718) 332-4661



The Design Engineers Search Engine finds the model you need, Instantly • For detailed performance specs & shopping online see



MMIC Amplifier

ERA-33SM+

Typical Performance Data

Definitions:

Input Return Loss = -S11 (dB)

Gain(Power Gain) = S21 (dB)

Reverse Isolation = -S12 (dB)

Output Return Loss = -S22 (dB)

TEST CONDITIONS: Icc = 40mA, Vd = 4.46V @ Temperature = -45degC

FREQ	Gain	Isolation	Input Return Loss	Output Return Loss	Stability		FREQ	IP3 Output	1dB Comp. Output	Noise Figure
(MHz)	(dB)	(dB)	(dB)	(dB)	K	Delta	(MHz)	(dBm)	(dBm)	(dB)
50	20.34	23.33	40.14	31.92	1.06	0.71	50	29.21	15.45	2.73
100	20.34	23.25	36.08	32.10	1.06	0.72	100	28.95	15.50	2.64
200	20.29	23.34	34.19	32.84	1.06	0.70	200	29.44	15.49	2.64
300	20.23	23.28	34.95	29.02	1.06	0.70	300	29.82	15.45	2.73
400	20.17	23.30	36.19	26.20	1.06	0.70	400	29.52	15.36	2.77
500	20.08	23.24	34.29	25.78	1.06	0.69	500	29.34	15.48	2.61
600	19.97	23.21	34.16	25.08	1.07	0.69	600	29.60	15.56	2.69
700	19.88	23.19	33.36	24.56	1.07	0.68	700	30.25	15.55	2.62
800	19.77	23.17	31.63	24.22	1.07	0.67	800	30.27	15.57	2.66
900	19.63	23.16	30.39	24.02	1.08	0.66	900	30.24	15.43	2.63
1000	19.48	23.13	30.36	23.53	1.08	0.66	1000	30.12	15.46	2.58
1100	19.34	23.06	30.48	22.95	1.09	0.65	1100	30.12	15.07	2.49
1200	19.18	23.05	29.30	22.56	1.09	0.64	1200	29.94	15.29	2.55
1300	19.01	23.00	28.92	22.46	1.10	0.63	1300	30.28	15.35	2.64
1400	18.87	22.94	28.84	22.45	1.10	0.62	1400	30.45	15.45	2.59
1500	18.70	22.93	28.76	22.36	1.11	0.61	1500	30.11	15.19	2.45
1600	18.51	22.85	28.87	22.09	1.12	0.60	1600	30.83	15.13	2.55
1800	18.15	22.76	28.57	21.95	1.13	0.59	1700	31.17	15.63	2.73
2000	17.82	22.63	28.83	22.25	1.15	0.57	1800	31.47	15.22	2.55
2200	17.44	22.54	29.59	21.66	1.17	0.55	1900	31.45	15.58	2.53
2400	17.09	22.40	31.25	21.90	1.18	0.54	2000	31.76	15.63	2.57
2600	16.72	22.35	34.83	21.50	1.21	0.52	2100	31.97	15.71	2.65
2800	16.39	22.21	36.71	22.12	1.23	0.51	2200	32.17	15.66	2.64
3000	16.05	22.06	38.89	22.91	1.24	0.50	2300	31.71	15.60	2.50
3200	15.70	21.97	39.58	22.84	1.27	0.48	2400	32.12	15.62	2.39
3400	15.38	21.83	50.08	22.96	1.28	0.48	2500	31.54	15.59	2.45
3600	15.05	21.76	49.77	23.14	1.31	0.46	2600	32.88	15.58	2.51
3800	14.75	21.61	38.47	22.77	1.32	0.45	2700	31.60	15.45	2.49
4000	14.39	21.55	36.93	21.77	1.35	0.44	2800	31.44	15.30	2.55
4500	13.62	21.40	29.24	19.74	1.42	0.41	2900	31.64	15.07	2.60
5000	12.93	21.42	24.74	18.00	1.50	0.38	3000	31.88	15.10	2.60
5500	12.48	21.28	20.84	17.24	1.53	0.38	3100	30.98	14.83	2.58
6000	12.12	21.14	18.70	17.27	1.56	0.37	3200	30.92	14.76	2.54
6500	11.86	21.06	16.26	17.40	1.58	0.37	3300	31.13	14.74	2.60
7000	11.70	21.00	14.34	17.66	1.58	0.37	3400	30.98	14.65	2.61
8000	11.35	20.63	11.24	20.11	1.52	0.36	3500	30.29	14.36	2.60
9000	10.56	19.83	8.80	18.67	1.42	0.35	3600	30.25	14.15	2.60
10000	9.02	19.17	6.23	13.91	1.34	0.33	3700	29.42	14.26	2.60
11000	6.98	18.60	4.76	10.35	1.25	0.28	3800	29.07	14.01	2.62
12000	5.29	17.75	4.20	8.46	1.13	0.24	3900	28.96	13.57	2.64
13000	3.38	17.35	3.34	6.37	0.95	0.27	4000	29.19	13.80	2.69

REV. X1

ERA-33SM+

120119

Page 4 of 11



IF/RF MICROWAVE COMPONENTS • ISO 9001 ISO 14001 AS 9100 CERTIFIED • RoHS compliant

P.O. Box 350166, Brooklyn, New York 11235-0003 (718) 934-4500 Fax (718) 332-4661



The Design Engineers Search Engine finds the model you need, Instantly • For detailed performance specs & shopping online see



Typical Performance Data

Definitions:

Input Return Loss = -S11 (dB)

Gain(Power Gain) = S21 (dB)

Reverse Isolation = -S12 (dB)

Output Return Loss = -S22 (dB)

TEST CONDITIONS: Icc = 32mA, Vd = 4.42V @ Temperature = -45degC

FREQ	Gain	Isolation	Input Return Loss	Output Return Loss	Stability		FREQ	IP3 Output	1dB Comp. Output	Noise Figure
(MHz)	(dB)	(dB)	(dB)	(dB)	K	Delta	(MHz)	(dBm)	(dBm)	(dB)
50	20.05	23.01	29.29	44.04	1.06	0.71	50	25.76	12.98	2.64
100	20.06	23.10	28.71	42.91	1.06	0.70	100	25.43	13.15	2.61
200	20.02	23.10	27.84	37.50	1.06	0.70	200	25.83	13.05	2.60
300	19.97	23.07	29.31	33.14	1.06	0.70	300	26.22	13.08	2.64
400	19.89	23.06	32.56	30.20	1.07	0.69	400	26.06	12.96	2.72
500	19.82	23.01	32.32	29.16	1.07	0.69	500	25.77	13.09	2.55
600	19.71	23.00	31.67	28.27	1.07	0.68	600	26.08	13.18	2.63
700	19.60	22.97	31.35	27.05	1.07	0.68	700	26.72	13.18	2.55
800	19.50	22.96	30.03	26.70	1.08	0.67	800	26.79	13.20	2.61
900	19.37	22.95	29.68	26.36	1.08	0.66	900	26.57	13.18	2.59
1000	19.24	22.91	29.62	25.53	1.09	0.65	1000	26.48	13.12	2.54
1100	19.10	22.88	29.47	24.74	1.09	0.65	1100	26.63	12.71	2.47
1200	18.94	22.82	29.04	24.34	1.10	0.64	1200	26.44	12.92	2.52
1300	18.79	22.80	29.21	24.34	1.10	0.63	1300	26.77	12.93	2.61
1400	18.64	22.74	28.98	24.32	1.11	0.62	1400	27.01	13.01	2.56
1500	18.48	22.71	29.23	24.07	1.11	0.61	1500	26.66	12.80	2.42
1600	18.30	22.65	29.34	23.72	1.12	0.60	1600	27.60	12.76	2.50
1800	17.96	22.59	28.98	23.56	1.14	0.59	1700	27.93	13.38	2.67
2000	17.63	22.45	29.85	23.88	1.15	0.57	1800	28.26	12.91	2.50
2200	17.25	22.40	31.21	23.14	1.17	0.55	1900	28.25	13.31	2.48
2400	16.93	22.24	33.82	23.41	1.19	0.54	2000	28.30	13.39	2.53
2600	16.56	22.20	37.25	22.81	1.21	0.52	2100	28.62	13.46	2.58
2800	16.22	22.10	36.49	23.55	1.23	0.51	2200	28.66	13.48	2.59
3000	15.90	21.96	35.34	24.38	1.25	0.50	2300	28.78	13.54	2.44
3200	15.54	21.90	35.72	24.19	1.28	0.48	2400	29.15	13.63	2.36
3400	15.23	21.72	37.11	24.36	1.29	0.47	2500	29.00	13.67	2.42
3600	14.89	21.68	34.62	24.23	1.32	0.46	2600	29.02	13.70	2.48
3800	14.59	21.56	31.84	23.78	1.34	0.45	2700	28.61	13.61	2.44
4000	14.23	21.55	31.45	22.56	1.37	0.43	2800	28.66	13.45	2.49
4500	13.48	21.40	27.74	20.26	1.44	0.41	2900	29.00	13.35	2.53
5000	12.79	21.42	23.83	18.41	1.52	0.38	3000	28.91	13.50	2.55
5500	12.33	21.33	19.94	17.70	1.56	0.37	3100	28.93	13.44	2.53
6000	11.97	21.22	17.84	17.77	1.59	0.36	3200	29.10	13.49	2.49
6500	11.72	21.22	15.47	17.97	1.62	0.36	3300	28.70	13.57	2.52
7000	11.53	21.19	13.67	18.43	1.62	0.35	3400	28.90	13.48	2.57
8000	11.16	20.88	10.69	21.87	1.57	0.34	3500	28.42	13.21	2.53
9000	10.33	20.09	8.38	19.88	1.46	0.33	3600	28.46	13.03	2.56
10000	8.77	19.39	5.99	14.48	1.37	0.31	3700	27.95	13.23	2.55
11000	6.69	18.80	4.60	10.58	1.28	0.26	3800	27.69	13.02	2.56
12000	4.99	17.87	4.09	8.53	1.15	0.23	3900	27.56	12.65	2.57
13000	3.03	17.47	3.26	6.37	0.97	0.26	4000	27.56	12.87	2.60

REV. X1

ERA-33SM+

120119

Page 5 of 11



IF/RF MICROWAVE COMPONENTS • ISO 9001 ISO 14001 AS 9100 CERTIFIED • RoHS compliant

P.O. Box 350166, Brooklyn, New York 11235-0003 (718) 934-4500 Fax (718) 332-4661



The Design Engineers Search Engine finds the model you need, Instantly • For detailed performance specs & shopping online see



Typical Performance Data

Definitions:

Input Return Loss = -S11 (dB)

Gain(Power Gain) = S21 (dB)

Reverse Isolation = -S12 (dB)

Output Return Loss = -S22 (dB)

TEST CONDITIONS: Icc = 48mA, Vd = 4.49V @ Temperature = -45degC

FREQ	Gain	Isolation	Input Return Loss	Output Return Loss	Stability		FREQ	IP3 Output	1dB Comp. Output	Noise Figure
(MHz)	(dB)	(dB)	(dB)	(dB)	K	Delta	(MHz)	(dBm)	(dBm)	(dB)
50	20.52	23.22	40.19	26.82	1.05	0.73	50	32.15	17.20	2.83
100	20.52	23.44	43.59	27.46	1.06	0.71	100	31.60	17.14	2.70
200	20.47	23.45	37.71	27.86	1.06	0.71	200	32.35	17.22	2.70
300	20.40	23.42	34.27	25.74	1.06	0.71	300	32.57	17.18	2.76
400	20.34	23.46	32.14	23.90	1.06	0.70	400	32.45	17.10	2.82
500	20.25	23.42	31.06	23.50	1.06	0.69	500	32.13	17.23	2.68
600	20.14	23.43	30.93	23.17	1.07	0.69	600	32.21	17.22	2.76
700	20.04	23.37	30.82	22.80	1.07	0.68	700	33.23	17.28	2.67
800	19.93	23.36	29.76	22.65	1.07	0.67	800	32.99	17.26	2.71
900	19.79	23.34	28.78	22.50	1.08	0.66	900	33.13	17.13	2.70
1000	19.64	23.26	28.74	22.13	1.08	0.66	1000	32.90	17.18	2.64
1100	19.49	23.24	28.95	21.74	1.09	0.65	1100	32.81	16.82	2.54
1200	19.34	23.20	28.00	21.41	1.09	0.64	1200	32.79	17.12	2.58
1300	19.16	23.16	27.50	21.27	1.10	0.63	1300	33.59	17.11	2.67
1400	19.01	23.07	27.39	21.36	1.10	0.62	1400	33.16	17.15	2.63
1500	18.84	23.07	27.36	21.24	1.11	0.61	1500	32.80	16.89	2.52
1600	18.65	22.99	27.40	21.03	1.12	0.60	1600	33.34	16.78	2.62
1800	18.29	22.90	27.17	20.94	1.13	0.58	1700	33.81	17.23	2.78
2000	17.95	22.75	27.32	21.20	1.15	0.57	1800	34.47	16.84	2.63
2200	17.57	22.66	27.61	20.73	1.16	0.55	1900	34.00	17.16	2.59
2400	17.21	22.51	28.65	20.95	1.18	0.54	2000	34.04	17.15	2.65
2600	16.84	22.41	31.20	20.69	1.20	0.53	2100	33.96	17.13	2.70
2800	16.51	22.27	32.63	21.29	1.22	0.51	2200	34.01	16.96	2.69
3000	16.17	22.14	34.37	21.99	1.24	0.50	2300	34.17	16.72	2.54
3200	15.81	22.05	34.61	22.07	1.26	0.49	2400	34.28	16.69	2.44
3400	15.50	21.88	35.70	22.21	1.28	0.48	2500	33.35	16.64	2.52
3600	15.16	21.82	40.30	22.44	1.30	0.46	2600	34.02	16.64	2.57
3800	14.85	21.66	39.62	22.13	1.32	0.46	2700	33.46	16.53	2.56
4000	14.50	21.60	37.49	21.30	1.35	0.44	2800	33.41	16.32	2.60
4500	13.72	21.42	29.31	19.42	1.41	0.41	2900	33.11	15.99	2.67
5000	13.04	21.39	24.93	17.74	1.48	0.39	3000	32.74	15.95	2.68
5500	12.59	21.20	21.42	16.98	1.51	0.38	3100	32.12	15.64	2.67
6000	12.23	21.04	19.39	16.89	1.53	0.38	3200	31.74	15.47	2.61
6500	11.98	20.98	16.90	16.98	1.55	0.38	3300	31.50	15.47	2.65
7000	11.83	20.85	14.96	17.12	1.54	0.38	3400	31.31	15.36	2.69
8000	11.51	20.45	11.76	18.86	1.49	0.38	3500	30.97	15.07	2.64
9000	10.77	19.65	9.19	17.61	1.39	0.37	3600	30.39	14.89	2.65
10000	9.25	18.97	6.47	13.30	1.31	0.35	3700	30.26	14.92	2.65
11000	7.24	18.45	4.92	10.10	1.22	0.31	3800	29.50	14.71	2.68
12000	5.55	17.62	4.34	8.36	1.11	0.26	3900	29.27	14.26	2.72
13000	3.68	17.25	3.43	6.32	0.93	0.28	4000	29.57	14.44	2.76

REV. X1

ERA-33SM+

120119

Page 6 of 11



IF/RF MICROWAVE COMPONENTS • ISO 9001 ISO 14001 AS 9100 CERTIFIED • RoHS compliant

P.O. Box 350166, Brooklyn, New York 11235-0003 (718) 934-4500 Fax (718) 332-4661



The Design Engineers Search Engine finds the model you need, Instantly • For detailed performance specs & shopping online see



Typical Performance Data

Definitions:

Input Return Loss = -S11 (dB)

Gain(Power Gain) = S21 (dB)

Reverse Isolation = -S12 (dB)

Output Return Loss = -S22 (dB)

TEST CONDITIONS: Icc = 40mA, Vd = 4.05V @ Temperature = +85degC

FREQ	Gain	Isolation	Input Return Loss	Output Return Loss	Stability		FREQ	IP3 Output	1dB Comp. Output	Noise Figure
(MHz)	(dB)	(dB)	(dB)	(dB)	K	Delta	(MHz)	(dBm)	(dBm)	(dB)
50	20.04	23.20	36.22	37.72	1.07	0.69	50	28.21	15.28	3.58
100	20.03	23.13	39.22	32.15	1.06	0.70	100	27.99	15.19	3.51
200	19.96	23.07	41.74	29.16	1.06	0.70	200	28.55	15.33	3.54
300	19.89	23.08	38.72	29.37	1.07	0.69	300	28.81	15.31	3.64
400	19.83	23.07	35.81	29.68	1.07	0.69	400	28.53	15.07	3.73
500	19.73	23.12	32.75	29.25	1.07	0.68	500	28.01	15.21	3.57
600	19.61	23.05	32.16	27.84	1.08	0.67	600	28.32	15.26	3.69
700	19.51	23.02	31.65	26.93	1.08	0.67	700	28.93	15.26	3.60
800	19.40	23.01	30.34	26.51	1.08	0.66	800	29.00	15.30	3.65
900	19.25	22.98	29.48	25.96	1.09	0.65	900	28.77	15.15	3.63
1000	19.08	22.95	28.73	25.42	1.10	0.64	1000	28.77	15.16	3.55
1100	18.94	22.93	28.39	24.95	1.10	0.63	1100	28.80	14.84	3.47
1200	18.78	22.89	27.84	24.38	1.11	0.62	1200	28.62	15.05	3.53
1300	18.60	22.84	27.75	24.19	1.11	0.61	1300	29.00	15.04	3.64
1400	18.45	22.81	27.67	23.98	1.12	0.60	1400	29.04	15.17	3.62
1500	18.27	22.76	28.25	23.61	1.13	0.59	1500	28.55	14.88	3.51
1600	18.07	22.71	28.22	23.29	1.14	0.58	1600	29.51	14.75	3.60
1800	17.70	22.63	28.78	22.94	1.16	0.56	1700	29.94	15.18	3.77
2000	17.35	22.49	30.69	22.79	1.17	0.55	1800	30.37	14.77	3.60
2200	16.96	22.44	31.75	22.42	1.20	0.53	1900	29.86	15.07	3.59
2400	16.60	22.33	33.39	22.64	1.22	0.52	2000	29.60	15.09	3.64
2600	16.22	22.26	33.88	22.75	1.25	0.50	2100	29.67	15.04	3.72
2800	15.87	22.16	34.31	23.13	1.27	0.48	2200	29.88	14.79	3.70
3000	15.51	22.04	32.47	23.84	1.29	0.47	2300	30.18	14.60	3.55
3200	15.16	21.93	31.82	23.99	1.31	0.46	2400	29.65	14.58	3.44
3400	14.82	21.83	31.05	24.31	1.34	0.45	2500	29.10	14.42	3.52
3600	14.48	21.78	30.06	24.41	1.37	0.43	2600	29.73	14.36	3.58
3800	14.17	21.65	28.96	23.96	1.39	0.42	2700	28.83	14.25	3.58
4000	13.80	21.62	28.17	22.86	1.43	0.41	2800	28.57	13.94	3.64
4500	13.01	21.53	24.47	20.68	1.51	0.38	2900	28.51	13.62	3.72
5000	12.31	21.56	21.19	18.63	1.60	0.35	3000	28.33	13.60	3.68
5500	11.77	21.49	17.83	17.71	1.66	0.34	3100	27.63	13.30	3.66
6000	11.39	21.43	15.49	17.95	1.70	0.34	3200	27.35	13.10	3.63
6500	11.10	21.55	14.05	19.43	1.75	0.32	3300	26.59	13.11	3.67
7000	10.86	21.49	12.44	21.30	1.76	0.31	3400	27.15	13.08	3.73
8000	10.32	21.21	9.81	25.76	1.71	0.29	3500	26.55	12.70	3.69
9000	9.08	20.49	7.43	18.23	1.63	0.26	3600	26.73	12.45	3.74
10000	7.25	19.76	5.78	14.49	1.58	0.22	3700	26.08	12.50	3.73
11000	5.40	18.85	4.91	11.51	1.51	0.19	3800	25.69	12.27	3.74
12000	3.26	18.24	4.07	8.22	1.42	0.22	3900	25.86	11.80	3.76
13000	0.78	18.08	3.42	6.01	1.31	0.25	4000	25.53	12.02	3.81

REV. X1

ERA-33SM+

120119

Page 7 of 11



IF/RF MICROWAVE COMPONENTS • ISO 9001 ISO 14001 AS 9100 CERTIFIED • RoHS compliant

P.O. Box 350166, Brooklyn, New York 11235-0003 (718) 934-4500 Fax (718) 332-4661



The Design Engineers Search Engine finds the model you need, Instantly • For detailed performance specs & shopping online see



Typical Performance Data

Definitions:

Input Return Loss = -S11 (dB)

Gain(Power Gain) = S21 (dB)

Reverse Isolation = -S12 (dB)

Output Return Loss = -S22 (dB)

TEST CONDITIONS: Icc = 32mA, Vd = 4.01V @Temperature = +85degC

FREQ	Gain	Isolation	Input Return Loss	Output Return Loss	Stability		FREQ	IP3 Output	1dB Comp. Output	Noise Figure
(MHz)	(dB)	(dB)	(dB)	(dB)	K	Delta	(MHz)	(dBm)	(dBm)	(dB)
50	19.66	22.75	26.80	32.61	1.06	0.70	50	25.08	12.86	3.50
100	19.65	22.87	27.81	35.99	1.07	0.69	100	24.78	12.92	3.45
200	19.61	22.78	29.88	36.88	1.07	0.69	200	25.38	12.99	3.50
300	19.54	22.83	28.81	34.09	1.07	0.68	300	25.54	12.95	3.60
400	19.46	22.81	28.08	32.33	1.07	0.68	400	25.25	12.80	3.65
500	19.38	22.83	26.68	30.28	1.08	0.67	500	24.93	12.86	3.49
600	19.27	22.73	26.92	28.82	1.08	0.67	600	25.13	12.97	3.61
700	19.19	22.76	26.91	28.01	1.08	0.66	700	25.76	12.98	3.54
800	19.06	22.72	26.39	27.55	1.09	0.66	800	25.73	12.96	3.59
900	18.93	22.70	25.92	26.98	1.09	0.65	900	25.70	12.95	3.58
1000	18.78	22.68	25.54	26.22	1.10	0.64	1000	25.52	12.88	3.50
1100	18.62	22.65	25.56	25.83	1.11	0.63	1100	25.65	12.42	3.43
1200	18.48	22.63	25.36	25.50	1.11	0.62	1200	25.46	12.53	3.50
1300	18.31	22.57	25.28	25.36	1.12	0.61	1300	25.80	12.57	3.61
1400	18.16	22.54	25.43	25.24	1.13	0.60	1400	26.01	12.79	3.57
1500	18.00	22.54	25.95	25.11	1.13	0.59	1500	25.47	12.59	3.47
1600	17.81	22.49	26.05	24.78	1.14	0.58	1600	26.49	12.49	3.52
1800	17.45	22.43	26.60	24.60	1.16	0.56	1700	26.73	13.10	3.69
2000	17.11	22.31	27.68	24.56	1.18	0.55	1800	27.31	12.69	3.53
2200	16.72	22.27	28.58	24.26	1.21	0.53	1900	27.00	13.06	3.52
2400	16.37	22.11	28.70	24.59	1.22	0.52	2000	27.04	13.16	3.57
2600	16.01	22.08	28.42	24.49	1.25	0.50	2100	27.42	13.23	3.65
2800	15.65	22.00	28.42	24.99	1.28	0.48	2200	27.41	13.11	3.63
3000	15.31	21.86	27.10	25.82	1.29	0.47	2300	27.90	13.02	3.49
3200	14.95	21.81	26.89	25.77	1.32	0.45	2400	27.66	13.04	3.39
3400	14.63	21.70	26.72	25.98	1.35	0.44	2500	27.28	12.89	3.47
3600	14.28	21.71	25.76	25.69	1.38	0.43	2600	27.72	12.93	3.53
3800	13.97	21.55	25.12	25.25	1.40	0.42	2700	27.08	12.82	3.52
4000	13.62	21.55	24.70	23.74	1.44	0.40	2800	26.74	12.60	3.57
4500	12.83	21.50	22.34	21.29	1.53	0.38	2900	26.85	12.48	3.62
5000	12.13	21.59	19.74	19.08	1.63	0.35	3000	27.06	12.50	3.59
5500	11.58	21.58	16.94	18.24	1.70	0.33	3100	26.32	12.29	3.60
6000	11.20	21.58	14.71	18.68	1.75	0.32	3200	26.56	12.20	3.56
6500	10.89	21.73	13.32	20.47	1.81	0.31	3300	26.63	12.15	3.60
7000	10.65	21.77	11.85	22.87	1.83	0.30	3400	26.08	12.10	3.66
8000	10.08	21.53	9.36	29.62	1.79	0.27	3500	25.83	11.82	3.66
9000	8.79	20.79	7.14	18.82	1.69	0.24	3600	25.55	11.57	3.67
10000	6.93	19.99	5.59	14.57	1.63	0.19	3700	25.14	11.67	3.66
11000	5.07	19.05	4.79	11.50	1.57	0.17	3800	25.15	11.47	3.66
12000	2.90	18.37	3.99	8.19	1.46	0.21	3900	24.88	11.06	3.68
13000	0.36	18.16	3.37	5.91	1.36	0.26	4000	24.75	11.24	3.74

REV. X1

ERA-33SM+

120119

Page 8 of 11



IF/RF MICROWAVE COMPONENTS • ISO 9001 ISO 14001 AS 9100 CERTIFIED RoHS compliant

P.O. Box 350166, Brooklyn, New York 11235-0003 (718) 934-4500 Fax (718) 332-4661



The Design Engineers Search Engine finds the model you need, Instantly • For detailed performance specs & shopping online see



Typical Performance Data

Definitions:

Input Return Loss = -S11 (dB)

Gain(Power Gain) = S21 (dB)

Reverse Isolation = -S12 (dB)

Output Return Loss = -S22 (dB)

TEST CONDITIONS: Icc = 48mA, Vd = 4.09V @ Temperature = +85degC

FREQ	Gain	Isolation	Input Return Loss	Output Return Loss	Stability		FREQ	IP3 Output	1dB Comp. Output	Noise Figure
(MHz)	(dB)	(dB)	(dB)	(dB)	K	Delta	(MHz)	(dBm)	(dBm)	(dB)
50	20.28	23.31	39.10	28.09	1.06	0.71	50	31.20	16.60	3.69
100	20.27	23.46	35.91	26.29	1.07	0.69	100	31.04	16.48	3.55
200	20.19	23.34	32.76	25.10	1.07	0.70	200	31.64	16.72	3.61
300	20.12	23.31	33.36	25.25	1.07	0.69	300	31.77	16.67	3.69
400	20.05	23.32	33.68	25.69	1.07	0.69	400	31.39	16.56	3.79
500	19.94	23.27	32.82	25.91	1.07	0.68	500	30.90	16.65	3.66
600	19.83	23.26	32.32	25.08	1.08	0.67	600	31.07	16.60	3.76
700	19.72	23.24	31.48	24.65	1.08	0.67	700	31.68	16.60	3.67
800	19.60	23.22	30.76	24.21	1.08	0.66	800	31.71	16.61	3.72
900	19.44	23.18	29.89	24.08	1.09	0.65	900	31.38	16.54	3.68
1000	19.28	23.14	29.21	23.68	1.09	0.64	1000	31.05	16.62	3.62
1100	19.13	23.11	28.90	23.26	1.10	0.63	1100	31.44	16.25	3.52
1200	18.95	23.07	28.17	22.99	1.11	0.62	1200	30.73	16.54	3.58
1300	18.78	23.04	28.05	22.76	1.11	0.61	1300	30.95	16.49	3.71
1400	18.62	22.99	27.92	22.54	1.12	0.60	1400	31.03	16.48	3.66
1500	18.44	22.94	28.29	22.31	1.13	0.59	1500	29.95	16.16	3.57
1600	18.25	22.88	28.13	22.00	1.14	0.58	1600	31.02	15.95	3.67
1800	17.88	22.80	28.52	21.67	1.15	0.56	1700	31.48	16.30	3.84
2000	17.50	22.66	30.46	21.59	1.17	0.55	1800	31.04	15.84	3.66
2200	17.11	22.57	31.10	21.25	1.19	0.53	1900	30.66	16.06	3.64
2400	16.75	22.44	33.89	21.45	1.21	0.52	2000	30.43	15.94	3.72
2600	16.36	22.37	35.56	21.63	1.24	0.50	2100	30.23	15.82	3.79
2800	16.00	22.25	38.45	21.94	1.26	0.49	2200	29.48	15.52	3.74
3000	15.66	22.10	39.08	22.62	1.28	0.48	2300	29.48	15.20	3.61
3200	15.28	22.03	37.98	22.83	1.31	0.46	2400	29.36	15.17	3.51
3400	14.96	21.91	37.48	23.30	1.33	0.45	2500	28.87	15.06	3.57
3600	14.61	21.83	34.81	23.51	1.36	0.44	2600	29.08	15.00	3.64
3800	14.28	21.72	32.61	23.11	1.38	0.43	2700	28.49	14.89	3.66
4000	13.94	21.67	31.45	22.22	1.42	0.41	2800	27.97	14.57	3.71
4500	13.13	21.56	25.97	20.28	1.50	0.38	2900	28.19	14.18	3.78
5000	12.43	21.54	22.13	18.34	1.58	0.36	3000	27.76	14.17	3.77
5500	11.90	21.42	18.56	17.38	1.63	0.35	3100	27.06	13.80	3.76
6000	11.52	21.34	16.07	17.56	1.67	0.34	3200	27.01	13.60	3.69
6500	11.24	21.41	14.61	18.79	1.71	0.33	3300	26.44	13.60	3.75
7000	11.01	21.34	12.90	20.42	1.72	0.32	3400	26.42	13.54	3.83
8000	10.51	21.00	10.18	23.87	1.67	0.31	3500	25.39	13.18	3.78
9000	9.29	20.31	7.66	17.63	1.58	0.28	3600	26.19	12.95	3.83
10000	7.50	19.58	5.96	14.30	1.54	0.24	3700	25.27	12.97	3.80
11000	5.64	18.70	5.02	11.42	1.48	0.21	3800	25.20	12.73	3.85
12000	3.52	18.11	4.15	8.18	1.38	0.23	3900	24.75	12.28	3.88
13000	1.07	18.03	3.46	6.06	1.28	0.25	4000	24.78	12.45	3.94

REV. X1

ERA-33SM+

120119

Page 9 of 11



IF/RF MICROWAVE COMPONENTS • ISO 9001 ISO 14001 AS 9100 CERTIFIED RoHS compliant

P.O. Box 350166, Brooklyn, New York 11235-0003 (718) 934-4500 Fax (718) 332-4661



The Design Engineers Search Engine finds the model you need, Instantly • For detailed performance specs & shopping online see



Typical Performance Curves

GAIN vs. TEMPERATURE

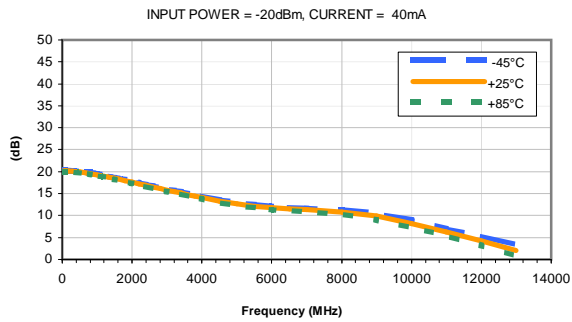

GAIN vs. CURRENT

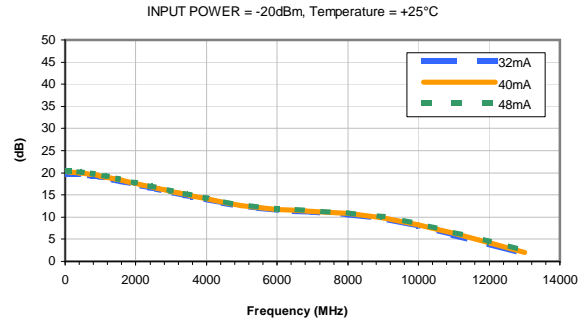

ISOLATION vs. TEMPERATURE

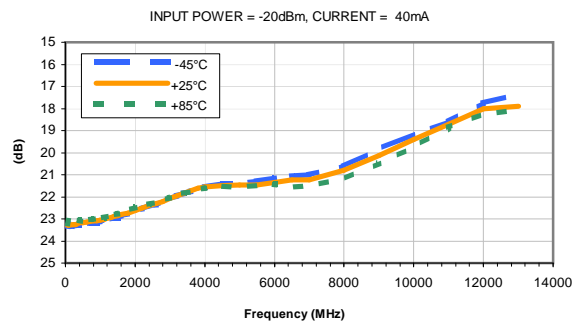

ISOLATION vs. CURRENT

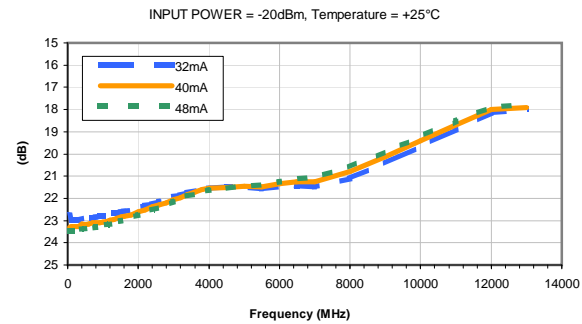

INPUT RETURN LOSS vs. TEMPERATURE

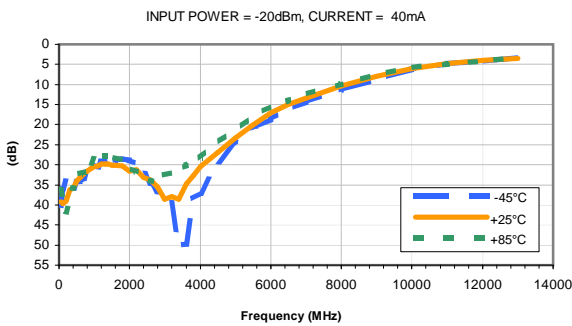

INPUT RETURN LOSS vs. CURRENT

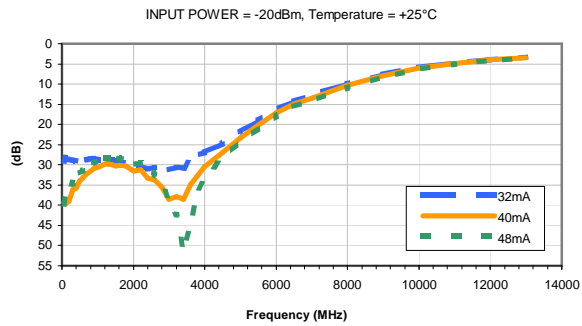

OUTPUT RETURN LOSS vs. TEMPERATURE

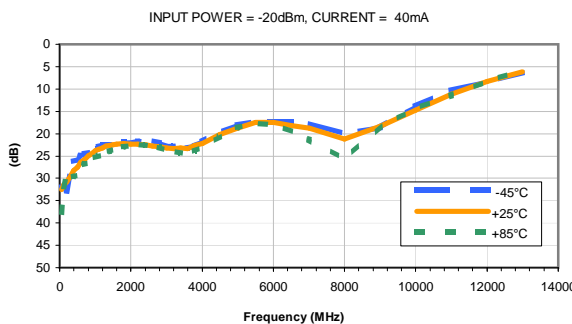

OUTPUT RETURN LOSS vs. CURRENT

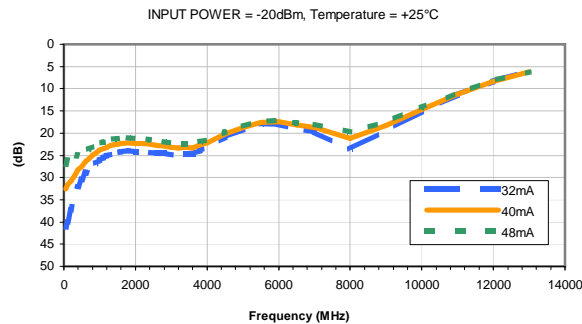

Typical Performance Curves

OUTPUT IP3 vs. TEMPERATURE

INPUT POWER = -20dBm, CURRENT = 40mA

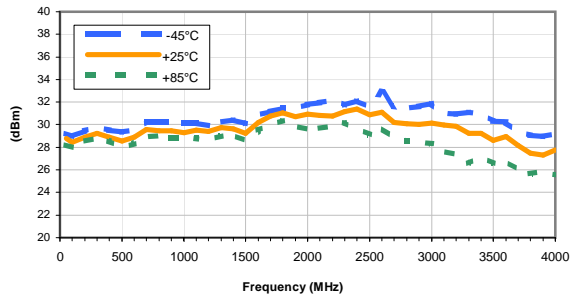

OUTPUT IP3 vs. CURRENT

INPUT POWER = -20dBm, Temperature = +25°C

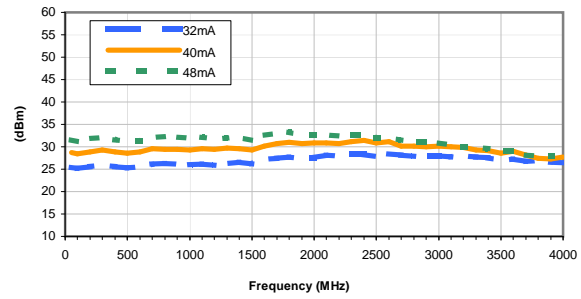

OUTPUT POWER at 1dB Compression vs. TEMPERATURE

CURRENT = 40mA

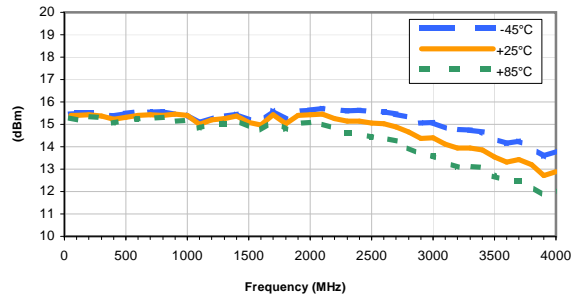

OUTPUT POWER at 1dB Compression vs. CURRENT

Temperature = +25°C

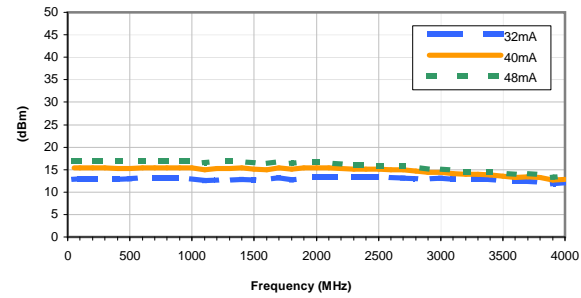

Noise Figure vs. TEMPERATURE

CURRENT = 40mA

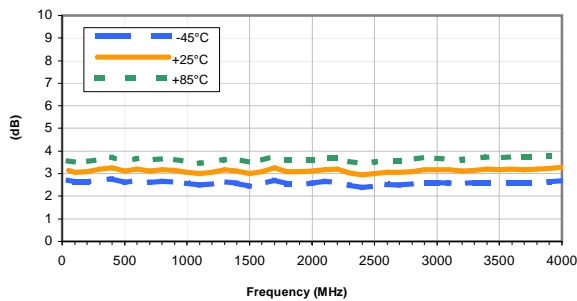

Noise Figure vs. CURRENT

Temperature = +25°C

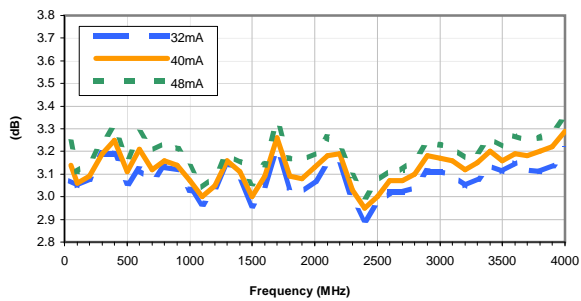

Typical Performance Curves

GAIN vs. TEMPERATURE

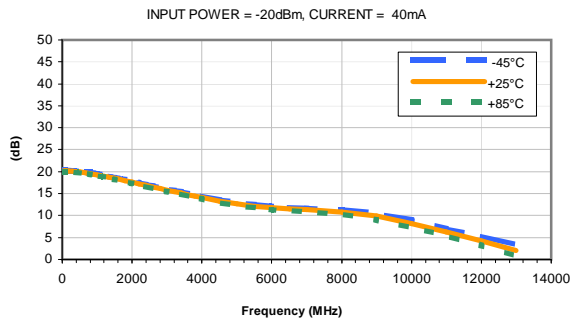

GAIN vs. CURRENT

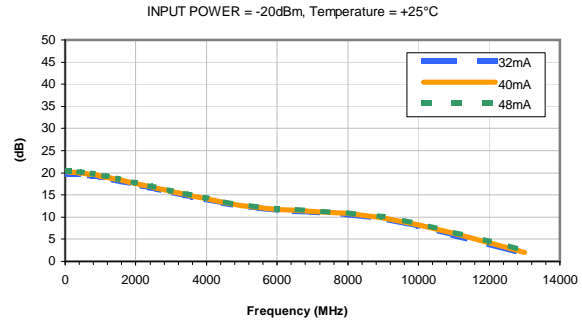

ISOLATION vs. TEMPERATURE

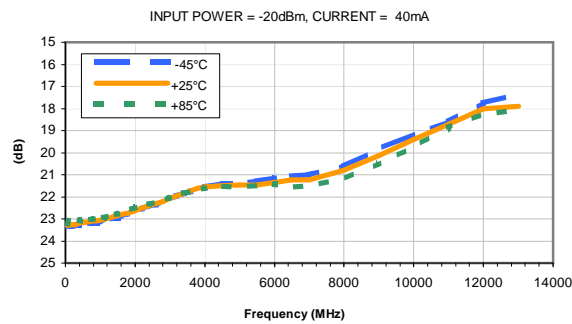

ISOLATION vs. CURRENT

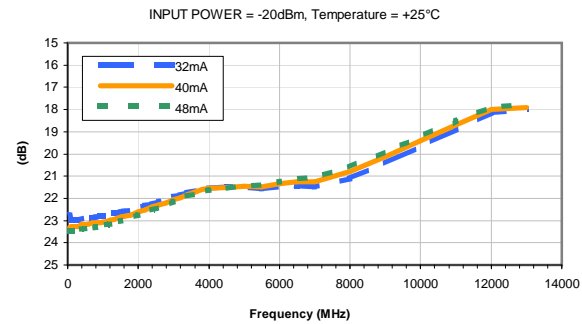

INPUT RETURN LOSS vs. TEMPERATURE

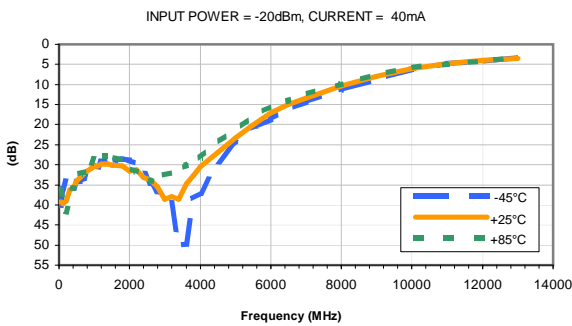

INPUT RETURN LOSS vs. CURRENT

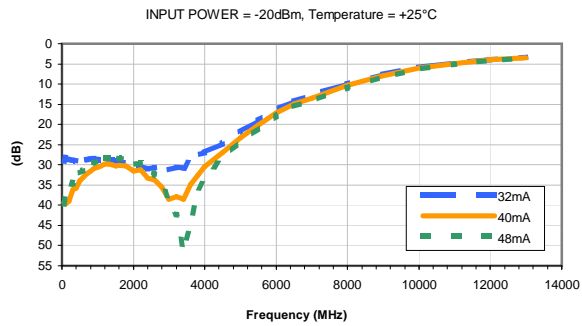

OUTPUT RETURN LOSS vs. TEMPERATURE

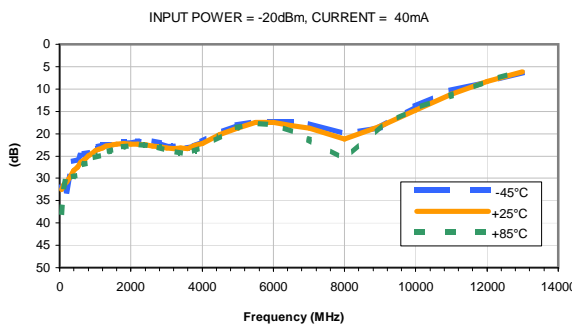

OUTPUT RETURN LOSS vs. CURRENT

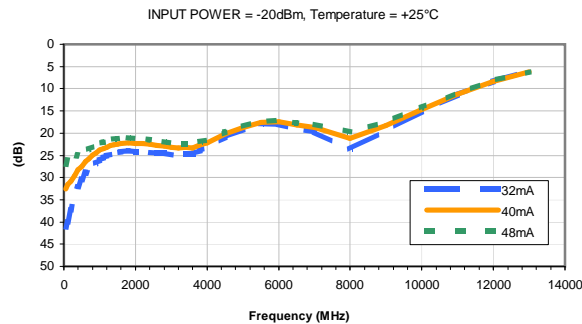

Typical Performance Curves

OUTPUT IP3 vs. TEMPERATURE

INPUT POWER = -20dBm, CURRENT = 40mA

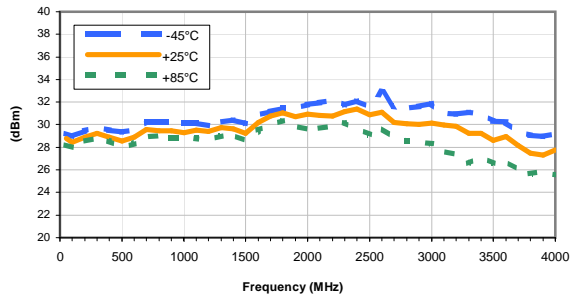

OUTPUT IP3 vs. CURRENT

INPUT POWER = -20dBm, Temperature = +25°C

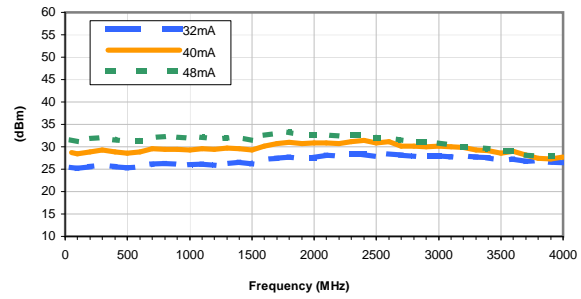

OUTPUT POWER at 1dB Compression vs. TEMPERATURE

CURRENT = 40mA

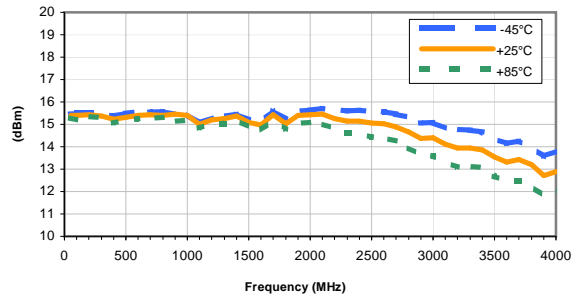

OUTPUT POWER at 1dB Compression vs. CURRENT

Temperature = +25°C

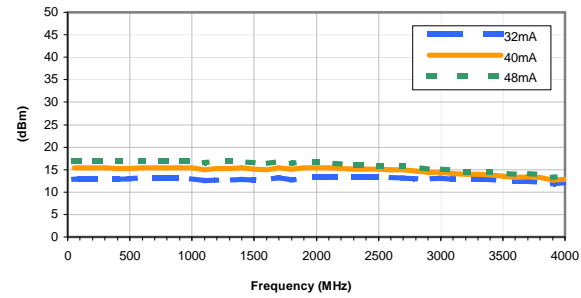

Noise Figure vs. TEMPERATURE

CURRENT = 40mA

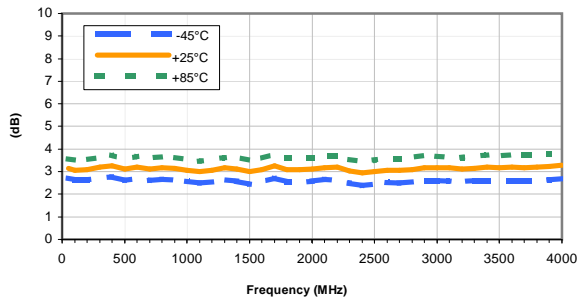

Noise Figure vs. CURRENT

Temperature = +25°C

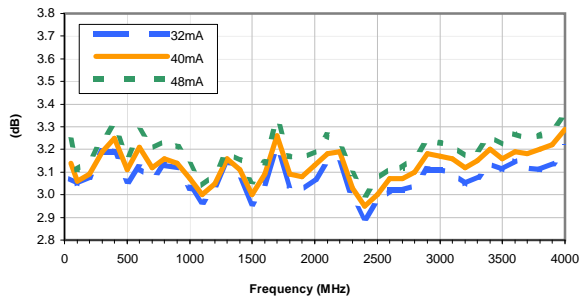

Outline Dimensions

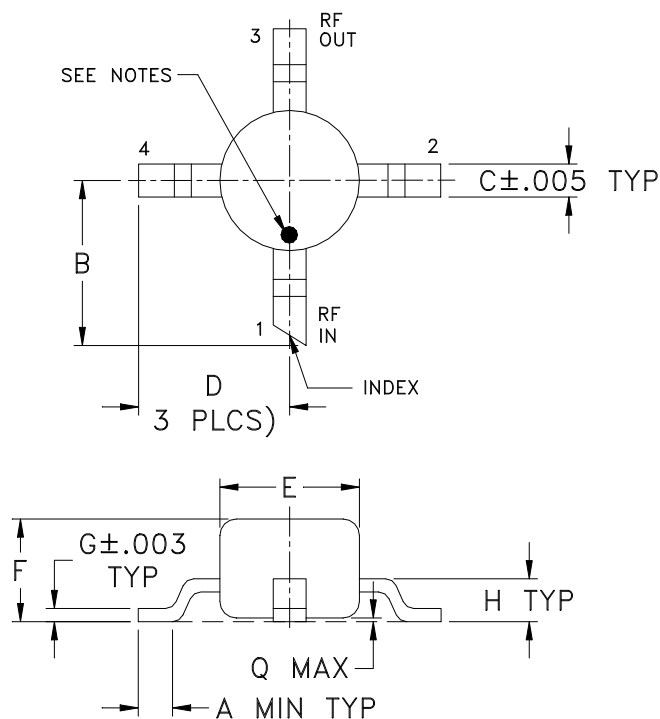

PCB Land Pattern

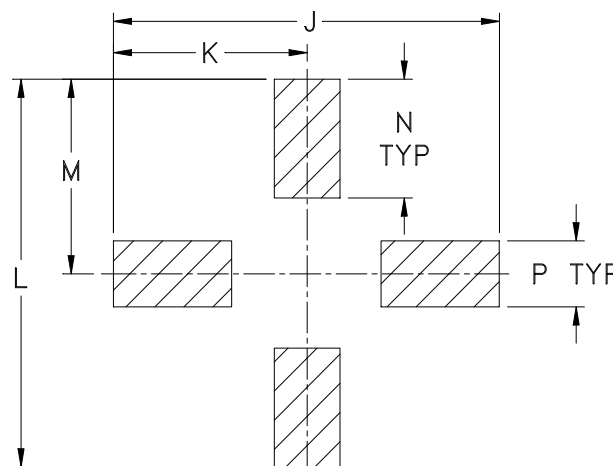

Suggested Layout,
Tolerance to be within $\pm .002$

CASE#	A	B	C	D	E	F	G	H	J	K	L	M	N	P	Q	WT. GRAMS
WW107	.012 (0.30)	.10 (2.54)	.020 (0.51)	.092 (2.34)	.085 (2.16)	.060 (1.52)	.007 (0.18)	.026 (0.66)	.235 (5.97)	.118 (3.00)	.235 (5.97)	.118 (3.00)	.072 (1.83)	.040 (1.02)	.020 (0.51)	.015

Dimensions are in inches (mm). Tolerances: 2 Pl. $\pm .03$; 3 Pl. $\pm .015$

Notes:

- Case material: Plastic.
- Termination finish:
For RoHS Case Styles: Matte tin Plate.
For RoHS-5 Case Styles: Tin-Lead plate.
- RF input termination (1) identified by one or both of the following at factory option:
 - diagonally cut termination, which may be 45° (ref) in either direction;
 - orientation mark on the case. Model dash number is identified by color dot or alphanumeric code on case. See specification data sheet.

Mini-Circuits[®]

INTERNET <http://www.minicircuits.com>

P.O. Box 350166, Brooklyn, New York 11235-0003 (718) 934-4500

Distribution Centers NORTH AMERICA 800-654-7949 • 417-335-5935 • Fax 417-335-5945 • EUROPE 44-1252-1

Mini-Circuits ISO 9001 & ISO 14001 Certified

Tape & Reel Packaging TR-F4

DEVICE ORIENTATION IN T&R

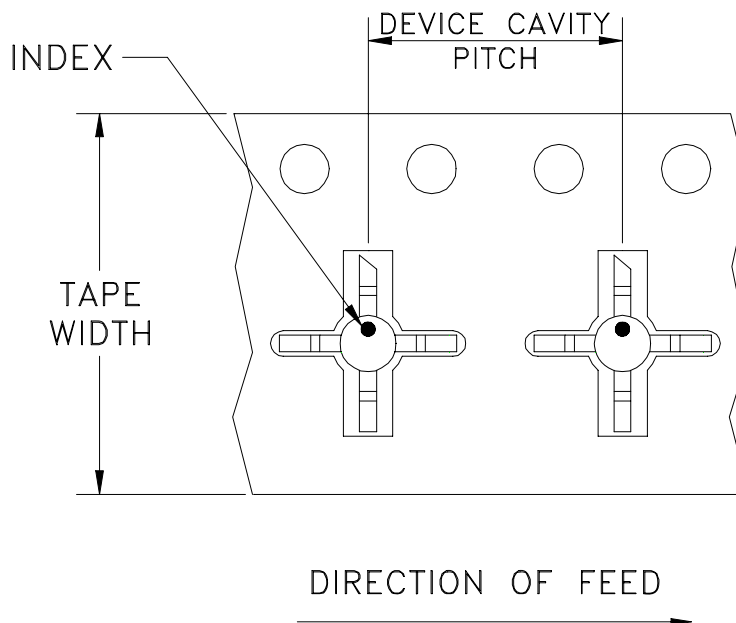

Tape Width, mm	Device Cavity Pitch, mm	Reel Size, inches	Devices per Reel	
12	8	7	Small quantity standards (see note)	20
				50
				100
				200
				500
		7	Standard	1000

Note: Please Consult individual model data sheet to determine device per reel availability.

Mini-Circuits carrier tape materials provide protection from ESD (Electro-Static Discharge) during handling and transportation. Tapes are static dissipative and comply with industry standards EIA-481/EIA-541.

Go to: www.minicircuits.com/pages/pdfs/tape.pdf



INTERNET <http://www.minicircuits.com>

P.O. Box 350166, Brooklyn, New York 11235-0003 (718) 934-4500 Fax (718) 332-4661

Distribution Centers NORTH AMERICA 800-654-7949 • 417-335-5935 • Fax 417-335-5945 • EUROPE 44-1252-832600 • Fax 44-1252-837010

Mini-Circuits ISO 9001 & ISO 14001 Certified

THIRD ANGLE PROJECTION

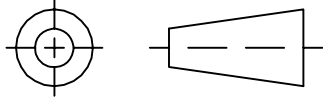

REVISIONS

REV	ECN No.	DESCRIPTION	DATE	DR	AUTH
A	M100215	ADDED "PACKAGE OUTLINE" & UPDATED NOTES	08/12/05	MMG	MM
B	M100944	REMOVED AF190 & UPDATED NOTES	09/23/05	GT	MM
C	M102713	ADDED "...WITH SMOBC"	01/14/06	GF	IL
D	M108434	UPDATED DRAWING PER TB-408+	11/14/06	PW	IG

SUGGESTED MOUNTING CONFIGURATION FOR
WW107 CASE STYLE, "cb" PIN CONNECTION

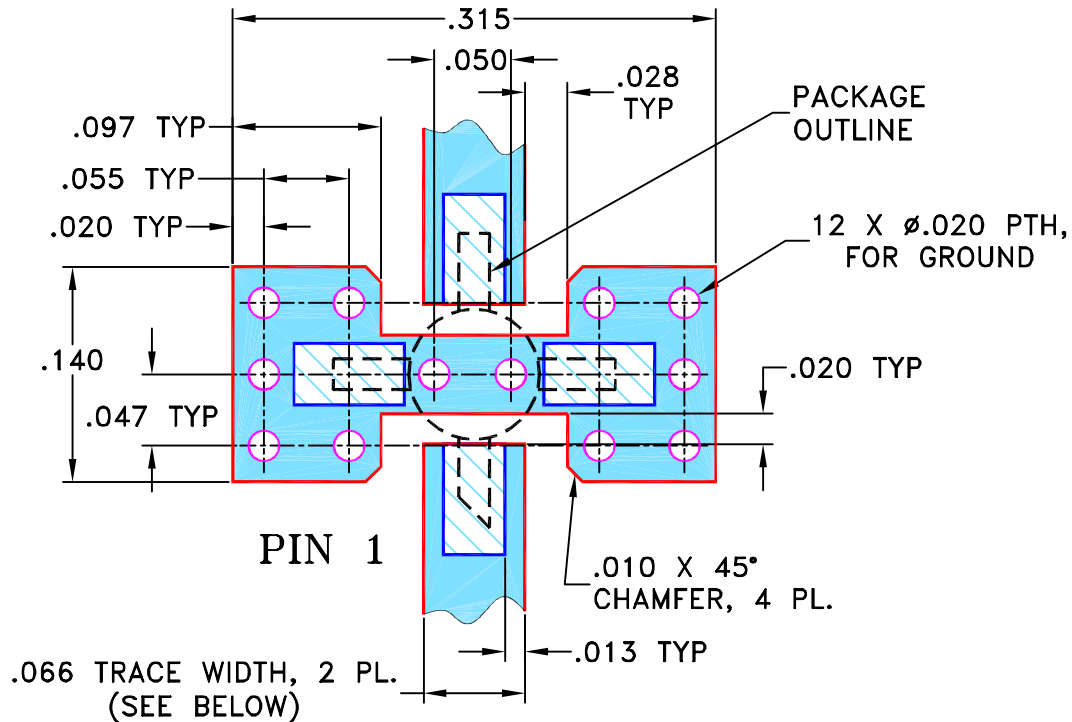

NOTES:

1. TRACE WIDTH IS SHOWN FOR ROGERS R04350B WITH DIELECTRIC THICKNESS $.030'' \pm .002''$; COPPER: 1/2 OZ. EACH SIDE. FOR OTHER MATERIALS TRACE WIDTH MAY NEED TO BE MODIFIED.
2. BOTTOM SIDE OF THE PCB IS CONTINUOUS GROUND PLANE.
3. IF PCB DESIGN RULES ALLOW, PLACE GROUND VIAS UNDER THE LAND PATTERN FOR BETTER RF PERFORMANCE. OTHERWISE PLACE GROUND VIAS AS CLOSE TO LAND PATTERN AS POSSIBLE.

- DENOTES PCB COPPER LAYOUT WITH SMOBC (SOLDER MASK OVER BARE COPPER)
- DENOTES COPPER LAND PATTERN FREE OF SOLDER MASK

UNLESS OTHERWISE SPECIFIED	INITIALS	DATE
DIMENSIONS ARE IN INCHES	DRAWN GF	07/18/02
TOLERANCES ON:	CHECKED LC	08/01/02
2 PL DECIMALS \pm	APPROVED DJ	08/05/02
3 PL DECIMALS \pm .005		
ANGLES \pm		
FRACTIONS \pm		



Mini-Circuits®

13 Neptune Avenue
Brooklyn NY 11235

PL, cb, WW107, ERA, TB-408-XX+

Mini-Circuits®
THIS DOCUMENT AND ITS CONTENTS ARE THE PROPERTY OF MINI-CIRCUITS. EXCEPT FOR USE EXPRESSLY GRANTED, IN WRITING, TO ITS VENDORS, VENDEE AND THE UNITED STATES GOVERNMENT, MINI-CIRCUITS RESERVES ALL PROPRIETARY DESIGN, USE, MANUFACTURING AND REPRODUCTION RIGHTS THERETO. THESE CONTENTS SHALL NOT BE USED, DUPLICATED OR DISCLOSED TO ANY OUTSIDE PARTY, IN WHOLE OR IN PART, WITHOUT WRITTEN PERMISSION OF MINI-CIRCUITS.

SIZE	CODE IDENT	DRAWING NO:	REV:
A	15542	98-PL-075	D
FILE:	98PL075	SCALE: 8:1	SHEET: 1 OF 1

Evaluation Board and Circuit

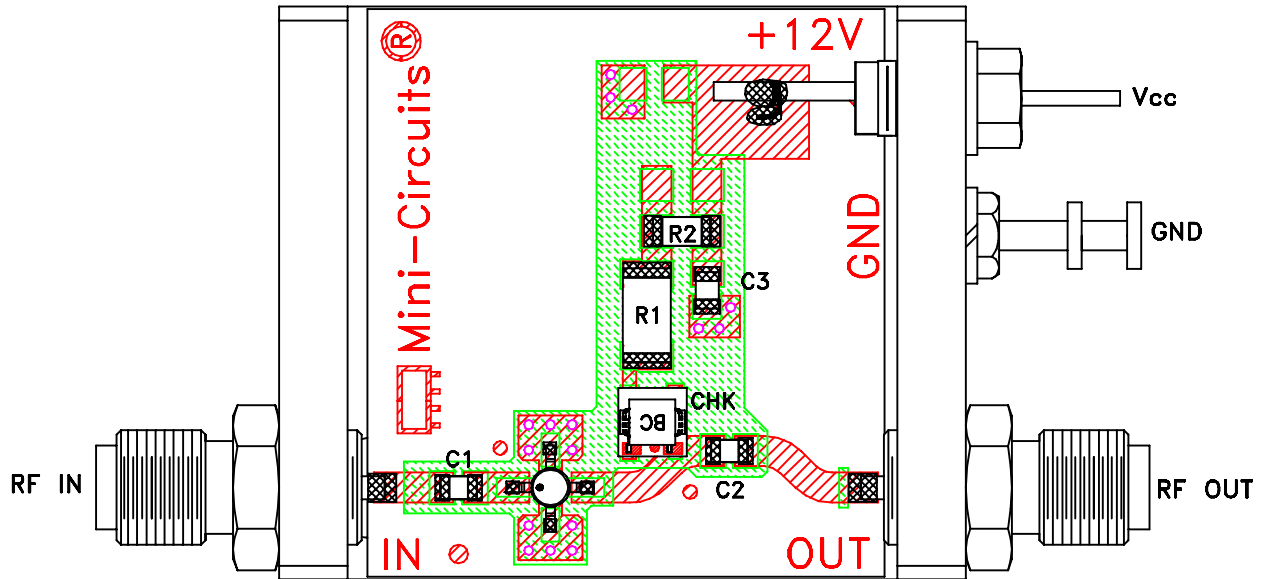

TB-408-33+

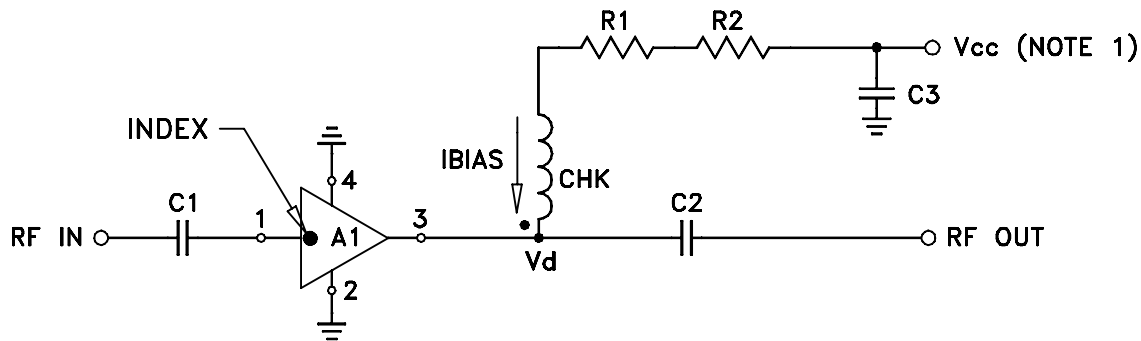

COMPONENT	VALUE
A1	ERA-33SM(+)
C1 (NOTE 4)	2400 pF
C2 (NOTE 4)	2400 pF
C3 (bypass)	0.1 uF
R1	191 Ohms, 0.75W
R2	2.21 Ohms, 0.25W
CHK	Mini-Circuits TCCH-80+

Schematic Diagram

NOTE:

1. Vcc voltage: $+12 \pm 0.2V$.
2. SMA Female connectors.
3. PCB material: Rogers R04350 or equivalent, dielectric constant=3.5, dielectric thickness=.030 inch.
4. Capacitors, C1 & C2 should be free of resonance up to the highest frequency specified.

Mini-Circuits®

All Mini-Circuits products are manufactured under exacting quality assurance and control standards, and are capable of meeting published specifications after being subjected to any or all of the following physical and environmental test.

Specification	Test/Inspection Condition	Reference/Spec
Operating Temperature	-45° to 85°C or -40° to 85°C Ambient Environment	Individual Model Data Sheet
Storage Temperature	-65° to 150° C Ambient Environment	Individual Model Data Sheet
Thermal Shock	-55° to 100°C, 100 cycles	MIL-STD-202, Method 107, Condition A-3, except +100°C
Mechanical Shock	1.5Kg, 0.5 ms, 5 shock pulses, Y1 direction only	MIL-STD-883, Method 2002, Condition B, except Y1 direction only
Vibration (Variable Frequency)	50g peak	MIL-STD-883, Method 2007, Condition B
Autoclave	15 psig, 100% RH, 121°C, 96 hours	JESD22-A102, Condition C
HAST	130°C, 85% RH, 96 hours	JESD22-A110
Solderability	10X Magnification	J-STD-002, Para 4.2.5, Test S, 95% Coverage
Solder Reflow Heat	Sn-Pb Eutetic Process: 240°C peak Pb-Free Process: 260°C peak	J-STD-020, Table 4-1, 4-2 and 5-2; Figure 5-1
Moisture Sensitivity: Level 1	Bake at 125°C for 24 hours Soak at 85°C/85% RH for 168 hours, Reflow 3 cycles at 260°C peak	J-STD-020
Marking Resistance to Solvents	Isopropyl alcohol + mineral spirits at 25°C; terpene defluxer at 25°C; distilled water + proylene glycol monomethyl ether +	MIL-STD-202, Method 215



All Mini-Circuits products are manufactured under exacting quality assurance and control standards, and are capable of meeting published specifications after being subjected to any or all of the following physical and environmental test.

Specification	Test/Inspection Condition	Reference/Spec
	monoethanolamine at 63°C to 70°C	