

Drop-In

Monolithic Amplifier

DC-4 GHz

Product Features

- DC-4 GHz
- Single voltage supply
- Internally matched to 50 ohms
- Unconditionally stable
- Low performance variation over temperature
- Transient protected
- Aqueous washable
- Protected by US Patent 6,943,629

Typical Applications

- Cellular/ PCS/ 3G Base Station
- CATV, Cable Modem & DBS
- Fixed Wireless & WLAN
- Microwave Radio & Test Equipment

General Description

ERA-5+ (RoHS compliant) is a wideband amplifier offering high dynamic range. It has repeatable performance from lot to lot. It is enclosed in an Micro-X package. ERA-5+ uses Darlington configuration and is fabricated using InGaP HBT technology. Expected MTTF is 940 years at 85°C case temperature.



Generic photo used for illustration purposes only

ERA-5+

CASE STYLE: VV105

+RoHS Compliant

The +Suffix identifies RoHS Compliance. See our web site for RoHS Compliance methodologies and qualifications

simplified schematic and pin description

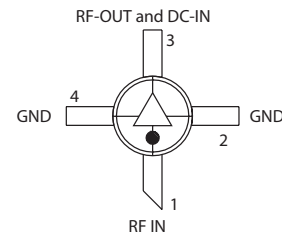

Function	Pin Number	Description
RF IN	1	RF input pin. This pin requires the use of an external DC blocking capacitor chosen for the frequency of operation.
RF-OUT and DC-IN	3	RF output and bias pin. DC voltage is present on this pin; therefore a DC blocking capacitor is necessary for proper operation. An RF choke is needed to feed DC bias without loss of RF signal due to the bias connection, as shown in "Recommended Application Circuit".
GND	2,4	Connections to ground. Use via holes as shown in "Suggested Layout for PCB Design" to reduce ground path inductance for best performance.

Notes

- A. Performance and quality attributes and conditions not expressly stated in this specification document are intended to be excluded and do not form a part of this specification document.
B. Electrical specifications and performance data contained in this specification document are based on Mini-Circuit's applicable established test performance criteria and measurement instructions.
C. The parts covered by this specification document are subject to Mini-Circuits' standard limited warranty and terms and conditions (collectively, "Standard Terms"); Purchasers of this part are entitled to the rights and benefits contained therein. For a full statement of the Standard Terms and the exclusive rights and remedies thereunder, please visit Mini-Circuits' website at www.minicircuits.com/MCLStore/terms.jsp



Electrical Specifications at 25°C and 65mA, unless noted

Parameter	Min.	Typ.	Max.	Units	Cpk	
Frequency Range*	DC		4	GHz		
Gain	f=0.1GHz f=1 GHz f=2 GHz f=3 GHz f=4 GHz	19 — 16 16 12	20.2 19.5 18.5 16.7 14.3	22 dB	≥1.5	
Magnitude of Gain Variation versus Temperature (values are negative)	f=0.1GHz f=1 GHz f=2 GHz f=3 GHz f=4 GHz		.0025 .0034 .0043 .0052 .0065	.005 .007 .0085 .0105 .013	dB/°C	
Input Return Loss	f=0.1 GHz f=2 GHz f=4 GHz		21 23 21	dB		
Output Return Loss	f=0.1 GHz f=2 GHz f=4 GHz		30 26 17	dB		
Reverse Isolation	f=2 GHz	19	22	dB		
Output Power @1 dB compression	f=0.1 GHz f=1 GHz f=2 GHz f=4 GHz	16.5 16.5 15.5	18.4 18.4 17 12.5	dBm	≥1.5	
Saturated Output Power (at 3dB compression)	f=0.1 GHz f=1 GHz f=2 GHz		19.5 18.5 18	dBm		
Output IP3	f=0.1 GHz f=1 GHz f=2 GHz f=4 GHz	30 30 26	33 33 30 26	dBm	≥1.5	
Noise Figure	f=0.1GHz f=2 GHz f=4 GHz		3.5 3.5 3.5	4.5 4.5 4.5	dB	≥1.5
Group Delay	f=2 GHz		90	psec		
Recommended Device Operating Current			65	mA		
Device Operating Voltage		4.5	4.9	5.3	V	≥1.5
Device Voltage Variation vs. Temperature at 65mA			-3.2	mV/°C		
Device Voltage Variation vs. Current at 25°C			6.9	mV/mA		
Thermal Resistance, junction-to-case ¹			128	°C/W		

*Guaranteed specification DC-4 GHz. Low frequency cut off determined by external coupling capacitors.

Absolute Maximum Ratings

Parameter	Ratings
Operating Temperature*	-45°C to 85°C
Storage Temperature	-65°C to 150°C
Operating Current	85mA
Power Dissipation	451mW
Input Power	13 dBm

Note: Permanent damage may occur if any of these limits are exceeded.

These ratings are not intended for continuous normal operation.

¹Case is defined as ground leads.

*Based on typical case temperature rise 10°C above ambient.

Notes

A. Performance and quality attributes and conditions not expressly stated in this specification document are intended to be excluded and do not form a part of this specification document.

B. Electrical specifications and performance data contained in this specification document are based on Mini-Circuit's applicable established test performance criteria and measurement instructions.

C. The parts covered by this specification document are subject to Mini-Circuits standard limited warranty and terms and conditions (collectively, "Standard Terms"); Purchasers of this part are entitled to the rights and benefits contained therein. For a full statement of the Standard Terms and the exclusive rights and remedies thereunder, please visit Mini-Circuits' website at www.minicircuits.com/MCLStore/terms.jsp



Product Marking

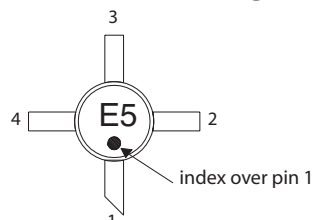

Markings in addition to model number designation may appear for internal quality control purposes.

Additional Detailed Technical Information

Additional information is available on our web site. To access this information enter the model number on our web site home page.

Performance data, graphs, s-parameter data set (.zip file)

Case Style: VV105

Plastic micro-x, .085 body diameter, lead finish: Matte-Tin

Tape & Reel: F4

7" Reels with 20, 50, 100, 200, 500, 1K devices

Suggested Layout for PCB Design: PL-261

Evaluation Board: TB-431-5+

Environmental Ratings: ENV08T2

Recommended Application Circuit

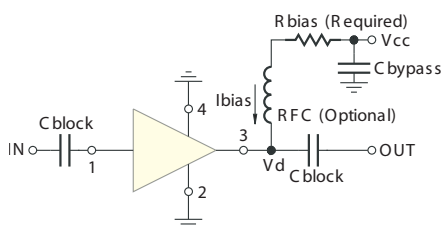

Test Board includes case, connectors, and components (in bold) soldered to PCB

R BIAS	
Vcc	"1%" Res. Values (ohms) for Optimum Biasing
7	33.2
8	48.7
9	63.4
10	78.7
11	95.3
12	110
13	124
14	140
15	158
16	174
17	187
18	205
19	221
20	232

Notes

- A. Performance and quality attributes and conditions not expressly stated in this specification document are intended to be excluded and do not form a part of this specification document.
- B. Electrical specifications and performance data contained in this specification document are based on Mini-Circuit's applicable established test performance criteria and measurement instructions.
- C. The parts covered by this specification document are subject to Mini-Circuits standard limited warranty and terms and conditions (collectively, "Standard Terms"); Purchasers of this part are entitled to the rights and benefits contained therein. For a full statement of the Standard Terms and the exclusive rights and remedies thereunder, please visit Mini-Circuits' website at www.minicircuits.com/MCLStore/terms.jsp



ESD Rating

Human Body Model (HBM): Class 1B (500 v to < 1,000 v) in accordance with ANSI/ESD STM 5.1 - 2001

Machine Model (MM): Class M1 (< 100 v) in accordance with ANSI/ESD STM 5.2 - 1999

MSL Rating

Moisture Sensitivity: MSL1 in accordance with IPC/JEDECJ-STD-020C

NO.	TEST REQUIRED	CONDITION	STANDARD	QUANTITY
1	Visual Inspection	Low Power Microscope Magnification 40x	MIP-IN-0003 (MCT spec)	45 units
2	Electrical Test	Room Temperature	SCD (MCL spec)	45 units
3	SAM Analysis	Less than 10% growth in term of delamination	J-Std-020C (Jedec Standard)	45 units
4	Moisture Sensitivity Level 1	Bake at 125°C for 24 hours Soak at 85°C/85%RH for 168 hours Reflow 3 cycles at 260°C peak	J-Std-020C (Jedec Standard)	45 units

MSL Test Flow Chart

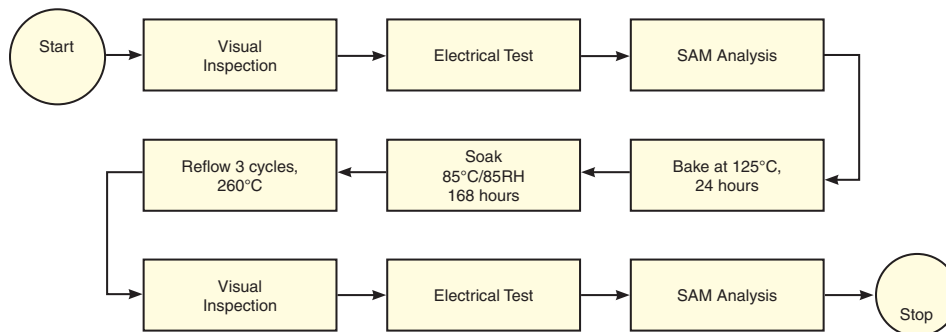

Notes

- A. Performance and quality attributes and conditions not expressly stated in this specification document are intended to be excluded and do not form a part of this specification document.
- B. Electrical specifications and performance data contained in this specification document are based on Mini-Circuit's applicable established test performance criteria and measurement instructions.
- C. The parts covered by this specification document are subject to Mini-Circuits standard limited warranty and terms and conditions (collectively, "Standard Terms"); Purchasers of this part are entitled to the rights and benefits contained therein. For a full statement of the Standard Terms and the exclusive rights and remedies thereunder, please visit Mini-Circuits' website at www.minicircuits.com/MCLStore/terms.jsp



Typical Performance Data

NOTE: Use PDF Bookmarks to view DATA at required conditions or to view GRAPHS.

Definitions:

Input Return Loss = -S11 (dB)

Gain(Power Gain) = S21 (dB)

Reverse Isolation = -S12 (dB)

Output Return Loss = -S22 (dB)

TEST CONDITIONS: Icc = 65mA, Vd = 4.77V @Temperature = +25degC

FREQ	Gain	Isolation	Input Return Loss	Output Return Loss	Stability		FREQ	IP3 Output	1dB Comp. Output	Noise Figure
(MHz)	(dB)	(dB)	(dB)	(dB)	K	Delta	(MHz)	(dBm)	(dBm)	(dB)
50	20.59	24.12	23.53	35.10	1.08	0.67	50	34.78	18.40	2.99
100	20.57	24.01	23.48	36.05	1.08	0.67	100	35.17	18.36	3.02
200	20.50	23.96	23.10	35.85	1.08	0.67	200	35.24	18.33	2.97
300	20.40	23.95	23.00	36.69	1.08	0.67	300	35.12	18.34	3.14
400	20.29	23.89	22.82	38.38	1.08	0.66	400	34.59	18.25	3.11
500	20.16	23.85	22.60	39.85	1.09	0.66	500	34.28	18.21	3.13
600	20.02	23.80	22.44	41.51	1.09	0.65	600	34.13	18.18	3.13
700	19.86	23.69	22.24	45.59	1.09	0.64	700	34.23	18.15	3.06
800	19.69	23.64	22.15	58.65	1.10	0.63	800	34.21	18.12	3.03
900	19.50	23.53	21.93	66.50	1.10	0.63	900	34.10	17.90	3.03
1000	19.31	23.43	21.76	51.14	1.11	0.62	1000	33.81	17.85	3.09
1100	19.11	23.33	21.70	43.98	1.11	0.62	1100	33.62	17.91	3.05
1200	18.90	23.21	21.54	41.24	1.12	0.61	1200	33.38	17.83	3.10
1300	18.69	23.08	21.56	38.94	1.12	0.60	1300	33.01	17.82	3.10
1400	18.48	22.96	21.55	36.76	1.13	0.60	1400	32.69	17.77	3.07
1500	18.27	22.85	21.73	34.28	1.14	0.59	1500	32.56	17.66	3.05
1600	18.05	22.69	21.61	33.61	1.14	0.58	1600	32.72	17.55	3.02
1700	17.83	22.57	21.71	32.62	1.15	0.58	1700	32.81	17.48	3.00
1800	17.62	22.42	21.87	31.37	1.15	0.57	1800	32.25	17.32	3.03
2000	17.19	22.11	21.98	29.59	1.16	0.57	1900	31.79	17.13	3.05
2100	16.96	21.98	22.05	28.85	1.16	0.56	2000	31.50	16.96	3.15
2200	16.75	21.83	21.91	28.36	1.17	0.55	2100	31.10	16.84	3.07
2400	16.31	21.52	21.87	27.41	1.17	0.55	2200	30.67	16.76	2.98
2600	15.92	21.17	21.39	26.29	1.18	0.54	2300	30.39	16.66	3.05
2800	15.47	20.90	21.01	26.05	1.19	0.53	2400	30.08	16.43	3.12
3000	15.10	20.55	20.51	24.92	1.19	0.53	2500	29.85	16.11	3.16
3200	14.72	20.23	20.13	24.19	1.19	0.52	2600	29.65	15.83	3.10
3400	14.37	19.87	19.81	23.26	1.19	0.52	2700	29.66	15.77	3.16
3600	13.96	19.65	19.98	23.34	1.20	0.51	2800	29.50	15.50	3.16
4000	13.39	18.85	19.23	21.31	1.18	0.52	2900	29.27	15.33	3.11
4500	12.57	18.20	20.40	19.59	1.19	0.51	3000	28.98	15.20	3.13
5000	11.85	17.44	20.37	16.61	1.18	0.52	3100	28.56	14.91	3.18
6000	10.55	16.18	14.66	12.10	1.14	0.54	3200	28.24	14.73	3.20
7000	9.38	15.22	10.98	9.62	1.10	0.56	3300	27.95	14.57	3.17
8000	8.29	14.35	8.32	7.76	1.04	0.59	3400	27.64	14.34	3.24
9000	6.61	13.88	6.09	6.15	1.00	0.60	3500	27.56	14.00	3.19
10000	4.03	13.64	5.00	5.17	1.03	0.55	3600	27.36	13.90	3.24
11000	1.69	13.47	4.49	4.62	1.07	0.50	3700	27.11	13.65	3.27
12000	-0.30	13.18	4.39	4.41	1.12	0.45	3800	26.90	13.45	3.35
13000	-1.90	13.10	4.24	4.34	1.14	0.39	4000	26.20	13.08	3.22

REV. X1

ERA-5+

120123

Page 1 of 11



IF/RF MICROWAVE COMPONENTS • ISO 9001 ISO 14001 AS 9100 CERTIFIED • RoHS compliant

P.O. Box 350166, Brooklyn, New York 11235-0003 (718) 934-4500 Fax (718) 332-4661



The Design Engineers Search Engine finds the model you need, Instantly • For detailed performance specs & shopping online see



Typical Performance Data

Definitions:

Input Return Loss = -S11 (dB)

Gain(Power Gain) = S21 (dB)

Reverse Isolation = -S12 (dB)

Output Return Loss = -S22 (dB)

TEST CONDITIONS: Icc = 52mA, Vd = 4.69V @Temperature = +25degC

FREQ	Gain	Isolation	Input Return Loss	Output Return Loss	Stability		FREQ	IP3 Output	1dB Comp. Output	Noise Figure
					K	Delta				
(MHz)	(dB)	(dB)	(dB)	(dB)	K	Delta	(MHz)	(dBm)	(dBm)	(dB)
50	20.40	23.82	21.72	29.33	1.08	0.68	50	31.38	16.70	2.89
100	20.39	23.89	21.60	29.44	1.08	0.67	100	31.75	16.69	2.93
200	20.31	23.84	21.40	29.40	1.08	0.67	200	31.82	16.60	2.86
300	20.22	23.77	21.42	29.94	1.08	0.67	300	31.73	16.67	3.05
400	20.12	23.75	21.37	30.67	1.09	0.66	400	31.31	16.62	3.04
500	19.99	23.70	21.27	31.25	1.09	0.65	500	31.25	16.59	3.00
600	19.86	23.63	21.20	31.99	1.09	0.65	600	31.25	16.54	3.05
700	19.70	23.55	21.10	33.30	1.10	0.64	700	31.59	16.46	2.98
800	19.53	23.49	21.11	34.88	1.10	0.64	800	31.80	16.50	2.90
900	19.35	23.39	20.99	35.82	1.11	0.63	900	31.87	16.35	2.94
1000	19.16	23.29	20.89	37.44	1.11	0.62	1000	31.80	16.35	2.99
1100	18.97	23.19	20.92	39.13	1.11	0.62	1100	31.68	16.39	2.94
1200	18.76	23.10	20.82	39.85	1.12	0.61	1200	31.57	16.38	2.97
1300	18.56	22.97	20.87	39.87	1.13	0.60	1300	31.40	16.32	3.01
1400	18.36	22.84	20.87	38.77	1.13	0.60	1400	31.19	16.29	2.96
1500	18.16	22.76	21.10	36.69	1.14	0.59	1500	31.16	16.26	2.95
1600	17.93	22.60	20.97	35.68	1.14	0.58	1600	31.41	16.22	2.89
1700	17.71	22.46	21.06	34.39	1.15	0.58	1700	31.76	16.30	2.91
1800	17.50	22.33	21.23	32.91	1.15	0.57	1800	31.29	16.25	2.94
2000	17.08	22.03	21.28	30.58	1.16	0.56	1900	30.82	16.21	2.94
2100	16.86	21.89	21.39	29.63	1.16	0.56	2000	30.64	16.14	3.05
2200	16.64	21.75	21.20	29.32	1.17	0.55	2100	30.32	16.10	2.96
2400	16.22	21.46	21.24	27.79	1.18	0.54	2200	30.01	15.96	2.90
2600	15.82	21.12	20.63	26.72	1.18	0.54	2300	29.81	15.84	2.94
2800	15.38	20.86	20.33	26.32	1.19	0.53	2400	29.59	15.66	3.01
3000	15.02	20.51	19.81	25.05	1.19	0.53	2500	29.44	15.43	3.12
3200	14.63	20.21	19.46	24.52	1.19	0.52	2600	29.18	15.22	2.98
3400	14.27	19.86	19.15	23.55	1.19	0.52	2700	29.22	15.15	3.02
3600	13.90	19.61	19.18	23.30	1.20	0.51	2800	29.07	14.92	3.03
4000	13.30	18.87	18.59	21.67	1.18	0.52	2900	28.79	14.79	2.98
4500	12.40	18.30	20.44	19.99	1.21	0.50	3000	28.52	14.59	3.06
5000	11.76	17.47	19.49	16.78	1.19	0.51	3100	28.10	14.31	3.04
6000	10.49	16.27	14.43	12.48	1.15	0.53	3200	27.83	14.16	3.06
7000	9.29	15.36	10.83	9.96	1.12	0.54	3300	27.49	13.99	3.03
8000	8.09	14.41	8.03	7.90	1.05	0.58	3400	27.31	13.84	3.12
9000	6.41	14.01	5.97	6.32	1.02	0.58	3500	27.16	13.48	3.08
10000	3.88	13.73	4.95	5.35	1.05	0.53	3600	26.93	13.36	3.11
11000	1.49	13.50	4.53	4.83	1.10	0.49	3700	26.73	13.07	3.15
12000	-0.49	13.02	4.43	4.55	1.14	0.44	3800	26.46	12.93	3.22
13000	-2.04	12.90	4.20	4.47	1.14	0.38	4000	25.77	12.48	3.07

REV. X1
ERA-5+
120123



IF/RF MICROWAVE COMPONENTS • ISO 9001 ISO 14001 AS 9100 CERTIFIED • RoHS compliant
P.O. Box 350166, Brooklyn, New York 11235-0003 (718) 934-4500 Fax (718) 332-4661



The Design Engineers Search Engine finds the model you need, Instantly • For detailed performance specs & shopping online see



Typical Performance Data

Definitions:

Input Return Loss = -S11 (dB)

Gain(Power Gain) = S21 (dB)

Reverse Isolation = -S12 (dB)

Output Return Loss = -S22 (dB)

TEST CONDITIONS: Icc = 78mA, Vd = 4.84V @Temperature = +25degC

FREQ	Gain	Isolation	Input Return Loss	Output Return Loss	Stability		FREQ	IP3 Output	1dB Comp. Output	Noise Figure
					K	Delta				
(MHz)	(dB)	(dB)	(dB)	(dB)	K	Delta	(MHz)	(dBm)	(dBm)	(dB)
50	20.72	24.09	25.12	44.79	1.07	0.68	50	37.51	19.34	3.07
100	20.70	24.19	24.95	47.10	1.08	0.67	100	37.90	19.36	3.09
200	20.62	24.09	24.50	47.52	1.08	0.67	200	37.88	19.32	3.05
300	20.53	24.07	24.29	48.87	1.08	0.67	300	37.52	19.36	3.23
400	20.42	24.02	24.03	50.48	1.08	0.66	400	36.86	19.15	3.20
500	20.28	23.95	23.66	48.50	1.09	0.66	500	36.05	19.11	3.18
600	20.13	23.88	23.39	46.37	1.09	0.65	600	35.60	19.09	3.21
700	19.97	23.79	23.05	43.10	1.09	0.64	700	35.32	19.10	3.16
800	19.80	23.73	22.91	39.49	1.10	0.64	800	34.99	18.97	3.12
900	19.61	23.63	22.59	39.17	1.10	0.63	900	34.66	18.58	3.12
1000	19.41	23.52	22.32	37.65	1.11	0.62	1000	34.30	18.51	3.17
1100	19.21	23.40	22.23	36.01	1.11	0.62	1100	34.06	18.55	3.12
1200	19.00	23.28	22.00	35.13	1.12	0.61	1200	33.73	18.50	3.18
1300	18.79	23.17	22.03	34.17	1.12	0.60	1300	33.29	18.44	3.20
1400	18.57	23.03	21.97	33.10	1.13	0.60	1400	32.97	18.33	3.16
1500	18.36	22.93	22.15	31.50	1.13	0.59	1500	32.76	18.15	3.14
1600	18.14	22.76	22.04	31.31	1.14	0.59	1600	32.83	18.02	3.12
1700	17.91	22.62	22.13	30.61	1.14	0.58	1700	32.74	17.91	3.10
1800	17.69	22.48	22.34	29.77	1.15	0.57	1800	32.22	17.69	3.11
2000	17.26	22.17	22.48	28.52	1.15	0.57	1900	31.80	17.46	3.12
2100	17.03	22.03	22.55	27.91	1.16	0.56	2000	31.55	17.28	3.20
2200	16.82	21.86	22.42	27.62	1.16	0.56	2100	31.19	17.17	3.18
2400	16.39	21.57	22.43	26.79	1.17	0.55	2200	30.72	17.11	3.09
2600	15.99	21.21	22.04	25.85	1.17	0.54	2300	30.38	17.03	3.19
2800	15.54	20.92	21.61	25.65	1.18	0.53	2400	30.13	16.82	3.25
3000	15.17	20.57	21.11	24.61	1.18	0.53	2500	29.81	16.46	3.27
3200	14.79	20.26	20.73	23.94	1.19	0.53	2600	29.67	16.19	3.17
3400	14.44	19.87	20.42	22.98	1.18	0.53	2700	29.63	16.15	3.23
3600	14.02	19.65	20.59	23.00	1.20	0.52	2800	29.47	15.87	3.26
4000	13.45	18.87	19.81	21.17	1.18	0.53	2900	29.28	15.73	3.20
4500	12.63	18.18	21.08	19.28	1.18	0.52	3000	29.03	15.63	3.24
5000	11.89	17.50	21.54	16.55	1.18	0.52	3100	28.59	15.36	3.27
6000	10.66	16.16	15.07	12.00	1.14	0.55	3200	28.34	15.13	3.29
7000	9.51	15.16	11.14	9.44	1.09	0.57	3300	28.00	14.98	3.27
8000	8.41	14.29	8.48	7.54	1.03	0.61	3400	27.76	14.78	3.33
9000	6.71	13.85	6.08	5.85	0.99	0.62	3500	27.60	14.41	3.31
10000	4.20	13.66	4.99	4.97	1.02	0.57	3600	27.44	14.28	3.35
11000	1.79	13.41	4.56	4.56	1.07	0.51	3700	27.22	14.06	3.39
12000	-0.21	12.95	4.49	4.45	1.11	0.45	3800	26.94	13.85	3.45
13000	-1.79	12.93	4.34	4.37	1.13	0.39	4000	26.27	13.49	3.37

REV. X1
ERA-5+
120123

Page 3 of 11



IF/RF MICROWAVE COMPONENTS • ISO 9001 ISO 14001 AS 9100 CERTIFIED • RoHS compliant
P.O. Box 350166, Brooklyn, New York 11235-0003 (718) 934-4500 Fax (718) 332-4661



The Design Engineers Search Engine finds the model you need, Instantly • For detailed performance specs & shopping online see



Typical Performance Data

Definitions:

Input Return Loss = -S11 (dB)

Gain(Power Gain) = S21 (dB)

Reverse Isolation = -S12 (dB)

Output Return Loss = -S22 (dB)

TEST CONDITIONS: Icc = 65mA, Vd = 5.01V @Temperature = -45degC

FREQ	Gain	Isolation	Input Return Loss	Output Return Loss	Stability		FREQ	IP3 Output	1dB Comp. Output	Noise Figure
					K	Delta				
(MHz)	(dB)	(dB)	(dB)	(dB)	K	Delta	(MHz)	(dBm)	(dBm)	(dB)
50	20.77	24.17	24.15	41.36	1.07	0.68	50	35.57	18.65	2.50
100	20.76	24.13	24.00	42.05	1.07	0.68	100	35.98	18.62	2.53
200	20.68	24.09	23.32	40.19	1.07	0.68	200	36.04	18.57	2.46
300	20.59	24.04	23.62	43.61	1.08	0.67	300	36.05	18.61	2.63
400	20.49	24.04	23.70	46.55	1.08	0.66	400	35.74	18.53	2.59
500	20.36	23.95	23.31	46.69	1.08	0.66	500	35.56	18.53	2.60
600	20.22	23.87	23.07	44.89	1.09	0.66	600	35.53	18.45	2.62
700	20.06	23.78	22.88	42.27	1.09	0.65	700	35.75	18.44	2.55
800	19.90	23.71	22.63	41.35	1.09	0.64	800	35.81	18.41	2.51
900	19.71	23.61	22.34	40.11	1.10	0.64	900	35.70	18.26	2.52
1000	19.52	23.50	22.25	38.14	1.10	0.63	1000	35.50	18.23	2.55
1100	19.33	23.40	22.18	36.64	1.11	0.62	1100	35.26	18.27	2.53
1200	19.12	23.28	21.85	36.32	1.11	0.62	1200	35.10	18.23	2.59
1300	18.92	23.15	21.88	35.50	1.11	0.61	1300	34.68	18.18	2.57
1400	18.71	23.02	21.94	34.25	1.12	0.61	1400	34.31	18.17	2.56
1500	18.51	22.89	22.12	33.06	1.12	0.60	1500	34.16	18.12	2.53
1600	18.29	22.74	21.96	32.65	1.13	0.60	1600	34.35	18.06	2.46
1700	18.07	22.60	22.20	31.67	1.13	0.59	1700	34.49	18.08	2.44
1800	17.86	22.45	22.45	30.74	1.14	0.59	1800	33.94	17.95	2.49
2000	17.44	22.15	22.41	30.21	1.14	0.58	1900	33.44	17.83	2.49
2100	17.22	22.02	22.57	29.45	1.15	0.57	2000	33.10	17.69	2.57
2200	17.02	21.86	22.85	28.63	1.15	0.57	2100	32.69	17.58	2.51
2400	16.61	21.53	23.24	27.34	1.16	0.56	2200	32.22	17.50	2.43
2600	16.20	21.19	22.61	26.99	1.16	0.56	2300	31.81	17.42	2.49
2800	15.76	20.91	22.45	26.72	1.17	0.55	2400	31.55	17.20	2.55
3000	15.40	20.56	22.08	25.67	1.17	0.55	2500	31.27	16.90	2.60
3200	15.02	20.25	21.43	25.29	1.17	0.54	2600	31.13	16.66	2.56
3400	14.69	19.86	21.29	23.83	1.17	0.55	2700	31.08	16.58	2.57
3600	14.32	19.58	21.49	23.18	1.17	0.54	2800	30.99	16.31	2.61
4000	13.71	18.90	20.76	21.92	1.16	0.54	2900	30.75	16.16	2.53
4500	12.87	18.13	22.29	18.48	1.17	0.54	3000	30.46	16.01	2.57
5000	12.23	17.49	21.62	17.32	1.16	0.54	3100	30.06	15.70	2.55
6000	11.02	16.26	16.65	13.16	1.14	0.56	3200	29.63	15.55	2.63
7000	9.93	15.19	11.83	9.91	1.09	0.60	3300	29.36	15.36	2.59
8000	8.77	14.30	8.13	7.33	1.02	0.64	3400	29.07	15.19	2.66
9000	7.36	13.76	6.29	6.15	0.96	0.63	3500	28.94	14.80	2.63
10000	5.10	13.22	5.29	5.28	0.97	0.59	3600	28.74	14.67	2.72
11000	2.49	13.28	4.44	4.36	1.00	0.55	3700	28.48	14.44	2.65
12000	0.25	12.95	4.21	4.22	1.04	0.49	3800	28.28	14.27	2.72
13000	-1.10	12.47	4.18	4.35	0.99	0.40	4000	27.58	13.94	2.63

REV. X1
ERA-5+
120123

Page 4 of 11



IF/RF MICROWAVE COMPONENTS • ISO 9001 ISO 14001 AS 9100 CERTIFIED • RoHS compliant
P.O. Box 350166, Brooklyn, New York 11235-0003 (718) 934-4500 Fax (718) 332-4661



The Design Engineers Search Engine finds the model you need, Instantly • For detailed performance specs & shopping online see



Typical Performance Data

Definitions:

Input Return Loss = -S11 (dB)

Gain(Power Gain) = S21 (dB)

Reverse Isolation = -S12 (dB)

Output Return Loss = -S22 (dB)

TEST CONDITIONS: Icc = 52mA, Vd = 4.93V @Temperature = -45degC

FREQ	Gain	Isolation	Input Return Loss	Output Return Loss	Stability		FREQ	IP3 Output	1dB Comp. Output	Noise Figure
					K	Delta				
(MHz)	(dB)	(dB)	(dB)	(dB)	K	Delta	(MHz)	(dBm)	(dBm)	(dB)
50	20.62	23.98	22.54	32.90	1.07	0.68	50	31.99	16.82	2.38
100	20.60	23.95	22.36	33.02	1.07	0.68	100	32.30	16.67	2.45
200	20.53	24.00	21.88	32.04	1.08	0.67	200	32.30	16.62	2.40
300	20.44	23.94	22.20	33.86	1.08	0.67	300	32.36	16.69	2.55
400	20.34	23.90	22.33	36.24	1.08	0.66	400	32.09	16.71	2.56
500	20.22	23.83	22.11	36.71	1.08	0.66	500	32.13	16.68	2.53
600	20.08	23.75	22.01	37.47	1.09	0.66	600	32.18	16.58	2.57
700	19.93	23.68	21.92	39.64	1.09	0.65	700	32.61	16.53	2.51
800	19.77	23.60	21.76	42.52	1.09	0.64	800	32.89	16.57	2.42
900	19.59	23.50	21.59	43.67	1.10	0.64	900	32.98	16.42	2.42
1000	19.39	23.40	21.58	47.60	1.10	0.63	1000	32.94	16.48	2.49
1100	19.21	23.28	21.56	52.10	1.11	0.63	1100	32.82	16.53	2.43
1200	19.01	23.16	21.31	50.85	1.11	0.62	1200	32.82	16.47	2.50
1300	18.81	23.04	21.38	46.06	1.11	0.61	1300	32.67	16.41	2.52
1400	18.61	22.92	21.46	41.56	1.12	0.61	1400	32.52	16.34	2.47
1500	18.41	22.79	21.64	38.11	1.12	0.60	1500	32.47	16.36	2.45
1600	18.19	22.66	21.55	37.18	1.13	0.60	1600	32.75	16.33	2.41
1700	17.97	22.53	21.76	35.22	1.13	0.59	1700	33.11	16.50	2.39
1800	17.77	22.38	22.00	33.50	1.14	0.59	1800	32.69	16.48	2.40
2000	17.35	22.08	21.96	32.11	1.14	0.58	1900	32.28	16.48	2.46
2100	17.13	21.95	22.12	31.21	1.15	0.57	2000	32.06	16.51	2.49
2200	16.93	21.80	22.34	30.04	1.15	0.57	2100	31.75	16.55	2.45
2400	16.52	21.48	22.62	28.33	1.16	0.56	2200	31.40	16.40	2.37
2600	16.12	21.15	21.97	27.71	1.16	0.56	2300	31.22	16.26	2.41
2800	15.69	20.89	21.81	27.36	1.17	0.55	2400	30.96	16.14	2.49
3000	15.33	20.54	21.38	26.12	1.17	0.54	2500	30.72	16.05	2.54
3200	14.95	20.21	20.80	25.69	1.17	0.54	2600	30.53	15.89	2.49
3400	14.62	19.83	20.62	24.09	1.17	0.54	2700	30.57	15.87	2.49
3600	14.25	19.55	20.83	23.47	1.17	0.54	2800	30.38	15.63	2.52
4000	13.63	18.89	20.10	22.19	1.17	0.54	2900	30.19	15.47	2.48
4500	12.79	18.14	21.39	18.74	1.17	0.53	3000	29.95	15.35	2.51
5000	12.15	17.52	20.71	17.56	1.17	0.53	3100	29.53	15.08	2.49
6000	10.93	16.31	16.13	13.38	1.14	0.55	3200	29.16	14.95	2.53
7000	9.83	15.25	11.53	10.11	1.10	0.58	3300	28.89	14.78	2.52
8000	8.65	14.37	7.96	7.54	1.02	0.63	3400	28.54	14.59	2.56
9000	7.22	13.84	6.18	6.34	0.97	0.62	3500	28.42	14.22	2.55
10000	4.96	13.29	5.22	5.45	0.98	0.58	3600	28.22	14.09	2.62
11000	2.35	13.34	4.39	4.49	1.02	0.54	3700	28.03	13.88	2.57
12000	0.11	13.01	4.17	4.32	1.05	0.48	3800	27.79	13.69	2.62
13000	-1.26	12.52	4.13	4.40	0.99	0.40	4000	27.09	13.33	2.56

REV. X1
ERA-5+
120123



IF/RF MICROWAVE COMPONENTS • ISO 9001 ISO 14001 AS 9100 CERTIFIED • RoHS compliant
P.O. Box 350166, Brooklyn, New York 11235-0003 (718) 934-4500 Fax (718) 332-4661



The Design Engineers Search Engine finds the model you need, Instantly • For detailed performance specs & shopping online see



Typical Performance Data

Definitions:

Input Return Loss = -S11 (dB)

Gain(Power Gain) = S21 (dB)

Reverse Isolation = -S12 (dB)

Output Return Loss = -S22 (dB)

TEST CONDITIONS: Icc = 78mA, Vd = 5.08V @Temperature = -45degC

FREQ	Gain	Isolation	Input Return Loss	Output Return Loss	Stability		FREQ	IP3 Output	1dB Comp. Output	Noise Figure
					K	Delta				
(MHz)	(dB)	(dB)	(dB)	(dB)	K	Delta	(MHz)	(dBm)	(dBm)	(dB)
50	20.88	24.22	25.68	45.24	1.07	0.68	50	38.35	19.76	2.54
100	20.86	24.27	25.39	47.02	1.08	0.68	100	38.92	19.77	2.59
200	20.79	24.20	24.53	48.64	1.08	0.68	200	38.87	19.72	2.54
300	20.70	24.15	24.83	41.77	1.08	0.67	300	38.78	19.77	2.68
400	20.59	24.11	24.79	38.41	1.08	0.67	400	38.34	19.60	2.69
500	20.46	24.06	24.25	38.38	1.08	0.66	500	37.74	19.56	2.65
600	20.32	23.97	23.87	37.56	1.09	0.66	600	37.37	19.56	2.67
700	20.16	23.88	23.58	35.72	1.09	0.65	700	37.18	19.55	2.63
800	19.99	23.80	23.22	35.00	1.09	0.64	800	36.84	19.49	2.55
900	19.80	23.69	22.84	34.55	1.10	0.64	900	36.55	19.21	2.57
1000	19.61	23.59	22.67	33.36	1.10	0.63	1000	36.15	19.15	2.63
1100	19.41	23.46	22.57	32.53	1.10	0.63	1100	35.89	19.19	2.57
1200	19.20	23.35	22.20	32.38	1.11	0.62	1200	35.54	19.14	2.65
1300	19.00	23.22	22.18	32.01	1.11	0.61	1300	35.10	19.14	2.64
1400	18.79	23.09	22.22	31.24	1.12	0.61	1400	34.73	19.04	2.60
1500	18.59	22.94	22.38	30.47	1.12	0.60	1500	34.51	18.88	2.60
1600	18.37	22.80	22.21	30.34	1.13	0.60	1600	34.63	18.78	2.56
1700	18.14	22.67	22.42	29.63	1.13	0.59	1700	34.52	18.67	2.54
1800	17.93	22.49	22.72	29.04	1.13	0.59	1800	34.06	18.46	2.57
2000	17.51	22.18	22.71	28.83	1.14	0.58	1900	33.60	18.27	2.60
2100	17.28	22.05	22.85	28.24	1.15	0.57	2000	33.29	18.06	2.65
2200	17.08	21.90	23.19	27.58	1.15	0.57	2100	32.86	17.98	2.61
2400	16.67	21.56	23.67	26.55	1.15	0.57	2200	32.39	17.92	2.53
2600	16.26	21.21	23.10	26.38	1.16	0.56	2300	31.94	17.86	2.59
2800	15.83	20.94	22.94	26.18	1.17	0.55	2400	31.63	17.64	2.64
3000	15.47	20.58	22.59	25.23	1.17	0.55	2500	31.35	17.32	2.70
3200	15.09	20.27	21.97	24.96	1.17	0.55	2600	31.18	17.06	2.61
3400	14.76	19.87	21.84	23.54	1.16	0.55	2700	31.20	17.00	2.65
3600	14.39	19.58	22.09	22.90	1.17	0.54	2800	31.05	16.73	2.68
4000	13.78	18.89	21.30	21.71	1.16	0.55	2900	30.90	16.60	2.64
4500	12.93	18.11	23.17	18.27	1.16	0.55	3000	30.63	16.47	2.66
5000	12.29	17.47	22.58	17.13	1.16	0.55	3100	30.24	16.22	2.63
6000	11.09	16.24	17.18	13.00	1.13	0.56	3200	29.83	16.05	2.70
7000	10.02	15.14	12.14	9.75	1.08	0.60	3300	29.54	15.83	2.67
8000	8.88	14.23	8.31	7.16	1.01	0.66	3400	29.22	15.64	2.74
9000	7.51	13.70	6.42	5.96	0.96	0.65	3500	29.19	15.30	2.69
10000	5.26	13.16	5.37	5.12	0.96	0.61	3600	28.97	15.21	2.83
11000	2.64	13.23	4.50	4.25	0.99	0.56	3700	28.79	14.89	2.76
12000	0.40	12.92	4.26	4.15	1.03	0.50	3800	28.59	14.74	2.80
13000	-0.94	12.42	4.23	4.30	0.97	0.41	4000	27.88	14.43	2.75

REV. X1
ERA-5+
120123
Page 6 of 11



IF/RF MICROWAVE COMPONENTS • ISO 9001 ISO 14001 AS 9100 CERTIFIED • RoHS compliant
P.O. Box 350166, Brooklyn, New York 11235-0003 (718) 934-4500 Fax (718) 332-4661



The Design Engineers Search Engine finds the model you need, Instantly • For detailed performance specs & shopping online see



Typical Performance Data

Definitions:

Input Return Loss = -S11 (dB)

Gain(Power Gain) = S21 (dB)

Reverse Isolation = -S12 (dB)

Output Return Loss = -S22 (dB)

TEST CONDITIONS: Icc = 65mA, Vd = 4.61V @Temperature = +85degC

FREQ	Gain	Isolation	Input Return Loss	Output Return Loss	Stability		FREQ	IP3 Output	1dB Comp. Output	Noise Figure
					K	Delta				
(MHz)	(dB)	(dB)	(dB)	(dB)	K	Delta	(MHz)	(dBm)	(dBm)	(dB)
50	20.47	24.00	22.77	32.26	1.08	0.67	50	34.16	18.14	3.37
100	20.45	23.93	22.96	33.23	1.08	0.67	100	34.62	18.12	3.43
200	20.37	23.92	22.83	33.46	1.08	0.67	200	34.69	18.09	3.33
300	20.28	23.87	22.63	33.94	1.08	0.66	300	34.49	18.11	3.54
400	20.17	23.86	22.31	34.48	1.09	0.66	400	33.87	17.95	3.50
500	20.03	23.74	22.10	35.14	1.09	0.65	500	33.49	17.91	3.51
600	19.89	23.72	21.95	36.13	1.10	0.64	600	33.28	17.90	3.54
700	19.72	23.64	21.76	37.89	1.10	0.64	700	33.28	17.86	3.49
800	19.55	23.58	21.61	39.67	1.10	0.63	800	33.20	17.78	3.45
900	19.36	23.47	21.39	40.64	1.11	0.62	900	33.05	17.52	3.41
1000	19.16	23.39	21.23	41.76	1.12	0.62	1000	32.76	17.44	3.52
1100	18.96	23.27	21.17	41.31	1.12	0.61	1100	32.55	17.50	3.46
1200	18.74	23.16	20.99	39.98	1.13	0.60	1200	32.31	17.44	3.48
1300	18.53	23.05	20.98	38.27	1.13	0.59	1300	31.94	17.38	3.52
1400	18.32	22.92	20.95	36.54	1.14	0.59	1400	31.64	17.31	3.49
1500	18.11	22.82	21.14	34.55	1.14	0.58	1500	31.49	17.12	3.45
1600	17.88	22.66	20.99	33.43	1.15	0.58	1600	31.64	17.02	3.43
1700	17.65	22.52	21.09	32.30	1.15	0.57	1700	31.64	16.94	3.44
1800	17.43	22.40	21.23	31.11	1.16	0.56	1800	31.06	16.71	3.45
2000	17.00	22.08	21.33	29.01	1.17	0.56	1900	30.59	16.52	3.47
2100	16.77	21.97	21.40	28.32	1.17	0.55	2000	30.28	16.30	3.53
2200	16.55	21.80	21.22	27.87	1.18	0.54	2100	29.88	16.18	3.50
2400	16.11	21.50	21.18	26.68	1.19	0.53	2200	29.48	16.07	3.43
2600	15.71	21.16	20.77	25.43	1.19	0.53	2300	29.16	15.99	3.49
2800	15.26	20.89	20.43	24.99	1.20	0.52	2400	28.90	15.73	3.55
3000	14.88	20.53	19.89	23.89	1.20	0.52	2500	28.63	15.38	3.59
3200	14.49	20.23	19.56	23.28	1.20	0.51	2600	28.46	15.12	3.52
3400	14.13	19.87	19.28	22.30	1.20	0.51	2700	28.40	15.04	3.58
3600	13.74	19.59	19.29	22.05	1.21	0.50	2800	28.19	14.78	3.58
4000	13.11	18.89	18.68	20.75	1.20	0.50	2900	27.99	14.61	3.53
4500	12.24	18.21	19.90	19.00	1.21	0.49	3000	27.70	14.45	3.59
5000	11.54	17.43	19.19	16.24	1.20	0.50	3100	27.27	14.17	3.58
6000	10.20	16.23	14.17	11.99	1.17	0.52	3200	26.99	14.01	3.64
7000	8.95	15.30	10.42	9.47	1.12	0.53	3300	26.66	13.84	3.59
8000	7.69	14.43	7.88	7.69	1.06	0.56	3400	26.40	13.62	3.69
9000	5.91	14.04	6.01	6.31	1.05	0.55	3500	26.27	13.22	3.64
10000	3.33	13.78	5.00	5.29	1.10	0.52	3600	26.12	13.13	3.70
11000	0.88	13.61	4.58	4.70	1.16	0.47	3700	25.84	12.88	3.72
12000	-1.09	13.05	4.53	4.63	1.22	0.42	3800	25.56	12.69	3.79
13000	-2.40	12.69	4.41	4.62	1.21	0.36	4000	24.87	12.36	3.70

REV. X1
ERA-5+
120123

Page 7 of 11



IF/RF MICROWAVE COMPONENTS • ISO 9001 ISO 14001 AS 9100 CERTIFIED • RoHS compliant

P.O. Box 350166, Brooklyn, New York 11235-0003 (718) 934-4500 Fax (718) 332-4661



The Design Engineers Search Engine finds the model you need, Instantly • For detailed performance specs & shopping online see



Typical Performance Data

Definitions:

Input Return Loss = -S11 (dB)

Gain(Power Gain) = S21 (dB)

Reverse Isolation = -S12 (dB)

Output Return Loss = -S22 (dB)

TEST CONDITIONS: Icc = 52mA, Vd = 4.54V @Temperature = +85degC

FREQ	Gain	Isolation	Input Return Loss	Output Return Loss	Stability		FREQ	IP3 Output	1dB Comp. Output	Noise Figure
					K	Delta				
(MHz)	(dB)	(dB)	(dB)	(dB)	K	Delta	(MHz)	(dBm)	(dBm)	(dB)
50	20.27	23.73	21.10	27.11	1.08	0.67	50	30.98	16.58	3.32
100	20.25	23.75	21.17	27.62	1.08	0.67	100	31.35	16.54	3.37
200	20.18	23.73	21.05	27.89	1.08	0.67	200	31.51	16.50	3.28
300	20.09	23.71	21.02	28.19	1.08	0.66	300	31.35	16.53	3.45
400	19.98	23.69	20.85	28.53	1.09	0.66	400	30.84	16.45	3.46
500	19.85	23.63	20.75	28.90	1.09	0.65	500	30.72	16.46	3.44
600	19.71	23.57	20.68	29.40	1.10	0.64	600	30.71	16.38	3.47
700	19.55	23.49	20.57	30.38	1.10	0.64	700	30.97	16.35	3.41
800	19.38	23.42	20.55	31.27	1.10	0.63	800	31.10	16.35	3.37
900	19.19	23.33	20.41	31.81	1.11	0.62	900	31.15	16.19	3.39
1000	19.00	23.24	20.31	32.60	1.12	0.62	1000	31.01	16.17	3.44
1100	18.81	23.13	20.31	33.55	1.12	0.61	1100	30.90	16.20	3.39
1200	18.60	23.02	20.20	34.01	1.13	0.60	1200	30.77	16.19	3.42
1300	18.39	22.93	20.23	34.07	1.13	0.59	1300	30.60	16.14	3.45
1400	18.18	22.81	20.22	33.92	1.14	0.59	1400	30.36	16.12	3.42
1500	17.97	22.70	20.40	33.74	1.14	0.58	1500	30.34	16.04	3.39
1600	17.76	22.56	20.29	32.78	1.15	0.58	1600	30.56	15.95	3.33
1700	17.53	22.41	20.38	32.08	1.15	0.57	1700	30.87	16.02	3.34
1800	17.32	22.29	20.49	31.19	1.16	0.56	1800	30.35	15.90	3.36
2000	16.89	22.00	20.57	29.22	1.17	0.55	1900	29.87	15.80	3.39
2100	16.66	21.87	20.64	28.66	1.17	0.55	2000	29.63	15.68	3.48
2200	16.44	21.73	20.46	28.16	1.18	0.54	2100	29.30	15.61	3.42
2400	16.01	21.42	20.38	26.95	1.19	0.53	2200	28.97	15.45	3.35
2600	15.61	21.11	19.98	25.59	1.19	0.53	2300	28.76	15.34	3.39
2800	15.17	20.83	19.69	25.16	1.20	0.52	2400	28.53	15.10	3.46
3000	14.79	20.49	19.17	24.02	1.20	0.51	2500	28.28	14.80	3.49
3200	14.40	20.20	18.88	23.44	1.21	0.51	2600	28.17	14.59	3.45
3400	14.03	19.84	18.61	22.45	1.20	0.50	2700	28.05	14.49	3.49
3600	13.65	19.58	18.60	22.26	1.21	0.50	2800	27.89	14.23	3.53
4000	13.03	18.88	18.07	20.98	1.20	0.50	2900	27.59	14.07	3.46
4500	12.15	18.21	19.18	19.30	1.22	0.49	3000	27.36	13.90	3.51
5000	11.46	17.45	18.55	16.52	1.20	0.50	3100	26.94	13.64	3.50
6000	10.11	16.29	13.87	12.25	1.18	0.51	3200	26.63	13.43	3.51
7000	8.84	15.38	10.24	9.72	1.14	0.52	3300	26.42	13.31	3.52
8000	7.57	14.53	7.77	7.93	1.08	0.54	3400	26.14	13.10	3.62
9000	5.79	14.12	5.95	6.53	1.06	0.54	3500	26.01	12.74	3.52
10000	3.21	13.86	4.96	5.45	1.11	0.51	3600	25.85	12.67	3.58
11000	0.75	13.69	4.54	4.80	1.18	0.46	3700	25.57	12.35	3.64
12000	-1.22	13.13	4.48	4.69	1.23	0.41	3800	25.26	12.18	3.65
13000	-2.56	12.75	4.37	4.65	1.22	0.36	4000	24.59	11.86	3.56

REV. X1
ERA-5+
120123

Page 8 of 11



IF/RF MICROWAVE COMPONENTS • ISO 9001 ISO 14001 AS 9100 CERTIFIED • RoHS compliant

P.O. Box 350166, Brooklyn, New York 11235-0003 (718) 934-4500 Fax (718) 332-4661



The Design Engineers Search Engine finds the model you need, Instantly • For detailed performance specs & shopping online see



Typical Performance Data

Definitions:

Input Return Loss = -S11 (dB)

Gain(Power Gain) = S21 (dB)

Reverse Isolation = -S12 (dB)

Output Return Loss = -S22 (dB)

TEST CONDITIONS: Icc = 78mA, Vd = 4.68V @Temperature = +85degC

FREQ	Gain	Isolation	Input Return Loss	Output Return Loss	Stability		FREQ	IP3 Output	1dB Comp. Output	Noise Figure
					K	Delta				
(MHz)	(dB)	(dB)	(dB)	(dB)	K	Delta	(MHz)	(dBm)	(dBm)	(dB)
50	20.61	24.13	24.52	38.71	1.08	0.67	50	36.92	18.94	3.46
100	20.58	24.09	24.52	40.99	1.08	0.67	100	37.47	18.98	3.48
200	20.51	24.02	24.22	42.28	1.08	0.67	200	37.31	18.95	3.42
300	20.41	24.01	23.98	43.42	1.08	0.66	300	36.72	19.00	3.61
400	20.29	23.95	23.56	45.69	1.09	0.66	400	36.02	18.76	3.59
500	20.16	23.89	23.18	47.24	1.09	0.65	500	35.19	18.67	3.59
600	20.01	23.82	22.93	51.38	1.09	0.65	600	34.66	18.65	3.60
700	19.84	23.74	22.60	63.49	1.10	0.64	700	34.31	18.66	3.58
800	19.67	23.67	22.39	48.67	1.10	0.63	800	33.90	18.51	3.51
900	19.47	23.57	22.10	46.82	1.11	0.62	900	33.60	18.08	3.55
1000	19.27	23.47	21.85	43.28	1.11	0.62	1000	33.17	17.96	3.57
1100	19.06	23.35	21.77	39.58	1.12	0.61	1100	32.94	17.99	3.53
1200	18.84	23.26	21.52	38.01	1.13	0.60	1200	32.62	17.93	3.57
1300	18.63	23.13	21.50	36.37	1.13	0.60	1300	32.17	17.87	3.62
1400	18.41	23.00	21.47	34.85	1.14	0.59	1400	31.88	17.72	3.55
1500	18.19	22.91	21.62	32.88	1.14	0.58	1500	31.68	17.53	3.54
1600	17.97	22.73	21.49	32.25	1.15	0.58	1600	31.78	17.39	3.52
1700	17.73	22.60	21.57	31.25	1.15	0.57	1700	31.51	17.28	3.52
1800	17.51	22.46	21.74	30.23	1.16	0.56	1800	30.96	17.04	3.51
2000	17.07	22.14	21.89	28.49	1.17	0.56	1900	30.57	16.83	3.54
2100	16.84	22.01	21.95	27.84	1.17	0.55	2000	30.24	16.62	3.64
2200	16.62	21.87	21.79	27.47	1.18	0.54	2100	29.87	16.48	3.62
2400	16.18	21.54	21.77	26.38	1.18	0.54	2200	29.42	16.41	3.52
2600	15.77	21.20	21.38	25.24	1.19	0.53	2300	29.11	16.33	3.57
2800	15.32	20.91	21.01	24.84	1.20	0.52	2400	28.82	16.10	3.67
3000	14.94	20.56	20.43	23.78	1.20	0.52	2500	28.55	15.74	3.68
3200	14.54	20.25	20.09	23.20	1.20	0.51	2600	28.34	15.46	3.58
3400	14.18	19.87	19.79	22.20	1.20	0.51	2700	28.35	15.39	3.69
3600	13.79	19.60	19.76	21.95	1.21	0.50	2800	28.16	15.10	3.71
4000	13.17	18.89	19.13	20.64	1.19	0.51	2900	27.92	14.95	3.66
4500	12.30	18.21	20.44	18.82	1.21	0.50	3000	27.66	14.82	3.69
5000	11.60	17.40	19.68	16.07	1.19	0.51	3100	27.23	14.54	3.72
6000	10.26	16.20	14.35	11.84	1.16	0.52	3200	26.95	14.36	3.75
7000	9.01	15.24	10.53	9.33	1.11	0.54	3300	26.62	14.20	3.71
8000	7.76	14.37	7.95	7.55	1.06	0.57	3400	26.35	13.99	3.82
9000	5.99	13.97	6.05	6.17	1.04	0.56	3500	26.21	13.63	3.79
10000	3.40	13.73	5.03	5.18	1.09	0.53	3600	26.02	13.45	3.81
11000	0.95	13.58	4.60	4.61	1.15	0.48	3700	25.76	13.30	3.85
12000	-1.00	13.03	4.56	4.57	1.21	0.42	3800	25.45	13.05	3.89
13000	-2.32	12.67	4.44	4.60	1.20	0.37	4000	24.80	12.68	3.83

REV. X1
ERA-5+
120123
Page 9 of 11



IF/RF MICROWAVE COMPONENTS • ISO 9001 ISO 14001 AS 9100 CERTIFIED • RoHS compliant
P.O. Box 350166, Brooklyn, New York 11235-0003 (718) 934-4500 Fax (718) 332-4661



The Design Engineers Search Engine finds the model you need, Instantly • For detailed performance specs & shopping online see



Typical Performance Curves

GAIN vs. TEMPERATURE

INPUT POWER = -20dBm, CURRENT = 65mA

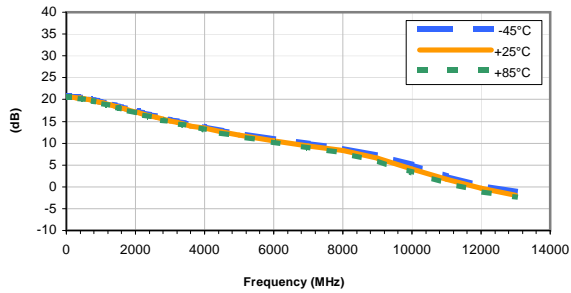

GAIN vs. CURRENT

INPUT POWER = -20dBm, Temperature = +25°C

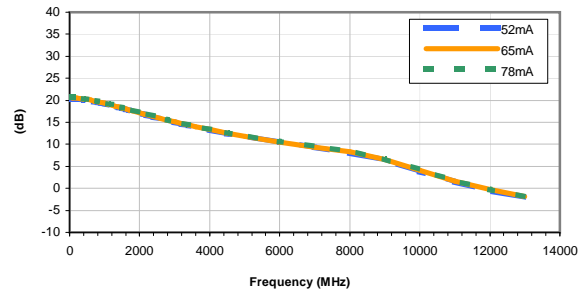

ISOLATION vs. TEMPERATURE

INPUT POWER = -20dBm, CURRENT = 65mA

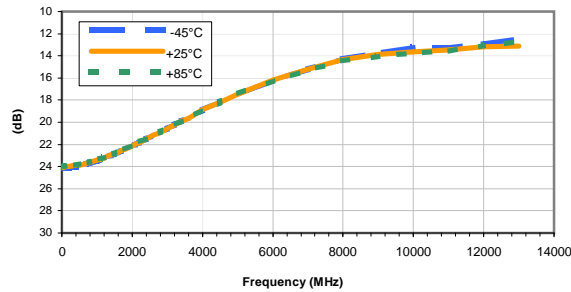

ISOLATION vs. CURRENT

INPUT POWER = -20dBm, Temperature = +25°C

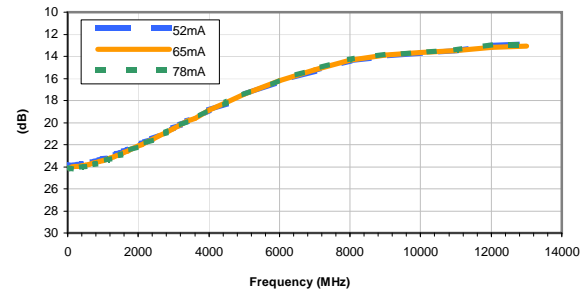

INPUT RETURN LOSS vs. TEMPERATURE

INPUT POWER = -20dBm, CURRENT = 65mA

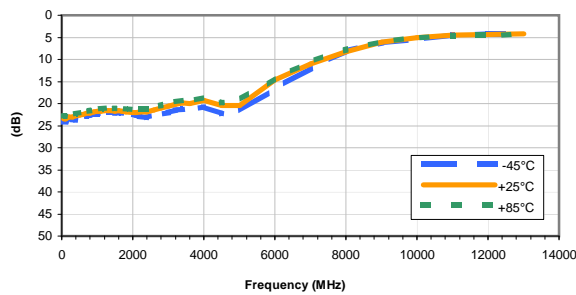

INPUT RETURN LOSS vs. CURRENT

INPUT POWER = -20dBm, Temperature = +25°C

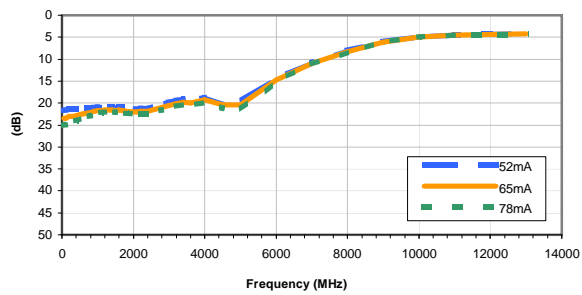

OUTPUT RETURN LOSS vs. TEMPERATURE

INPUT POWER = -20dBm, CURRENT = 65mA

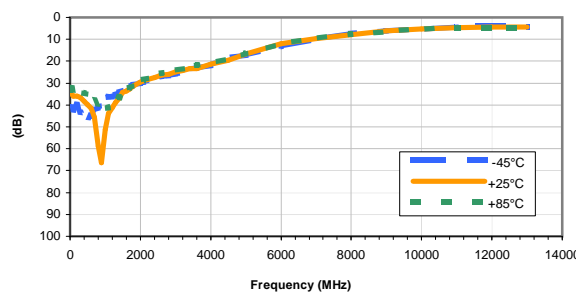

OUTPUT RETURN LOSS vs. CURRENT

INPUT POWER = -20dBm, Temperature = +25°C

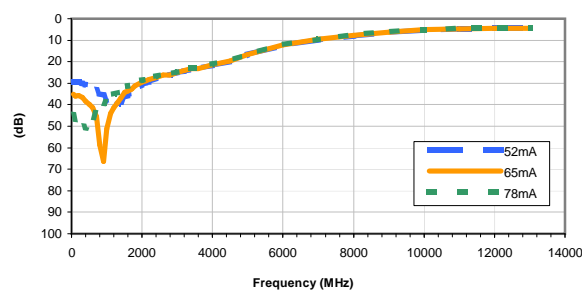

IF/RF MICROWAVE COMPONENTS • ISO 9001 ISO 14001 AS 9100 CERTIFIED • RoHS compliant
P.O. Box 350166, Brooklyn, New York 11235-0003 (718) 934-4500 Fax (718) 332-4661



The Design Engineers Search Engine finds the model you need, Instantly • For detailed performance specs & shopping online see



Typical Performance Curves

OUTPUT IP3 vs. TEMPERATURE

INPUT POWER = -20dBm, CURRENT = 65mA

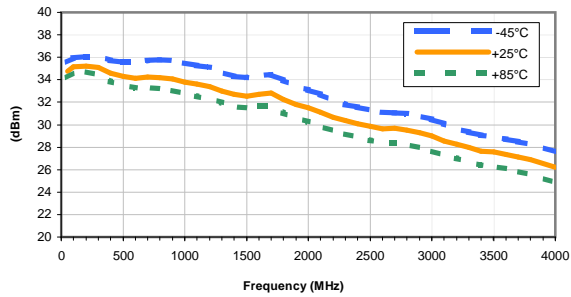

OUTPUT IP3 vs. CURRENT

INPUT POWER = -20dBm, Temperature = +25°C

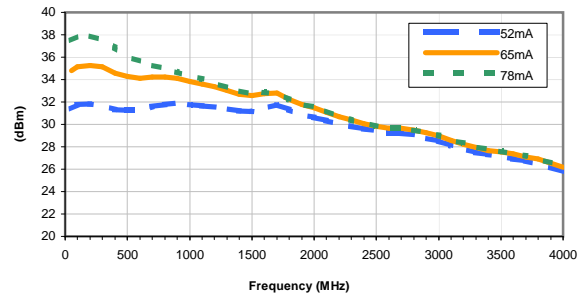

OUTPUT POWER at 1dB Compression vs. TEMPERATURE

CURRENT = 65mA

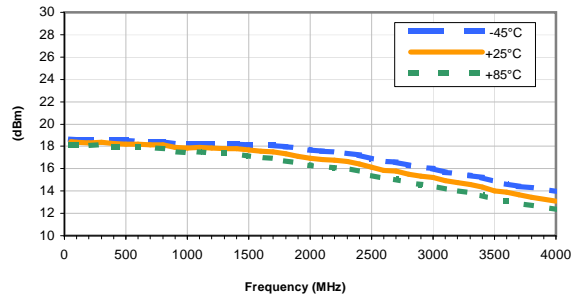

OUTPUT POWER at 1dB Compression vs. CURRENT

Temperature = +25°C

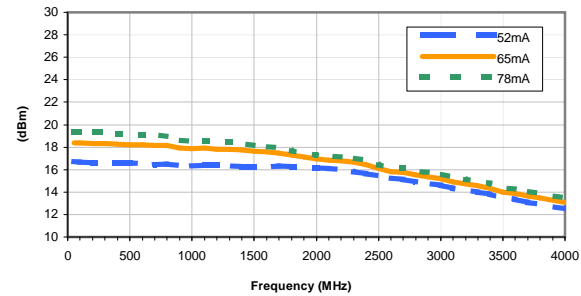

Noise Figure vs. TEMPERATURE

CURRENT = 65mA

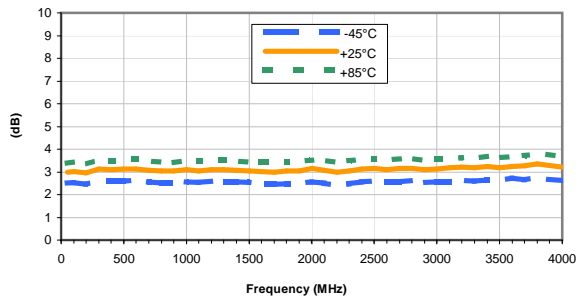

Noise Figure vs. CURRENT

Temperature = +25°C

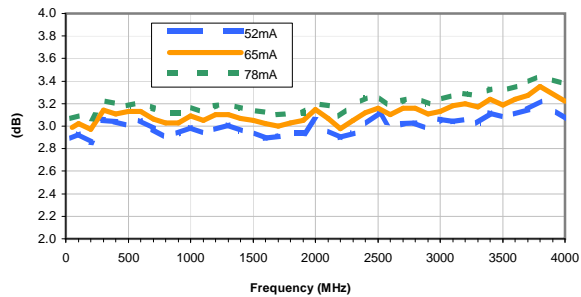

Typical Performance Curves

GAIN vs. TEMPERATURE

INPUT POWER = -20dBm, CURRENT = 65mA

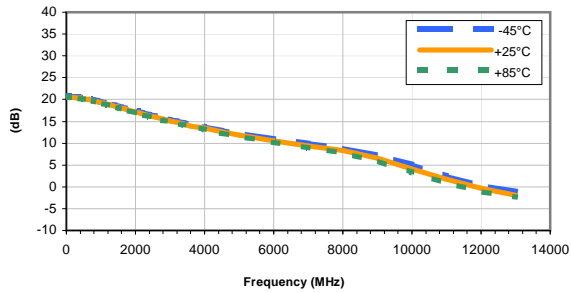

GAIN vs. CURRENT

INPUT POWER = -20dBm, Temperature = +25°C

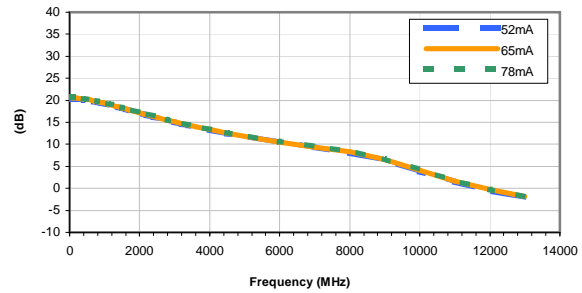

ISOLATION vs. TEMPERATURE

INPUT POWER = -20dBm, CURRENT = 65mA

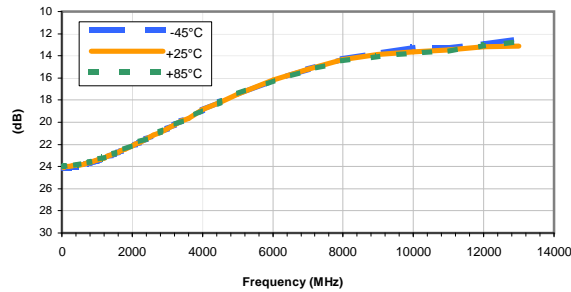

ISOLATION vs. CURRENT

INPUT POWER = -20dBm, Temperature = +25°C

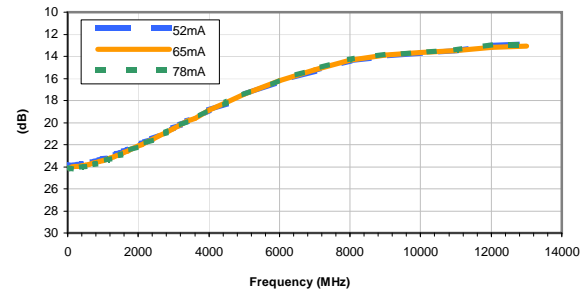

INPUT RETURN LOSS vs. TEMPERATURE

INPUT POWER = -20dBm, CURRENT = 65mA

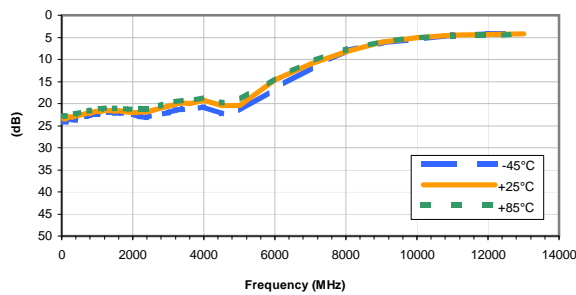

INPUT RETURN LOSS vs. CURRENT

INPUT POWER = -20dBm, Temperature = +25°C

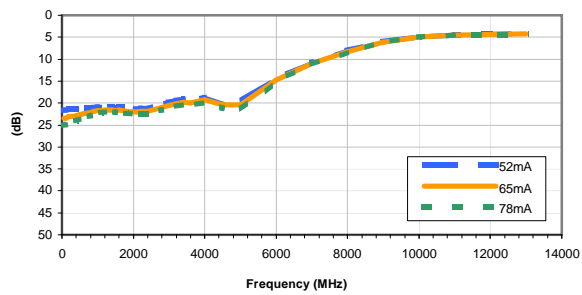

OUTPUT RETURN LOSS vs. TEMPERATURE

INPUT POWER = -20dBm, CURRENT = 65mA

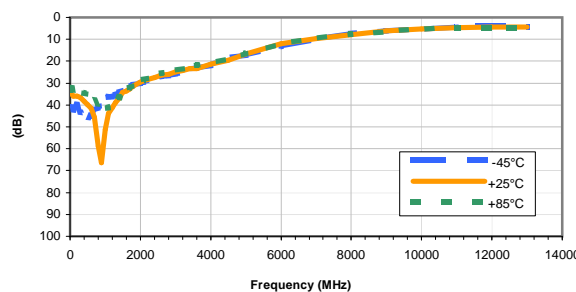

OUTPUT RETURN LOSS vs. CURRENT

INPUT POWER = -20dBm, Temperature = +25°C

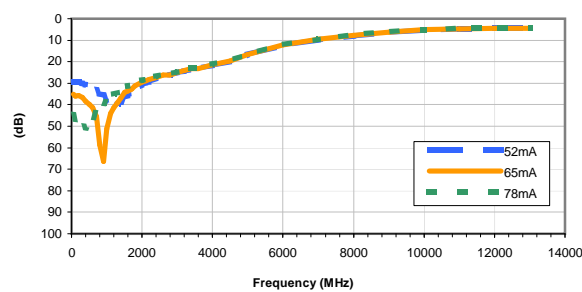

Typical Performance Curves

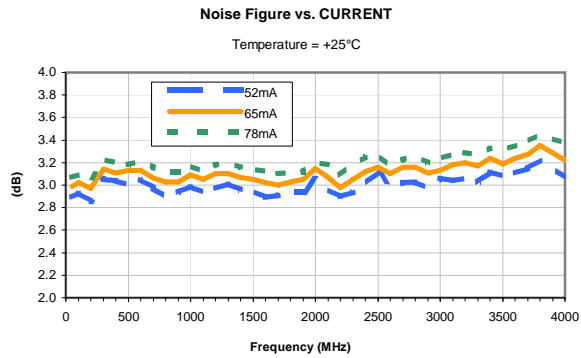
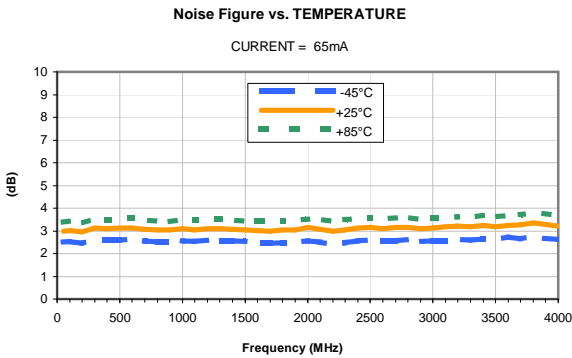
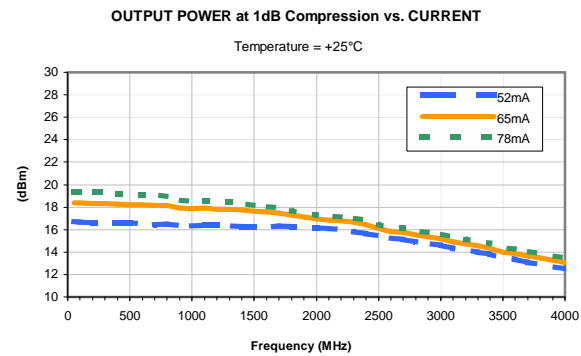
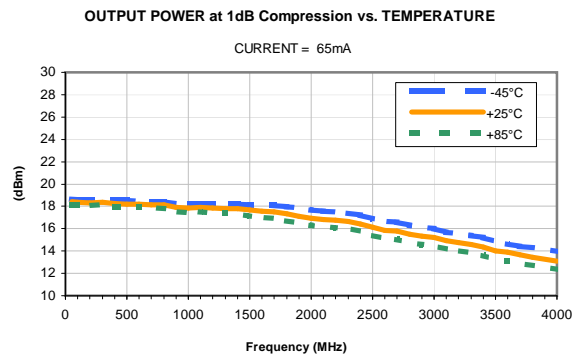
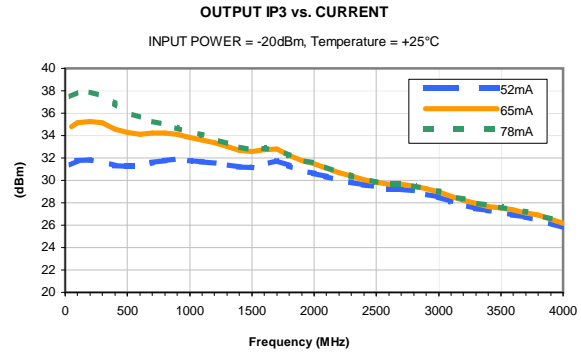
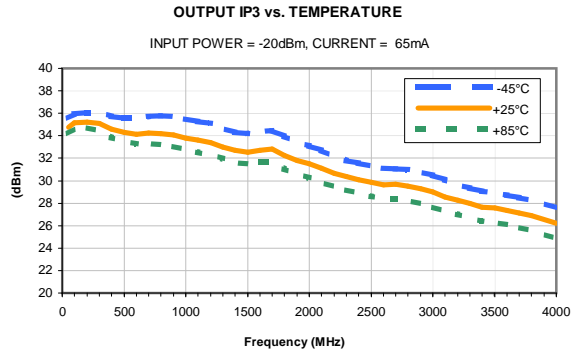

Outline Dimensions

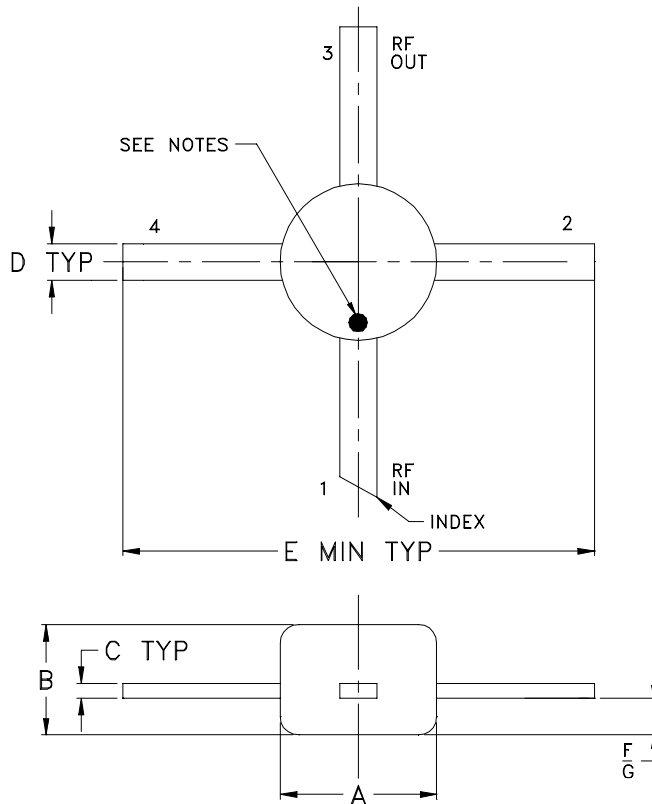

CASE#	A	B	C	D	E	F	G	WT.GRAMS
VV105	.085 (2.16)	.060 (1.52)	.008 (0.20)	.020 (0.51)	.250 (6.35)	.012 (0.30)	.025 (0.64)	.015

Dimensions are in inches (mm). Tolerances: 2 Pl. $\pm .03$; 3 Pl. $\pm .015$

Notes:

1. Case material: Plastic.
2. Termination finish:
For RoHS Case Styles: Tin-Silver alloy plate over Nickel barrier.
For RoHS-5 Case Styles: Tin-Lead plate.
3. RF input termination (1) identified by one or both of the following at factory option:
 - (a) diagonally cut termination, which be 45° (ref) in either direction;
 - (b) orientation mark on the case. Model dash number is identified by color dot or alphanumeric code on case. See specification data sheet.
4. Special Tolerances: Termination width $\pm .005$ inch, termination thickness $\pm .003$ inch.

Tape & Reel Packaging TR-F4

DEVICE ORIENTATION IN T&R



Tape Width, mm	Device Cavity Pitch, mm	Reel Size, inches	Devices per Reel	
12	8	7	Small quantity standards (see note)	20
				50
				100
				200
				500
		7	Standard	1000

Note: Please Consult individual model data sheet to determine device per reel availability.

Mini-Circuits carrier tape materials provide protection from ESD (Electro-Static Discharge) during handling and transportation. Tapes are static dissipative and comply with industry standards EIA-481/EIA-541.

Go to: www.minicircuits.com/pages/pdfs/tape.pdf



INTERNET <http://www.minicircuits.com>

P.O. Box 350166, Brooklyn, New York 11235-0003 (718) 934-4500 Fax (718) 332-4661

Distribution Centers NORTH AMERICA 800-654-7949 • 417-335-5935 • Fax 417-335-5945 • EUROPE 44-1252-832600 • Fax 44-1252-837010

Mini-Circuits ISO 9001 & ISO 14001 Certified

THIRD ANGLE PROJECTION

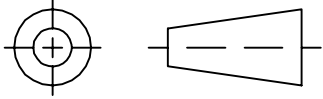

REVISIONS

REV OR	ECN No.	DESCRIPTION	DATE	DR	AUTH
	M109082	NEW RELEASE	12/29/06	AV	IG

SUGGESTED MOUNTING CONFIGURATION FOR VV105 CASE STYLE, "cb" PIN CONNECTION

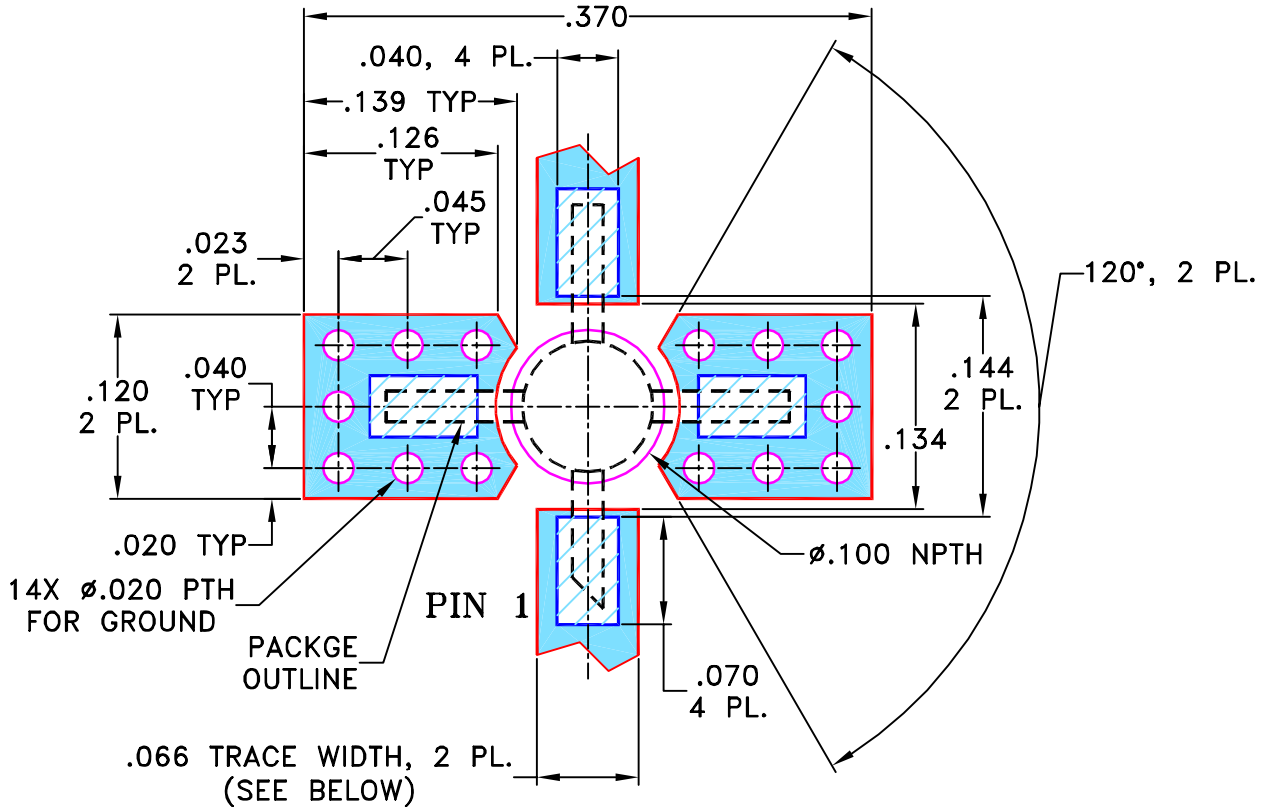

NOTES:

1. TRACE WIDTH IS SHOWN FOR ROGERS RO4350B WITH DIELECTRIC THICKNESS .030" ± .002"; COPPER: 1/2 OZ. EACH SIDE. FOR OTHER MATERIALS TRACE WIDTH MAY NEED TO BE MODIFIED.
2. BOTTOM SIDE OF THE PCB IS CONTINUOUS GROUND PLANE.

- DENOTES PCB COPPER LAYOUT WITH SMOBC (SOLDER MASK OVER BARE COPPER)
- DENOTES COPPER LAND PATTERN FREE OF SOLDER MASK

UNLESS OTHERWISE SPECIFIED	INITIALS	DATE
DIMENSIONS ARE IN INCHES TOLERANCES ON: 2 PL DECIMALS ± 3 PL DECIMALS ± .005 ANGLES ± FRACTIONS ±	DRAWN	AV 12/28/06
	CHECKED	IL 12/29/06
	APPROVED	IG 12/29/06

Mini-Circuits® 13 Neptune Avenue
Brooklyn NY 11235

PL, cb, VV105, ERA, TB-431-X+

SIZE A	CODE IDENT 15542	DRAWING NO: 98-PL-261	REV: OR
FILE: 98PL261	SCALE: 8:1	SHEET: 1 OF 1	

Mini-Circuits®
THIS DOCUMENT AND ITS CONTENTS ARE THE PROPERTY OF MINI-CIRCUITS. EXCEPT FOR USE EXPRESSLY GRANTED, IN WRITING, TO ITS VENDORS, VENDEE AND THE UNITED STATES GOVERNMENT, MINI-CIRCUITS RESERVES ALL PROPRIETARY DESIGN, USE, MANUFACTURING AND REPRODUCTION RIGHTS THERETO. THESE CONTENTS SHALL NOT BE USED, DUPLICATED OR DISCLOSED TO ANY OUTSIDE PARTY, IN WHOLE OR IN PART, WITHOUT WRITTEN PERMISSION OF MINI-CIRCUITS.

Evaluation Board and Circuit

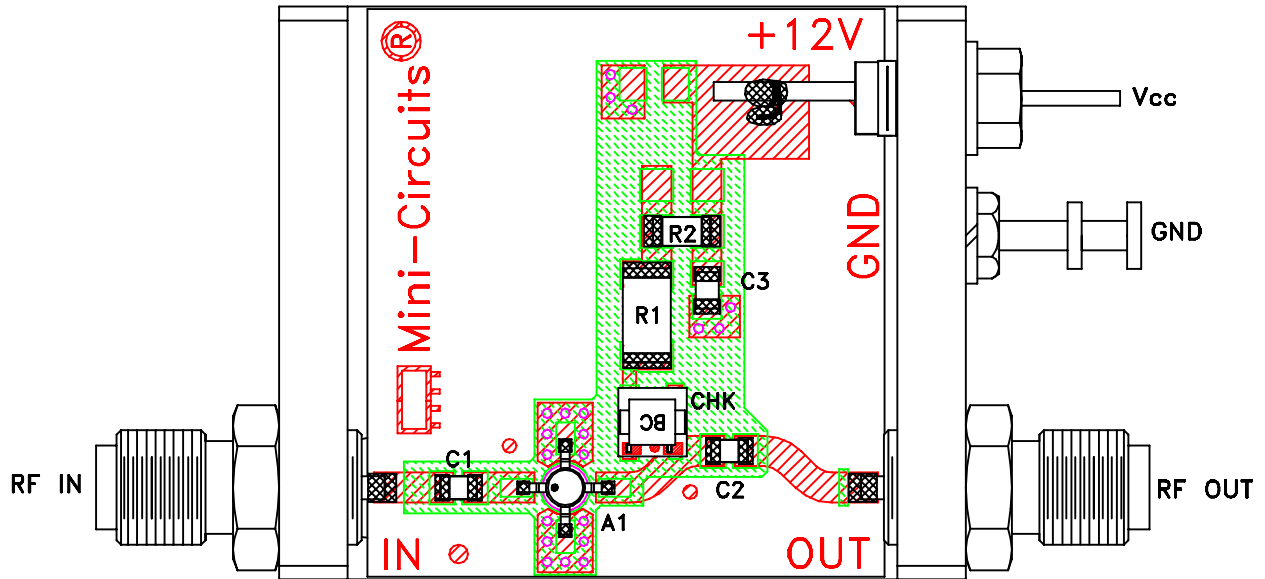

TB-431-5+

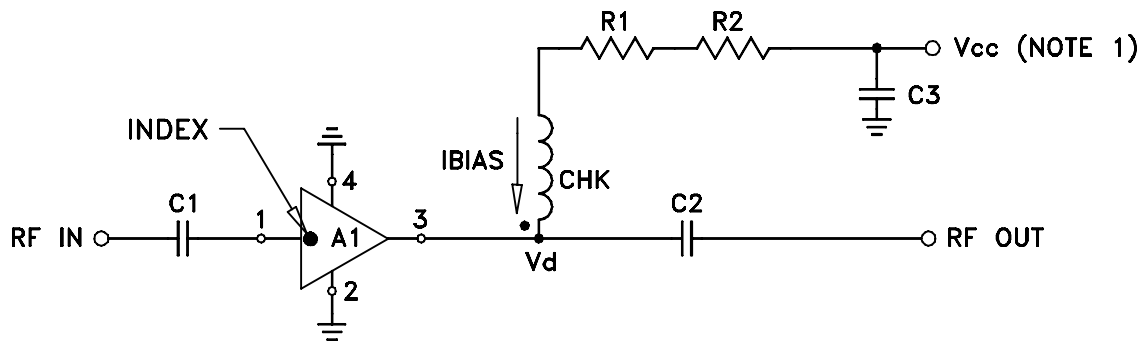

COMPONENT	VALUE
A1	ERA-5(+)
C1 (NOTE 4)	2400 pF
C2 (NOTE 4)	2400 pF
C3 (bypass)	0.1 uF
R1	110 Ohms, 0.75W
R2	0 Ohm, 0.25W
CHK	Mini-Circuits TCCH-80+

Schematic Diagram

NOTE:

1. Vcc voltage: $+12 \pm 0.2V$.
2. SMA Female connectors.
3. PCB material: Rogers R04350 or equivalent, dielectric constant=3.5, dielectric thickness=.030 inch.
4. Capacitors, C1 & C2 should be free of resonance up to the highest frequency specified.

 **Mini-Circuits®**

All Mini-Circuits products are manufactured under exacting quality assurance and control standards, and are capable of meeting published specifications after being subjected to any or all of the following physical and environmental test.

Specification	Test/Inspection Condition	Reference/Spec
Operating Temperature	-45° to 85°C or -40° to 85°C Ambient Environment	Individual Model Data Sheet
Storage Temperature	-65° to 150° C Ambient Environment	Individual Model Data Sheet
Thermal Shock	-55° to 100°C, 100 cycles	MIL-STD-202, Method 107, Condition A-3, except +100°C
Mechanical Shock	1.5Kg, 0.5 ms, 5 shock pulses, Y1 direction only	MIL-STD-883, Method 2002, Condition B, except Y1 direction only
Vibration (Variable Frequency)	50g peak	MIL-STD-883, Method 2007, Condition B
Autoclave	15 psig, 100% RH, 121°C, 96 hours	JESD22-A102, Condition C
HAST	130°C, 85% RH, 96 hours	JESD22-A110
Solderability	10X Magnification	J-STD-002, Para 4.2.5, Test S, 95% Coverage
Solder Reflow Heat	Sn-Pb Eutetic Process: 240°C peak Pb-Free Process: 260°C peak	J-STD-020, Table 4-1, 4-2 and 5-2; Figure 5-1
Moisture Sensitivity: Level 1	Bake at 125°C for 24 hours Soak at 85°C/85% RH for 168 hours, Reflow 3 cycles at 260°C peak	J-STD-020
Marking Resistance to Solvents	Isopropyl alcohol + mineral spirits at 25°C; terpene defluxer at 25°C; distilled water + proylene glycol monomethyl ether +	MIL-STD-202, Method 215



All Mini-Circuits products are manufactured under exacting quality assurance and control standards, and are capable of meeting published specifications after being subjected to any or all of the following physical and environmental test.

Specification	Test/Inspection Condition	Reference/Spec
	monoethanolamine at 63°C to 70°C	